

Crydom

See full Datasheet below...

onlinecomponents.com
THE ONLINE DISTRIBUTOR OF ELECTRONIC COMPONENTS

BUY NOW

 **MASTER**TM
E L E C T R O N I C S

BUY NOW

masterelectronics.com & onlinecomponents.com
are **authorized** e-commerce distributors
of electronic components.

crydom[®]

PowerPLUS DC Series



The Global Expert in **Solid State Relay** Technology

ABOUT US

Crydom, a brand of Custom Sensors & Technologies (CST) and **global expert in Solid State Relay Technology**, has a distinguished record of providing high quality, world class Solid State Relay and Control Products for a variety of heating, lighting and motion control applications. Crydom products, coupled with **unparalleled technical support, timely delivery and competitive pricing**, provide Crydom's clients with the innovative products and support necessary to succeed in today's competitive and fast paced global markets.

Crydom's extensive selection of standard off-the-shelf products is constantly being updated and expanded through its continuous improvement and aggressive new product development programs. Utilizing state of the art designs, materials and technology, Crydom offers a wide range of AC and DC output SSRs in industry standard Panel Mount, PCB Mount and DIN Rail packages, all **meeting global safety and standards agency requirements** such as CE, RoHS, UL, IEC, etc.

Bolstered by four decades of Solid State Relay operations experience, Crydom also specializes and encourages **adapted and fully custom-designed SSR products** for nearly any application where unique specifications and optimized performance are critical for success.

Crydom's modern purpose-built **100,000 square foot manufacturing facility** houses all aspects of its ISO certified operation including Design and Development Engineering, Manufacturing Operations and Quality Assurance, Customer Service, Finance, Marketing and General Management, permitting close coordination of all aspects of Crydom's activities. Applications Engineering and Sales support are both performed in the field to provide Crydom's Customers with the unparalleled technical and commercial support.

Following rigid design guidelines and standards, Crydom products have set the bench mark for SSR performance and reliability world wide. In addition to **award winning designs**, Crydom has acquired an impressive list of **patents** related to SSRs and Solid State Controls, while continuing to develop new circuit and technology-related inventions as part of **extensive R&D programs**.

To learn more about Crydom SSR technology and products, or how an alliance with Crydom can contribute to the success of your project, visit **www.crydom.com** or contact your authorized Crydom Distributor or Crydom Customer Service Representative today.

"POWERPLUS DC" PANEL MOUNTED DC OUTPUT SOLID STATE RELAYS

Crydom's new **"PowerPlus DC Series"** of DC output Panel mounted Solid State Relays expands Crydom's Series 1 line of DC output SSRs with new features including an optional clear IP20 "touch safe" cover, LED input status indicator and higher speed switching circuit minimizing switching losses and permitting higher frequency PWM operation. The **"PowerPlus DC Series"** also includes new models accepting AC control voltages as well as traditional DC control models.

The **"PowerPlus DC"** product line features Crydom's advanced DC switching technology utilizing low power dissipation power FETs coupled with 2.5 Kv optical coupling which provides reliable high power DC switching up to 100 amps and operating voltages to 400 VDC. Available options include a 4 to 32 VDC or 90 to 140 VAC input and a factory installed phase change thermal interface pad.

Crydom **"PowerPlus DC"** SSRs are CE certified to both the Low Voltage & EMC Directives, RoHS & China RoHS compliant, UL and cUL Recognized.

For more information on **"PowerPlus DC"** Series SSRs, contact the nearest Crydom Distributor, Representative or Local Crydom Sales Office, or visit our website at www.crydom.com



DC Series
High Current DC Output SSRs
10-100 Amp

- Logic Compatible Control Inputs of either 4 to 32 VDC or 90 to 140 VAC
- Optional IP20 Protective Cover & Thermal Interface Pad
- Optically Isolated Trigger Circuit for enhanced switching
- MOSFET Output for Low On-State Resistance
- LED Input Status Indicator
- UL Resistive Load ratings
- CE, RoHS & China RoHS compliant



Output Specifications (A)	DC60x10	DC60x20	DC60x40	DC60x60	DC60D80	DC60D100
Blocking Voltage [VDC]				60		
Operating Voltage [VDC]				7-48		
Load Current UL508 at Rated Voltage [A] (B)	10	20	40	60	80	100
Minimum Load Current [mA]				2.5		
Maximum Surge Current (10 msec) [ADC]	78	108	163	200	258	326
Maximum On-State Voltage Drop @ Rated Current [VDC]	0.33	0.35	0.62	0.62	0.75	0.59
Maximum On-State Resistance (R _{DS-On}) [mOhm]	33.4	17.6	15.6	10.4	9.4	5.9
Maximum Off-State Leakage Current @ Rated Voltage [mA]				0.1		
Thermal Resistance Junction to Case (R _{qjc}) [°C/W]	2.1	1.2	1.1	0.8	0.7	0.53
Maximum PWM [Hz] (C)	1 000	1 000	900	900	700	700
Nominal Output Capacitance [nf]				1		

Output Specifications (A)	DC100x10	DC100x20	DC100x40	DC100x60	DC100D80	DC100D100
Blocking Voltage [VDC]				100		
Operating Voltage [VDC]				7-72		
Load Current UL508 at Rated Voltage [A] (B)	10	20	40	60	80	100
Minimum Load Current [mA]				2.5		
Maximum Surge Current (10 msec) [ADC]	66	91	136	167	215	272
Maximum On-State Voltage Drop @ Rated Current [VDC]	0.32	0.34	0.6	0.6	0.72	0.56
Maximum On-State Resistance (R _{DS-On}) [mOhm]	32	17	15	10	9	5.6
Maximum Off-State Leakage Current @ Rated Voltage [mA]				0.15		
Thermal Resistance Junction to Case (R _{qjc}) [°C/W]	1.44	0.85	0.78	0.58	0.55	0.42
Maximum PWM [Hz] (C)	1 000	1 000	900	800	550	450
Nominal Output Capacitance [nf]				1		

Output Specifications (A)	DC200x10	DC200x20	DC200x40	DC200D60	DC400x10	DC400D20
Blocking Voltage [VDC]						400
Operating Voltage [VDC]						7-300
Load Current UL508 at Rated Voltage [A] (B)	10	20	40	60	10	20
Minimum Load Current [mA]						2.5
Maximum Surge Current (10 msec) [ADC]	71	81	167	245	32	48
Maximum On-State Voltage Drop @ Rated Current [VDC]	0.66	1.1	1	1.1	2.3	3
Maximum On-State Resistance (R _{DS-On}) [mOhm]	66	51	24	17	230	155
Maximum Off-State Leakage Current @ Rated Voltage [mA]						0.4
Thermal Resistance Junction to Case (R _{qjc}) [°C/W]	1.05	0.85	0.51	0.42	0.57	0.45
Maximum PWM [Hz] (C)	1 000	1 000	900	400	900	450
Nominal Output Capacitance [nf]						1

Input Specifications (A)	DCxxxDxx	DCxxxAxx
Control Voltage Range	4 - 32 VDC	90 - 140 VAC
Minimum Turn-On Voltage	4 VDC	90 VAC
Must Turn-Off Voltage	1.5 VDC	20 VAC
Maximum Reverse Voltage	-32 VDC	N/A
Minimum Input Current (for On-State)	11 mA @ 4 VDC	11 mA @ 90 VAC
Maximum Input Current	12 mA @ 32 VDC	13 mA @ 140 VAC
Nominal Input Impedance	Input is Current Regulated	
Maximum Turn-On Time (t _{od} + t _{os}) [µsec] (D)	75	10 050
Maximum Turn-Off Time (t _{fd} + t _{fs}) [µsec] (D)	320	10 080

General Notes

- (A) All parameters at 40°C unless otherwise specified.
- (B) Heat sinking required, see derating curves.
- (C) PWM ratings applies only for DC input models. A minimum of 8 Vdc have to be applied in the control. For more information see datasheet.
- (D) See Switching Time Diagram. V_{OUT} is typical of a resistive load.

DC Series



General Specifications (A)

	DCxxxDxx	DCxxxAxx
Dielectric Strength, Input-Output to Baseplate (50/60Hz) [Vrms]		2500
Minimum Insulation Resistance (@ 500 VDC)		10 ⁹
Maximum Capacitance, Input to Output [pF]		10
Ambient Operating Temperature Range [°C]	-30 to 80	
Ambient Storage Temperature Range [°C]		-40 to 125
IP ratings	IP00 / IP20 for suffix C	
Status Indicator Display	Green (On)	
Weight (typical) [oz] (gr)	2.64 (75)	2.992 (85)
Encapsulation	Epoxy Free	Thermally Conductive Epoxy
Output Terminals	Screw / Combo Drive 8-32	
Input Terminals	Screw / Combo Drive 6-32	
Humidity	5 to 85% HR	

Part Number Nomenclature (E)

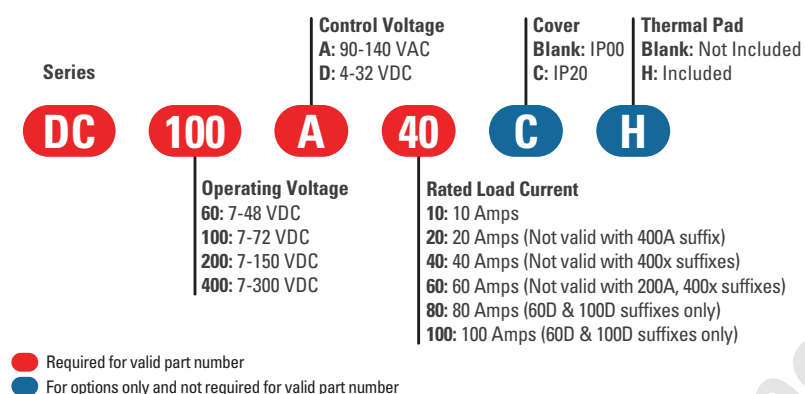
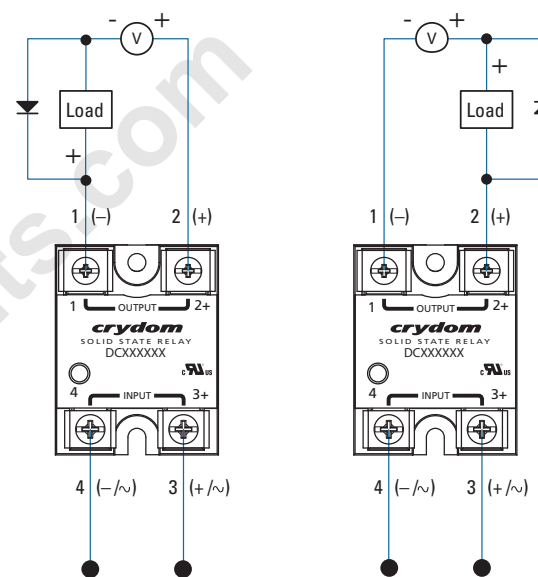

TABLE 1. Part Number Availability Table

Rated Operating Voltage	Control Voltage	Operational Current					
		10 A	20 A	40 A	60 A	80 A	100 A
60 VDC	4-32 VDC	♦	♦	♦	♦	♦	♦
	90-140 VAC	♦	♦	♦	♦	♦	♦
100 VDC	4-32 VDC	♦	♦	♦	♦	♦	♦
	90-140 VAC	♦	♦	♦	♦	♦	♦
200 VDC	4-32 VDC	♦	♦	♦	♦		
	90-140 VAC	♦	♦	♦			
400 VDC	4-32 VDC	♦	♦				
	90-140 VAC	♦					

Wiring Diagram (F, G)



Mechanical Dimensions

Tolerances: ±0.02 in / 0.5 mm
 All dimensions are in: inches [millimeters]

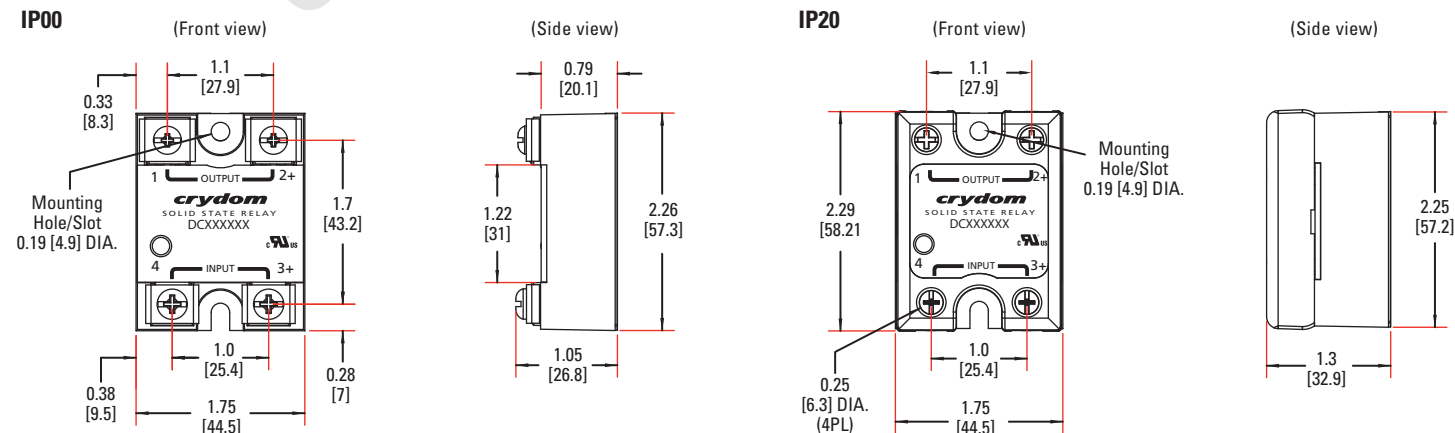

(E) Not all part combinations available, see TABLE 1.

(F) Inductive loads must be diode suppressed as indicated.

(G) Load can be wired to either terminal 1 or terminal 2. Proper polarity must be observed all the time for the power supply and load with terminal 2 being positive with respect to terminal 1.

Block Diagram

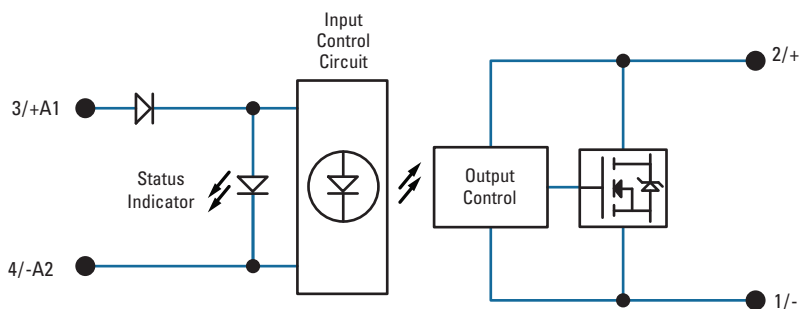

Switching Time Diagram

Turn-On Time Maximum = $t_{od} + t_{os}$
Turn-Off Time Maximum = $t_{fd} + t_{fs}$

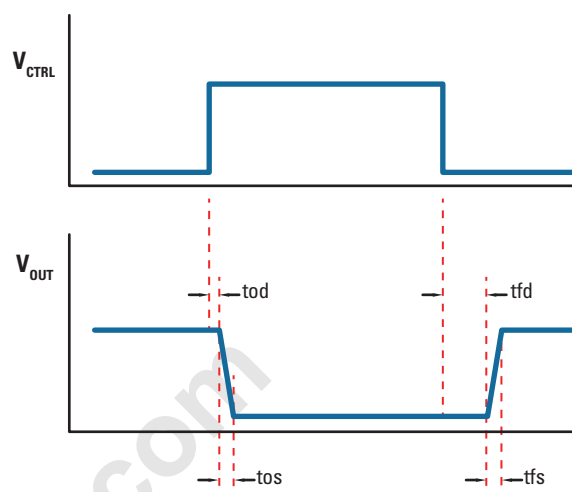
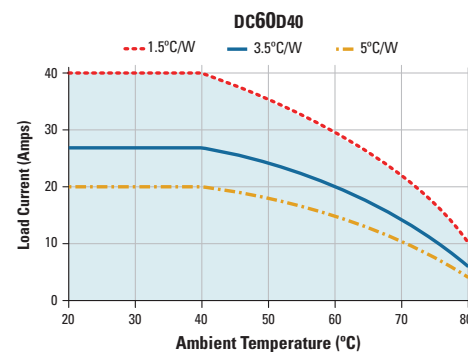
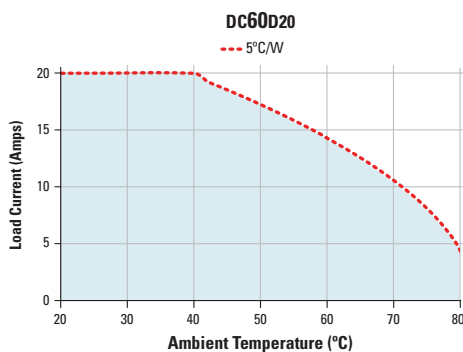
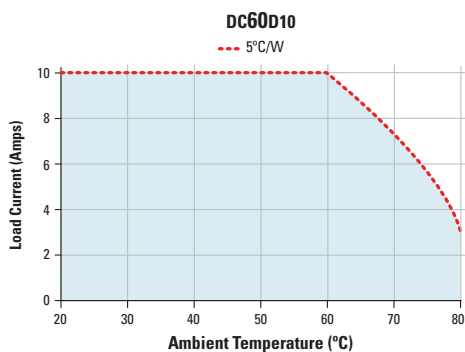

TABLE 2. Compatible Accessories (H)

PowerPLUS DC Series Part No.	Heat Sinks							HK1	TRM1 (J) TRM6
	5.0° HS501DR	3.5° HS351 HS351DR	2.0° HS202 HS202DR	2.0° HS201 HS201DR	1.5° HS151 HS151DR	1.0° HS103 HS103DR	0.5° HS053		
DC60x10 / DC100x10	♦							♦	♦
DC60x20 / DC100x20	♦							♦	♦
DC60x40 / DC100x40	♦	♦			♦			♦	♦
DC60x60 / DC100x60	♦		♦			♦		♦	♦
DC60D80 / DC100D80	♦	♦			♦			♦	♦
DC60D100 / DC100D100	♦	♦			♦			♦	♦
DC200x10	♦							♦	♦
DC200x20	♦	♦						♦	♦
DC200x40			♦		♦		♦	♦	♦
DC200D60		♦	♦		♦			♦	♦
DC400x10	♦	♦			♦			♦	♦
DC400x20	♦		♦		♦			♦	♦

(H) Thermal pad and IP20 plastic cover are available as options for this family. See Part Number Nomenclature for information on how to order them.
(J) Compatible with IP00 versions only.

Derating Curves DC Input



DC Series

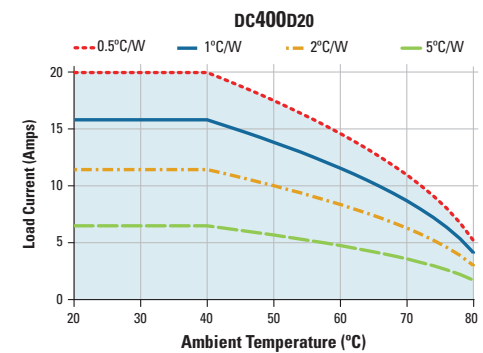
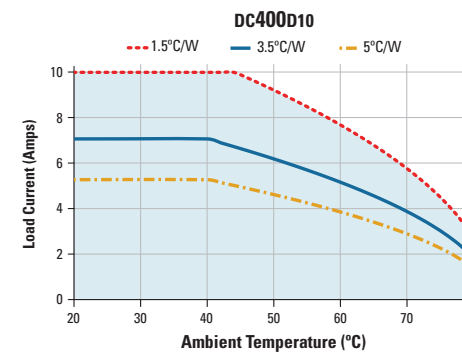
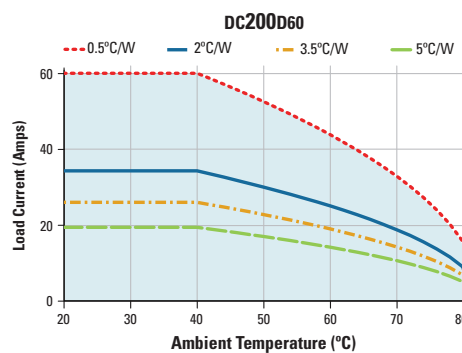
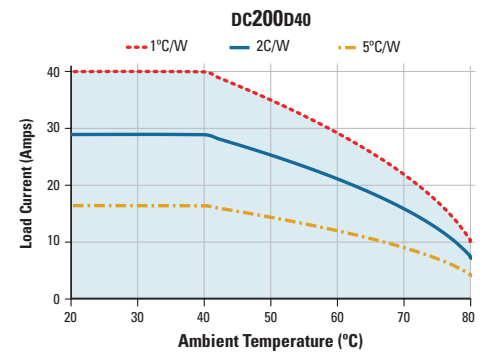
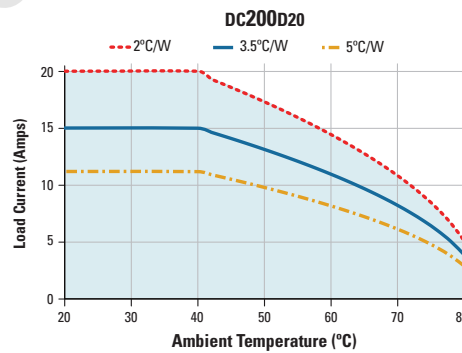
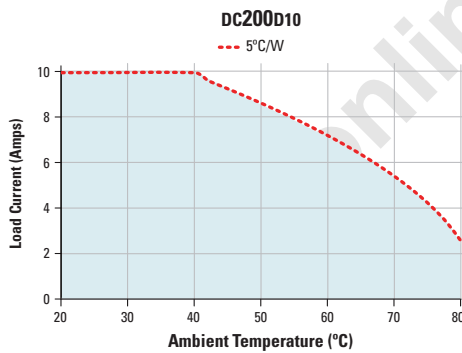
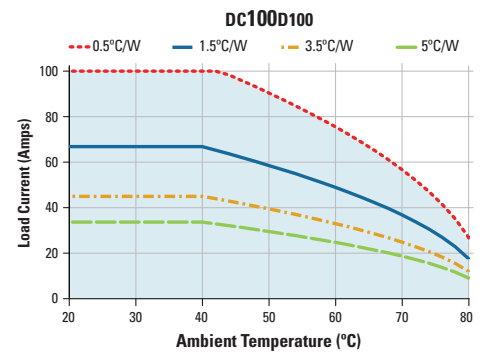
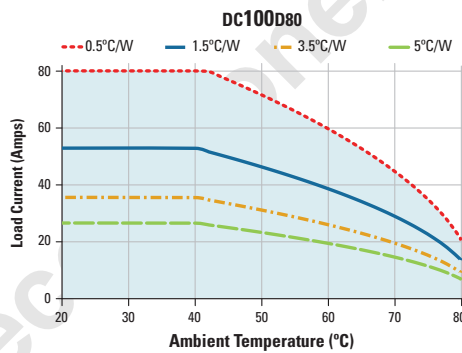
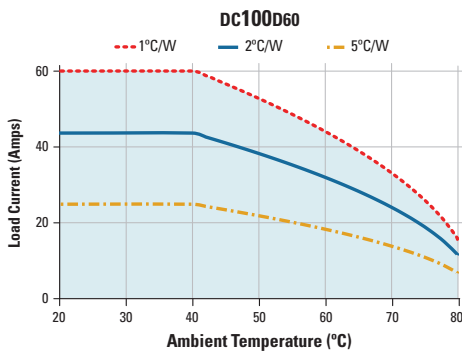
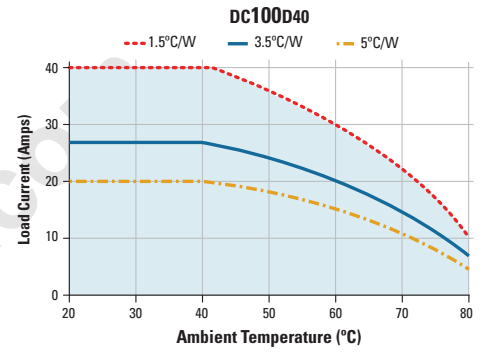
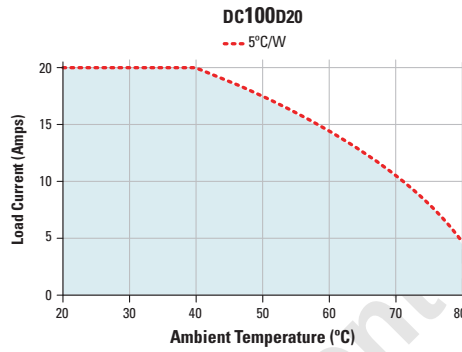
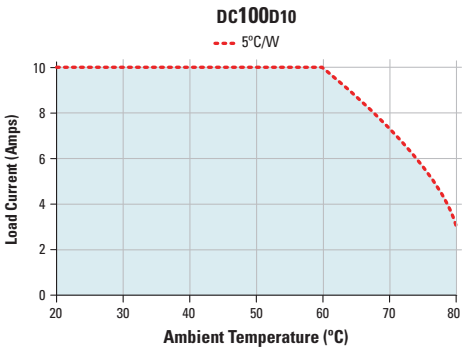
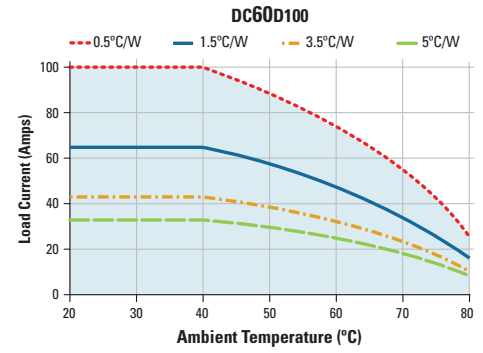
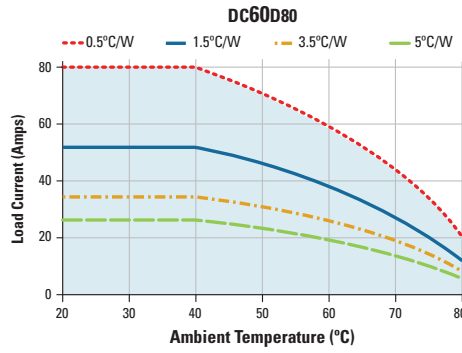
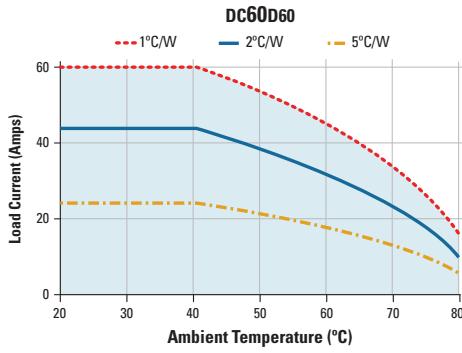

DC Series



Derating Curves

AC Input

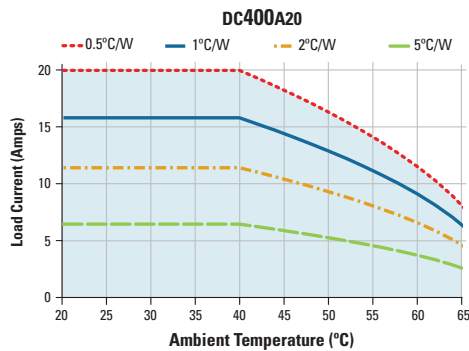
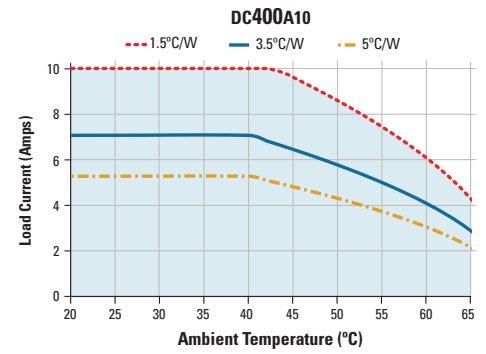
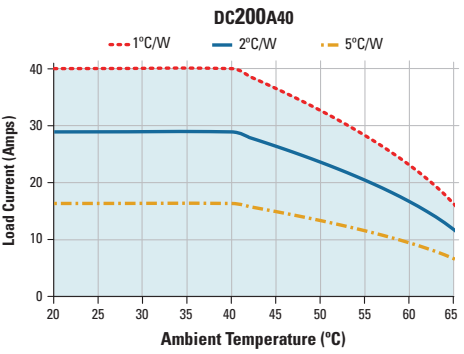
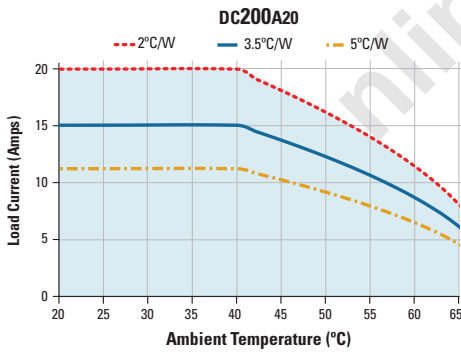
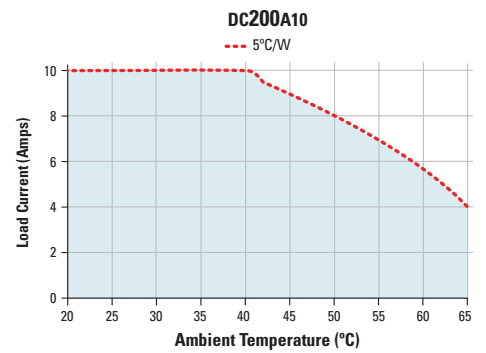
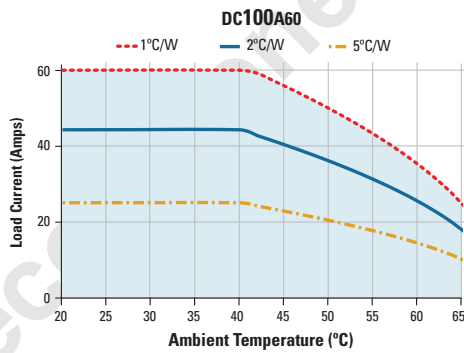
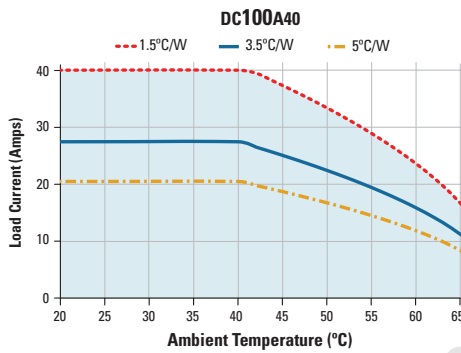
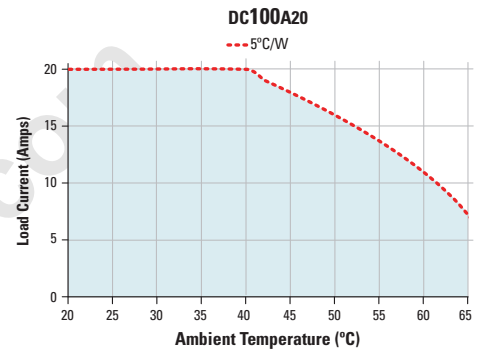
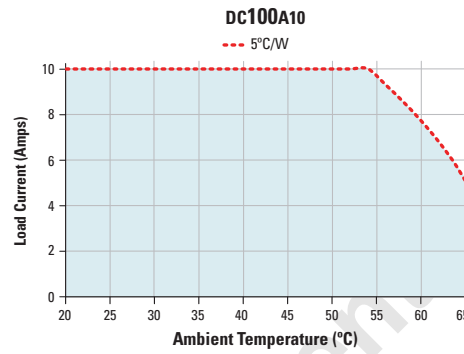
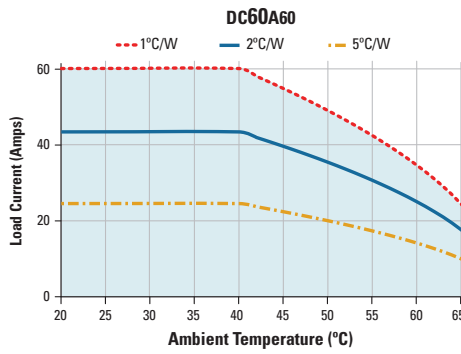
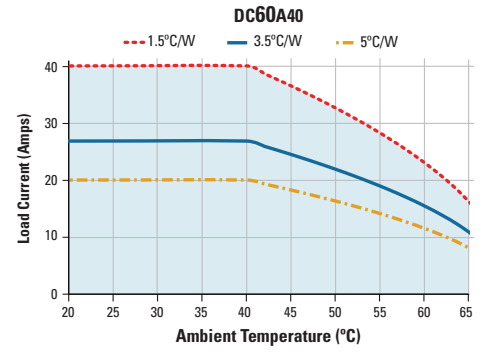
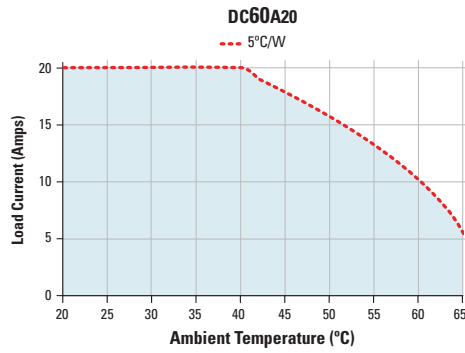
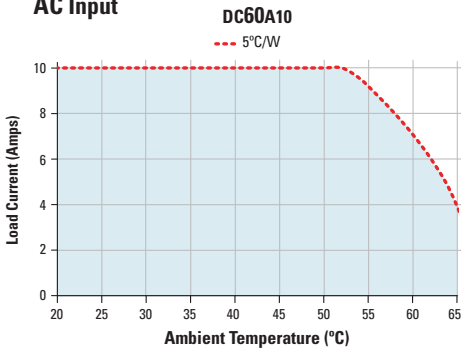

crydom®

AMERICA



United States & Canada

Crydom Inc
2320 Paseo de las Americas,
Suite 201
San Diego, CA 92154

Sales Support:
Tel.: +1 (877) 502 5500
Fax: +1 (619) 210 1590
sales@crydom.com

Technical Support:
Tel.: +1 (877) 702 7700
support@crydom.com

Mexico

**Automatismo Crouzet
S.A. de C.V.**
Calzada Zavaleta 2505-C Col
Sta Cruz Buenavista C.P.
72150 - Puebla

Sales Support:
Toll free: 01 800 087 6333
Tel.: +52 (222) 409 7000
Fax: +52 (222) 409 7810
sales-mx@crydom.com

Southern & Central American Countries CST Latinoamerica

Alameda Rio Negro, 1030,
18º andar – Conjunto 1803
CEP: 06454-000
Barueri - São Paulo
Brasil

Tel.: +55 (11) 2505 7500
Fax: +55 (11) 2505 7507
info@cst-latinoamerica.com

EUROPE, MIDDLE EAST & AFRICA



United Kingdom

Crydom SSR Ltd
Arena Business Centre
Holyrood, Close
Poole, Dorset BH17 7FJ

Sales Support
Tel.: +44 (0) 1202 606030
Fax: +44 (0) 1202 606035
sales-europe@crydom.com

Tech Support
support-europe@crydom.com

Austria & Switzerland

Tel.: +44 (0) 1202 606030
Fax: +44 (0) 1202 606035
vertrieb@crydom.com

Belgium

Tel.: +32 (0) 2 460 4413
Fax: +32 (0) 2 461 2614
sales-europe@crydom.com

France

Tel.: +33 (0) 810 123 963
Fax: +33 (0) 810 057 605
sales-europe@crydom.com

Germany

Tel.: +49 (0) 180 3000 506
Fax: +49 (0) 180 3205 227
vertrieb@crydom.com

Italy

Tel.: +39 (0) 2 665 99 260
Fax: +39 (0) 2 665 99 268
sales-europe@crydom.com

Spain

Tel.: +34 902 876 217
Fax: +34 902 876 219
sales-europe@crydom.com

Netherlands

Tel.: +31 (0) 71 582 0068
Fax: +31 (0) 71 542 1648
sales-europe@crydom.com

Middle East, Africa & Other European Countries

Tel.: +44 (0) 1202 606030
Fax: +44 (0) 1202 606035
sales-europe@crydom.com

ASIA PACIFIC



China & Hong Kong

**Custom Sensors &
Technologies Asia
(Shanghai) Ltd.**
13th floor
Chang Feng International
Tower
89 Yunling Road (East)
Putuo District
Shanghai, 200062

Sales Support
Tel.: +86 (0) 21 6065 7725
Fax: +86 (0) 21 6065 7749
sales-cn@crydom.com

Tech Support
support-cn@crydom.com

Taiwan & Japan

**Custom Sensors &
Technologies**
2F, No. 39, Ji-Hu Road
Nei-Hu Dist.
Taipei 114

Tel: +886 2 8751 6388
Fax: +886 2 2657 8725
taiwan@cstsensors.com

South Korea

**Custom Sensors &
Technologies**
2F, Jeil Bldg.,
94-46 Youngdeungpo-dong
7-ga Youngdeungpo-gu,
Seoul, 150-037
Tel.: +82 2 2629 8312
Fax: +82 2 2629 8310
korea@cstsensors.com

India

CST Sensors India Pvt Ltd
4th Floor, Trident Towers,
No. 23, 100 Ft- Ashoka Pillar Road,
2nd Block, Jayanagar,
Bangalore- 560011
Tel: +91 (80) 4113 2204 /05
Fax: +91 (80) 4113 2206
india@cstsensors.com

South East Asian & Pacific Countries

**Custom Sensors &
Technologies**
2F, No. 39, Ji-Hu Road
Nei-Hu Dist.
Taipei 114, Taiwan
Tel.: +886 2 8751 6388 ext.131
Fax: +886 2 2657 8725
eap@cstsensors.com

