

**1080P
 HDMI 3D
 Supported
 Technology**

Interface Equipment
 In Your AV Rack
 With Calrad



Video Scalers
 IR Distribution
 HDMI Accessories
 Audio-Video Baluns
 Distribution Amplifiers
 Audio-Video Wall Plates
 Networking Accessories
 HDTV Cables & Adapters
 Connectors - Jacks - Plugs



Home Theater Integration Products



CATALOG

61



TEAM CALRAD

As many new technologies surface and push their way into the mainstream, the technical challenges and 'techno bable' becomes blurred and difficult to manage and understand. Calrad continues to expand its product line into these new technologies, while providing a support system of educated sales and technical staff professionals to answer all your questions. For more than 5 decades Calrad continues to build long term relationships with our customers. We provide a wide range of products with friendly, personal hands on service everyday that we believe are the basic principles that continue to build our company. You can always expect high quality products and customer service with the promise we will always try our best to satisfy your expectations. We appreciate your continued support and hope you put Calrad at the top of your list when purchasing electronic parts & accessories.

A handwritten signature in white ink, likely belonging to Robert Shupper.

Robert Shupper
President, Calrad Electronics

Plasma \ LCD Display Connector Backplane

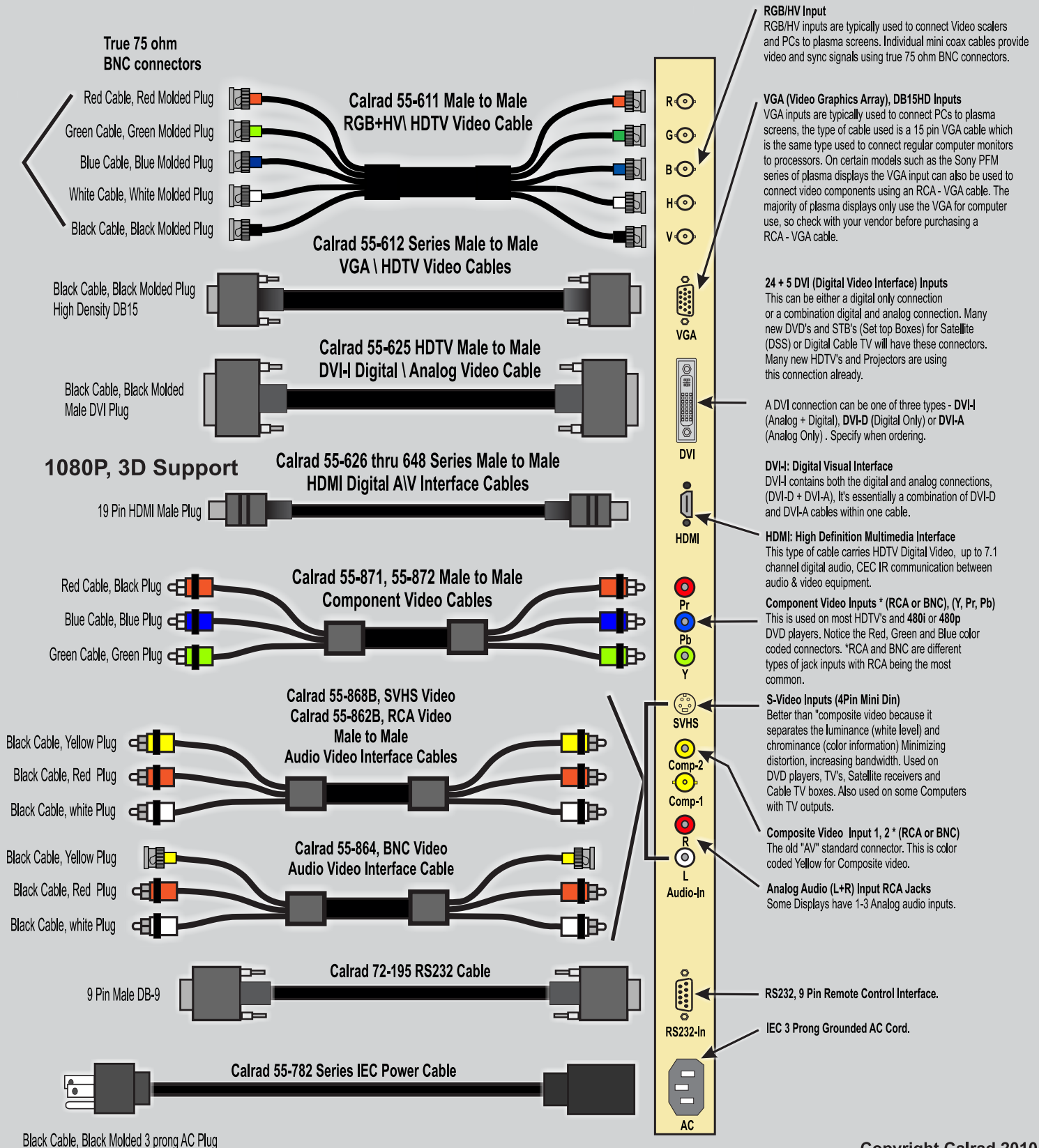

Catalog

61

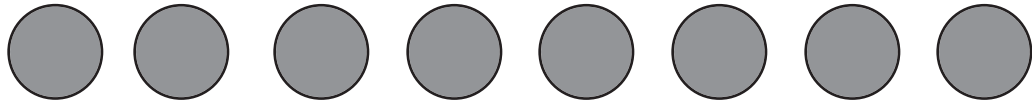

Calrad has Cables, Connectors and Adapters that support and interface with all the New Technologies.....!!!!



Calrad products are available in bulk and in retail packaging

get your Calrad catalog 61 on disk for quick and easy viewing on your laptop or desktop computer.

Table of Contents

SALES AND ORDERING CONDITIONS	a.1
10 SERIES , mICS & ACCESS., AuDIO pREAmPS & mIxERS, AuDIO CAbLES, f lBER OpTIC AmpS & CONvERTERS ...	1
15 SERIES , hEADphONES & ACCESSORIES	13
20 SERIES , SpEAKERS & SpEAKER SySTEMS	16
25 SERIES , ATTENUATOR CONTROLS & pOTENTIOMETERS	20
28 SERIES , DECORA WALL pLATES & jACKS	25
30 SERIES , pLuGS, jACKS & CONNECTORS, AuDIO & vIDEO	35
35 SERIES , AuDIO-vIDEO ADAPTERS	48
40 SERIES , AuDIO-vIDEO COMpONENT, hDml, vGA AmpLif IERS, bALuNS, SwITChERS, SwITChES	56
42 SERIES , IpAD, IpOD ACCESSORIES	101
45 SERIES , pOWER SuppLIES, TRANSf ORMERS & INVERTERS	102
55 SERIES , AuDIO, vIDEO Rf CAbLES & WIRE	110
60 SERIES , pANEL mETERS	138
65 SERIES , TEST EquIpment vOm mETERS, hDml TESTER	139
70 SERIES , TELEphONE ACCESSORIES	141
72 SERIES , NETWORK CAT 5 pRODuCTS	148
75 SERIES , Tv & vIDEO Rf ACCESSORIES	157
80 SERIES , AuDIO & vIDEO CLEANING ACCESSORIES, pREAmPS	170
85 SERIES , kNOBS & DIALS	172
90 SERIES , L.E..D. LIGHtS, L.E.D. f LASHLIGHtS, hARDWARE, TOOLS, ChASSIS bOXES, LAmpS, ETC.	173
92 SERIES , f LASHLIGHtS, IR DISTRIbuTION, LGht EmITTING DIODES & hOLDERS	184
95 SERIES , ALARm & CCTv SECuRITy & pAGING SySTEMS, AC ACCESSORIES	188
99 SERIES , DRILL bITS	179
AppENDix : NumERICAL & ALphAbETICAL INDExES	199

CALRAD

Warranty & Company Information

Warranty policy

We guarantee all Cal rad products to be free of defects in workmanship and material for 90 days after sale to your customer. We will replace or repair, at our option, any item which should prove to be defective during this period, providing there is no evidence of customer misuse, alteration of circuits or wiring or operation in excess of the rated tolerances. Warranty items must be returned to us freight prepaid. incomplete items such as missing parts and no cartons will be repaired and returned as received. You should accumulate your returns in order to minimize the high cost of freight.

Address & Telephone

CALRAD Engineered Electronic Products

819 north Highland avenue, Los angeles, California 90038-3488

Toll Free: (800) 821-8536

Information: (323) 465-2131

Facsimile: (323) 465-3504

Web Site: www.calrad.com

E-mail: calradelectronics@calrad.com



visit Calrad on the web at: www.calrad.com

CALRAD

Sales & Ordering Details

Custom Services

With over 50 years of electronic product development, Calrad's manufacturing facilities in the united states and overseas, deliver custom engineering and prototype development for all types of electronic parts. Our in-house engineers will design and fabricate first article prototypes, as well as provide technical and mechanical drawings as per your specifications. Calrad's experienced staff uses state-of-the-art equipment to offer top quality design and product to its customers. Call Calrad today for a quote on all your electronic needs.

- Custom cable assemblies for audio, video, and communication
- Connectors and jacks manufactured to your specifications
- plug-in the wall power supplies with ends molded to your specifications
- New product development, small and large quantities
- plastic injection molding, chassis fabrication, and die stamping
- CAD, printed circuit board development
- Complete product inspection and testing

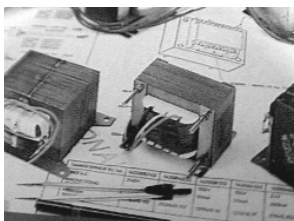

CALRAD

Sales & Ordering Details



Order Information

Open Account:

Calrad's terms are net 30 days. If you wish to open a new account, please request a credit application. You may return your application by Fax at (323) 465-3504. Processing your credit application takes approximately 7-10 working days.

C.O.D.:

All new accounts are shipped the first order C.O.D., unless other terms are approved prior to shipping. C.O.D. payment must be made with a business check or cash.

Order Minimums:

Check with your Calrad sales representative.

Sales Tax:

Sales tax will be added to all sales within California unless a resale Certificate is on file with Calrad.

Back Orders:

Out-of-stock merchandise will be put on back order. Back orders over \$25.00 will be shipped automatically. All back orders will be cancelled after 90 days, unless we are otherwise instructed.

CALRAD Custom Orders:

If you don't see an item you need, just call our sales staff and inquire about our custom orders. Many items can be custom tailored by Calrad to suit your specific requirements.

Shipping:

Orders will be shipped as soon as possible. All UPS Red Label, Blue Label, and 3rd Day take shipping priority. We will be glad to add additional items after you place your order, but this may delay shipping.

Credits & Returns:

Returned merchandise must be accompanied by a Calrad return authorization number. To obtain a number, call Calrad during business hours. You may return current and non-discontinued items within 90 days of purchase. All returned merchandise must be in the original packaging and must be in resalable condition. A 15% restocking charge will be deducted from your credit. All defective merchandise may be returned to Calrad, but also requires a return authorization number. All defective items will be repaired or replaced at Calrad's discretion. If an item has been used for other

Cont...

CALRAD

Sales & Ordering Details

than its designed purpose, you will be advised of any charges and it will be repaired and the repairs will be billed accordingly.

Warranty:

We warranty all merchandise from defects in material and workmanship for a period of ninety days. any product that is misused or altered will be repaired or replaced at Cal rad's discretion. We require all warranty items to be returned freight pre-paid - no C.o .d.'s will be accepted.

misc. Information

About CALRAD's Catalog No. 61:

as in the past years, this catalog brings to you our most current product line. if you need any additional information about a particular product, please call our order telephone numbers and request new product literature; ask your local Cal r ad sales representative; or call Cal r ad's sales department. additional copies of our current catalog are available upon request by telephone, fax or E-mail.

Catalog 61 on Disk:

Catalog 61 and any new product updates are available in digital format on Cd-r om, the format is Pd F, this format provides easy access to copy text and or graphics to be used for printed literature and website designs. if specific graphic images are required for reproduction of Calrad products, please contact a Calrad sales representative or assistance.

Inquiries & Orders:

Please feel free to inquire about billing by calling: (323) 465-2131 during regular business hours; 8:00 a.m. to 4:30 p.m., Pst , Monday thru Friday. o rder business hours: 7:00 a.m. to 4:30 p.m. Pst .

You may FaX your orders anytime day or night at: (323) 465-3504

Catalog Errors:

We have tried to make this catalog error-free. if, however, there is an error in product information or pricing, our sales staff will try to inform you when you place your order.

Pricing:

Prices are current as of the day the price sheet was printed. Prices, however, are subject to change without notice.

We welcome your comments and questions. Please direct them to our sales staff, by FaX or telephone. We always want you to be satisfied with your order.



**Catalog 61
Available on Disk**

CALRAD

10 Series - Wireless Microphones

10-120

WIRELESS MICROPHONE RECEIVER

This professional receiver is designed with the latest wireless technology. The low drop-out-free RF is excellent under adverse conditions. Audio performance is comparable to more expensive systems. It has "TRUE DIVERSITY" reception for excellent RF performance.

Specifications:

Operational Frequencies available* VHF 169-216 MHz
 Working Range Up to 300' under average conditions
 Distortion Less than 1% (+/-15 KHz dev.)
 Frequency Response 40Hz-15KHz (+/-3dB)
 Dynamic Range Better than 100dB
 Signal to Noise Ratio Better than 95dB
 Noise Reduction 2:1 Logarithmic compressor/expander
 Size (mm) 280 W X 120 D X 37 H
 Oscillator/Modulator Crystal controlled/Fm
 Color Black

Image Rejection Better than 60 dB
 Reception Sensitivity Better than 15dB uv
 Reception Selectivity +/-60 KHz
 Audio Output adjustment Min-30 dB, center 0dB,
 Audio Output Impedance 2.2KΩ unbalanced
 Power Requirements 12 Vdc-300mA

Weight 29 oz. (830 grams)



*25 separate frequencies available.

CH	MHz	TV	CH	MHz	TV	CH	MHz	TV	CH	MHz	TV
A1	169.505	NONE	B5	177.650	7	D2	188.200	9	E3	196.800	10
A3	171.045	NONE	C1	181.400	8	D3	190.600	9	E4	197.325	10
A4*	171.905	NONE	C2	184.025	8	D4	191.300	9	E5	193.825	10
B1	175.400	7	C3	185.125	8	D5	189.325	9	E6	195.975	10
B2	178.225	7	C4	181.850	8	D6	190.075	9			
B3	179.200	7	C5	182.550	8	E1	194.400	10			
B4	176.425	7	D1	187.800	9	E2	195.425	10			

*171.905MHz is the default frequency.

10-127

WIRELESS MICROPHONE SYSTEM

This professional quality VHF microphone system has a range of over 250 feet. With two switchable frequencies for the cleanest sound at an affordable price. Has clip on microphone. Ideal for camcorder use. A monitor earphone is included.

Specifications:

TRANSMITTER		RECEIVER	
Switchable Frequencies	F1-169.445 MHz + F2-170.245 MHz	Reception system	Double superheterodyne system
Sensitivity	94dB SPL at +/- 2.5KHz deviation	Frequencies	F1 169.445 MHz + F2 170.245 MHz
Power supply	one 9 volt battery (not included)	Sensitivity	2uV at S/N 40dB
Power consumption	30 mA	Power supply	one 9 volt battery (not included)
Dimensions	86 x 60 x 21.5 mm	Power consumption	25mA
Weight	98 grams	Monitor output	voltage: 1v (load 30 Ω)
Microphone	Electret condenser		modfreq: 1 KHz<dev +/- 7 KHz
Color	Black	Microphone output	voltage: 8mV (load 10K Ω)
			impedance 300 Ω
		Dimensions	86 x 60 x 21.5 mm
		Weight	128 grams (including battery)
		Accessories supplied	Earphone



10-131

WIRELESS TRANSMITTER

This wireless transmitter has a clip on lapel microphone ideal for many uses. This microphone has a range of over 200 feet. It has two switchable frequencies for the clearest signal available. For use with the 10-120 receiver. Unit shipped with default frequency of 171.905 MHz.

Specifications:

Operational Frequencies available. 169 - 216 MHz
 Sensitivity 94dB SPL @ +/- 2.5KHz deviation
 Power supply one 9 volt battery (not included)
 Power consumption 30mA
 Color Black

Dimensions 86 x 60 x 21.5 mm
 Weight 4 oz. (112 grams)
 Microphone Omni Directional
 RF output power 30Mw (50Mw max.)



10 Series - Wireless & Shotgun Microphones

10-130

WIRELESS MICROPHONE

This is a quality microphone for use with the 10-120 receiver. It delivers a 200 foot range for use with videography and public speaking. Its clean crystal controlled output is equal to more expensive systems. Unit shipped with default frequency of 171.905 MHz. See page 1 for frequency chart.

Specifications:

Operational Frequencies available..... 169 - 216 MHz	Weight	7.5 oz. (213 grams)	
Sensitivity	94dB SPL at +/- 2.5 KHz deviation	Microphone	unidirectional-dynamic
Power supply.....	one 1.5v AA battery (not included)	RF output power.....	10Mw (50Mw max.)
Power consumption.....	30mA	Color	Black



10-126

WIRELESS MICROPHONE SYSTEM

This handheld microphone is ideal for videographers and public speaking. The VHF system has two switchable frequencies for selecting the cleanest sound and delivers a crystal clear sound range of more than 200 feet. The transmitter is built into the handle of the microphone with no wires extending out of the base. The receiver has a cord terminated by a 3.5mm plug.

Specifications:

TRANSMITTER		RECEIVER	
Frequencies F1 - 169.445 MHz + F2 - 170.245 MHz		Frequencies F1 - 169.445 MHz + F2 - 170.245 MHz	
Sensitivity.....	94dB spl ± 2.5KHz dev	Sensitivity	2µV at S/N 40dB
Microphone	unidirectional-dynamic	Reception system	double superheterodyne
Power supply.....	one 1.5v AA battery (not included)	Power supply.....	one 9v battery (not included)
Power consumption.....	100mA	Power consumption.....	25mA
Weight	170 grams (including battery)	Weight	128 grams (including battery)
Battery Life.....	6-8 hours (alkaline battery)	Battery Life.....	6-8 hours (alkaline battery)
Color.....	Black	Color	Black



10-17

SHOTGUN MICROPHONE

This is a high quality sound locating shotgun microphone. It is equipped with a high quality internal amplifier and earbud type earphones. Can be easily mounted on camcorders, binoculars, or hand-held. It has an adjustable volume control for clear output. The supercardioid pattern is designed for medium range frequencies to isolate and pick up human voices at directional short distances.

Specifications:

Microphone	Electret Condenser	Weight.....	65 grams (incl. battery & earphones)
Pattern	Unidirectional Supercardioid	Earphones	Inner-ear Type Stereo -32 Ω
Output Level	5m watts MA at earphone	Measurements.....	238 (L) X 30 (H) X 17 (W)
Acoustic Gain	50dB	Accessories	Earbud Headphones, Mounting Hardware, and Directional Tube, Thread Adapter
Frequency Response	200-15 KHz	Windscreen Color	Black
Power Source	1 AAA Battery Included	Microphone Color	Black
Battery Life.....	100 hours (continuous operation)		



CALRAD

10 Series - Shotgun Microphones

10-10

SUPER CARDIOID SHOTGUN MIC

Super directive use. Can pick up objective sound clearly even in noisy environments. Shakeproof holder acts as a vibration damping mechanism and helps eliminate unwanted mechanical and motor noises. Impedance 600Ω (1 KHz). Complete with Case and Windscreen, 3.5 mm plug.

Specifications:

Type.....	Electret Condenser Microphone	Frequency Range.....	50 Hz-10 KHz
Directivity.....	Super Directional	Std. Working Voltage.....	1.5V (DC)
Sensitivity.....	-60 db (1 KHz 0 dB = 1V/u Bar)	Current Drain.....	1 mA Max
Output Impedance.....	600Ω (1 KHz)	S/N Ratio.....	40 dB or more (1 KHz, JISA-curve)
Battery type Size	"AA" Penlite Cell 1.5Vdc (included)	Color.....	Black

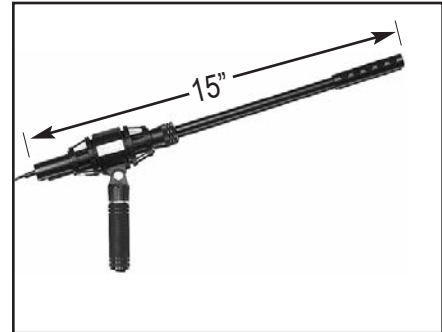

10-15A

SUPER CARDIOID SHOTGUN MIC

This microphone is for Super-Directive use with high sensitivity and extremely low noise. It can pick up clearly and naturally the object's sound even in noisy environment of both short and long distance. The 10-15 microphone is designed primarily for operational efficiency and well suited to outdoor sports broadcast, stage, video and movies. Can be hand held, stand mounted or mounted on video or movie equipment. Terminated to a 3.5mm plug.

Specifications:

Type.....	Super Cardioid Electret Condenser	Output Impedance.....	For short distance: 520Ω
System	Switchable uni-directional system for long and short distance		For long distance: 2.3KΩ
Sensitivity: For short distance:	-66 dB (1 V/u bar 1 KHz)	Sound Pressure Level.....	120 dB Max
For long distance:	-56 dB (1 V/u bar 1 KHz)	Signal to Noise Ratio.....	40 dB or More
Frequency Response:	80 Hz-12,000 Hz	Cable.....	coiled with 3.5 mm plug
Power Source	1.5Vdc, AA Size Battery (not included)	Accessories.....	Wind Screen and Mic Holder
		Color.....	Black

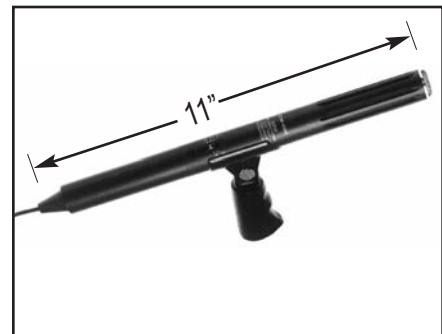

10-91

MINIATURE TIE CLASP MICROPHONE

Extra small, only 3/8" diameter. Excellent voice quality makes this lavalier microphone very versatile. Great for interviews, P.A., radio and T.V. network use, where free use of hands is necessary. Complete with battery, windscreen, tie clip, terminated to a 3.5 mm plug. 10 ft. cord.

Specifications:

Type	Electret Condenser Microphone	Impedance.....	600Ω at 1 KHz
Frequency Response.....	50 Hz-10 KHz	Package.....	Bliester (Hanger Type)
Sensitivity.....	-60 dB ± 3 dB	Power Supply.....	1.5V Button Cell (included) LR41
Length.....	1 1/4"	Polar Pattern.....	Omni-Directional

10-91-BAT replacement battery for 10-91 microphone

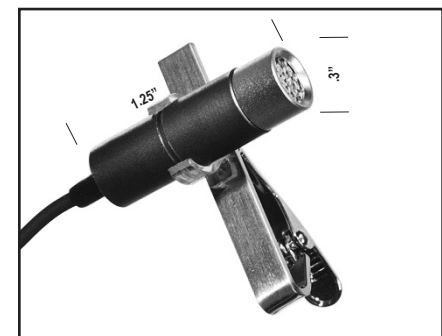

10-90

MICROPHONE

Excellent voice quality makes this lavalier microphone very versatile. Great for interviews, P.A., radio and T.V. network use, where free use of hands is necessary. Complete with battery, windscreen, tie clip, terminated to a 1/4" mono plug.

Specifications:

Polar Pattern.....	Omni-Directional	Impedance.....	600Ω at 1 KHz
Frequency Response.....	50-64 dB / 50-16,000 Hz	Power Supply.....	1.5V LR-44 A-type / 1.5V
Sensitivity.....	-64 dB / 01 KHz	Cable with 1/4" mono plug.....	6m (20 feet)
Sound Noise Level.....	Max. 130 dB		

10-90-BAT replacement battery for 10-90 microphone.

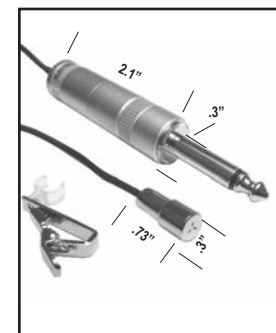

Visit Calrad on the Web at: www.calrad.com

CALRAD

10 Series - Microphones

10-12

MINIATURE ELECTRET CONDENSER MICROPHONE

This microphone is designed for all uses. ON/OFF switch enclosed on the belt clip for easy use. Designed for quality at a low cost. 15ft. cable is terminated with a 3.5 mm plug.

Specifications:

Type	Electret Condenser	Impedance	1K Ω (at 1KHz)
Frequency Response	50-18KHz	Power Supply	1.5 volt AAA battery (included)
Sensitivity	-65 dB at 1000Hz	Accessories	3.5mm to 1/4" adapter, Battery, Tie Clasp, Wind Screen
Polar Pattern	Omni-Directional	Color	Black
Power Supply Size	2.51" L x 1.84" W x .54" H	Cord to Mic Length	38"
Microphone Size25" L x .54" W		

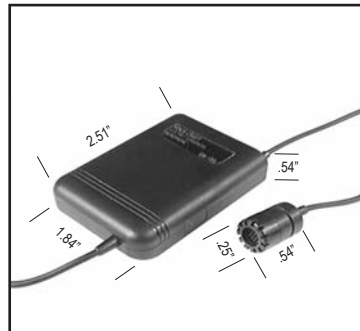

10-20

DUAL IMPEDANCE DYNAMIC MICROPHONE

Features a uni-directional element, built-in pop and noise filter and a 20 ft. cable terminated in a 1/4" phone plug with mic holder.

Specifications:

Type	Dynamic	Dual Impedance	600 Ω 50K Ω
Frequency Response	80-12KHz	Sensitivity	500 Ω -72 dB +/- 3db
Cord Length	20 feet	Sensitivity	50K Ω -54 dB at 1 KHz
Dual Impedance	600 Ω 50 K Ω		



10-22

ECONOMY DYNAMIC MICROPHONE

This uni-directional dynamic microphone has a 10 ft. cable terminated to a 1/4" phone plug. A windscreen is built into the wire mesh ball head to prevent hiss, pop, and wind noise.

Specifications:

Impedance	500 Ω	Sensitivity	-72 dB \pm 3 dB at 1 KHz
Frequency Response	80-12 KHz	Color	Black



10-3

GOOSENECK PAGING MICROPHONE

Uni-directional 18" gooseneck microphone with XLR male socket with push On/Off talk button.

Specifications:

Low-Z	600 Ω .
Sensitivity:.....	80dB \pm 3dB.
Frequency response:	60-12KHz.
Color:.....	Black.



CALRAD

10 Series - Microphones & Accessories



Front view

10-19 DESKTOP MICROPHONE BASE

Push On/Off talk switch with red L.E.D. indicator, requires 2 AAA batteries. Female XLR mic input to Male XLR output. Sturdy weighted base. Color is black.



30-590 Chrome
30-590-BK Black
 Female XLR desktop mount in black or chrome, used for quick release style gooseneck mics. Removable solder type Female XLR. Mounts with 3 screws included. Base diameter. 1.75", height 2".



10-50 MICROPHONE RETRACTABLE COIL CORD

Excellent for CB or Ham radio replacment mic cable. 3 conductor shielded cable. 5ft extended or 2ft retracted

10-37 USB PC MICROPHONE

Calrads new professional podcasting PC microphone is easy to use, simply plug-in the USB cable to your PC or laptop. Select the microphone from the list of available devices under voice recording in windows. 16 bit A/D converter for low noise and precise audio reproduction. Great for making digital voice recordings.

SPECIFICATIONS

Frequency Response: 50hz~18KHz
 Polar Pattern: Uni-directional
 Mic Element: Output Impedance 600W +/-30%
 Output Level: -65db+/-3db
 A/D Converter 16 Bit Resolution, 48KHz Sampling
 Cable: 10 ft. USB type 'A' Male to USB mini Male (Included)
 Mike Holder and 3.9" Base-Stand (Included)
 Overall Height: From base to the top of the microphone, 9.5"
 Color: Black



10-82 LOW IMPEDANCE OMNI-DIRECTIONAL MICROPHONE

Low impedance, 500 ohm mic with 5 ft. retractable cable terminated with 3 wires plus shield. Push-to-talk switching Excellent for CB radios, ham radios and general communications use.

Specifications:

Frequency Response 300Hz-5KHz
 ColorBlack



MULTI-COLOR WINDSCREEN SETS



10-67

2 1/2" high wind screens to fit 1 3/8" to 1 3/4" diameter microphones. 1 per pkg. specify color.

- 10-67-BK....Black
- 10-67-GN ..Green
- 10-67-RD.....Red
- 10-67-YL...Yellow



10-68

Windscreen for spherical head microphones 1 5/8" High to fit over 1 3/4" to 2" microphones. 1 per pkg. specify color.

- 10-68-BK.....Black
- 10-68-BU.....Blue
- 10-68-GN....Green
- 10-68-OR..Orange
- 10-68-RD.....Red
- 10-68-YL ..Yellow

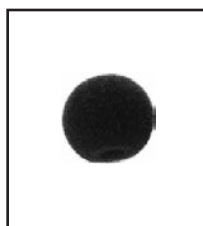

10-69

7/8" High windscreen fits 1/4" to 1/2" microphone. Designed to fit lavalier type microphones. 1 per pkg. specify color. Black, Green, Red, Yellow,

- 10-69-BK....Black
- 10-69-GN..Green
- 10-69-RD.....Red
- 10-69-YL..Yellow



10-9

2 3/4" High Screen Universal Type Fits slim models from 3/4" to 1 1/8". 1 per pkg. Color: Black.

10 Series - Isolation & Line Matching Transformers

10-76 DUAL IMPEDANCE LINE MATCHING TRANSFORMER

Comes with built-in High/Low switch. No wiring necessary. 1/4" Male mono plug with switchable input between 600Ω / 50KΩ to 600Ω XLR Female output.



10-86 DUAL IMPEDANCE LINE MATCHING TRANSFORMER

Comes with built-in High/Low switch. No wiring necessary. 1/4" Male mono plug with switchable input between 600Ω / 50KΩ to 600Ω XLR Male output with 6 inch cable.



10-77 DUAL IMPEDANCE LINE MATCHING TRANSFORMER

Comes with built-in High/Low switch. No wiring necessary. 1/4" Female mono jack with switchable input between 600Ω / 50KΩ to 600Ω right angle 1/4" Male mono plug on a 6 inch cable.



10-87 DUAL IMPEDANCE LINE MATCHING TRANSFORMER

Comes with built-in High/Low switch. No wiring necessary. 1/4" mono Female jack with switchable input between 600Ω / 50KΩ to 600Ω XLR Female output.



10-78 TELCO & MULTIMEDIA GROUND ISOLATION TRANSFORMER

Audio isolation transformer. 600Ω to 600Ω. Helps prevent ground loop problems. Used for computer and telephone applications. Male to Female mono 3.5mm connectors. Over all length 10 inches.



10-88 DUAL IMPEDANCE LINE MATCHING TRANSFORMER

Comes with High/Low switch built in. No wiring necessary. XLR Male switchable input between 600Ω / 50KΩ to 600Ω XLR Female output.



10-78-RCA RCA ANALOG & DIGITAL GROUND ISOLATION TRANSFORMER

Provides protection from ground loops. Used for standard low level analog and digital audio signals. Bandwidth up to 50KHz. 1:1 transformer. One RCA jack to one RCA plug. Overall length 10 inches. Two pieces required for stereo use.



10-89 DUAL IMPEDANCE LINE MATCHING TRANSFORMER

Comes with High/Low switch built in. No wiring necessary. 1/4" Female phone jack switchable input between 600Ω / 50KΩ to 600Ω XLR Male output.



10-79 DUAL IMPEDANCE LINE MATCHING TRANSFORMER

Comes with built in High/Low switch. No wiring necessary. 1/4" Male mono plug switchable input 600Ω / 50KΩ to 600Ω XLR Male output.



10-99 DUAL IMPEDANCE LINE MATCHING TRANSFORMER

Comes with High/Low switch built in. No wiring necessary. 1/4" Male mono plug switchable input between 600Ω / 50KΩ to 600Ω XLR Female output on a 9 inch cable.



CALRAD

10 Series - Microphone Adapter Cables

10-140-5.....5 ft.
10-140-10.....10 ft.
10-140-15.....15 ft.
 Female XLR to 1/4" mono plug.
 Black PVC jacketed cable, shielded.
 Above wired: Pin 1 & 3 - ground
 Pin 2 - hot.



10-141-5.....5 ft.
10-141-10.....10 ft.
10-141-15.....15 ft.
 Male XLR to 1/4" mono plug.
 Black PVC jacketed cable, shielded.
 Above wired: Pin 1 & 3 - ground
 Pin 2 - hot



10-142-5.....5 ft.
10-142-10.....10 ft.
10-142-15.....15 ft.
 Female XLR to RCA Male plug.
 Black PVC jacketed cable, shielded.
 Above wired: Pin 1 & 3 - ground
 Pin 2 - hot.



10-143-5.....5 ft.
10-143-10.....10 ft.
10-143-15.....15 ft.
 Male XLR to RCA Male plug.
 Black PVC jacketed cable, shielded.
 Above wired: Pin 1 & 3 - ground
 Pin 2 - hot



10-144
 Female XLR to 3.5mm mono plug, 6 ft.
10-145.....6ft.
10-145-1.....1ft.
10-145RT-1.....1ft. (right angle plug)
 Female XLR to 3.5mm stereo plug.
 Black PVC jacketed cable, shielded.
 Above wired: Pin 1 & 3 - ground / Pin 2 - hot



10-146
 Male XLR to 3.5mm mono plug, 6 ft. long.
 Black PVC jacketed cable, shielded.
 Above wired: Pin 1 & 3 - ground / Pin 2 - hot.



10-147
 Male XLR to 3.5mm stereo plug, 6 ft. long.
 Black PVC jacketed cable, shielded.
 Above wired:
 3.5mm tip to XLR pin 2
 3.5mm sleeve and ring to XLR
 Pin 1 & 3 - ground

10-148-3.....3 ft.
10-148-6.....6 ft.
10-148-10.....10 ft.
10-148-15.....15 ft.
 Female XLR to 1/4" stereo plug.
 Black PVC jacketed Cable, shielded.
 Above wired: Pin 1-ground Pin 2-tip
 Pin 3-ring.



10-149-3.....3 ft.
10-149-6.....6 ft.
10-149-10.....10 ft.
10-149-15.....15 ft.
 Male XLR to 1/4" stereo plug.
 Black PVC jacketed cable, shielded.
 Above wired: Pin 1-ground Pin 2-tip
 Pin 3-ring



10-150
 XLR "Y" cable, one Male to two Females.
 Black PVC jacketed cable, shielded.
 Above wired Pin to Pin. Cable length: 3 inches.



10-150A
 High quality 8mm "OFC" version of 10-150
 cable length: 6.5 inches.



10-151
 XLR "Y" cable, one Female to two Males.
 Black PVC jacketed cable, shielded.
 Above wired Pin to Pin. Cable length is 3 inches



10-151A
 High Quality 8mm "OFC" version of 10-151
 Cable length: 6.5 inches.



10-152
 XLR "Y" cable, two 3-pin XLR Females to
 a 3.5 mm stereo plug. 6 ft. long.
 Black PVC jacketed cable, shielded.
 Above wired Pin to Pin.
 3.5mm Male XLR Female
 Tip.....Pin 2
 Ring.....Pin 3
 Sleeve.....Pin 1



10-153-1
 Female XLR to two RCA Male plugs.
 Y cable, 1 ft. long. Uses flat style black
 PVC jacketed cable, shielded.
 Above wired: Pin 1-ground
 Pin 2-tip (hot) RCA plug
 Pin 3-tip (hot) RCA plug



10 Series - Microphone & Adapter Cables

10-154-1

One Female XLR to two RCA Female inline jacks. Y cable, 1 ft. long. Uses flat style black PVC jacketed cable, shielded.
Above wired:
Pin 1-ground
Pin 2-tip (hot) RCA jack
Pin 3-tip (hot) RCA jack



10-155-1

Male XLR to two RCA Male plugs. Y cable, 1 ft. long. Uses flat style black PVC jacketed cable, shielded.
Above wired:
Pin 1-ground
Pin 2-tip (hot) RCA plug
Pin 3-tip (hot) RCA plug



10-156-1

Male XLR to two RCA Female inline jacks. Y cable, 1ft. long. Uses flat style black PVC jacketed cable, shielded.
Above wired:
Pin 1-ground
Pin 2-tip (hot) RCA jack
Pin 3-tip (hot) RCA jack



10-157-1

3.5mm stereo right angle plug to two XLR Female inline jacks. Y cable, 1 ft. long. Uses flat style black PVC jacketed cable, shielded.
Above wired:
#1 XLR:
Pin 1 & 3-ground (sleeve)
Pin 2-tip (hot) of 3.5 mm plug.
#2 XLR:
Pin 1 & 3-ground (sleeve)
Pin 2-ring of 3.5 mm plug.



10-158-6

3.5mm stereo straight plug to two XLR Male plugs. Y cable, 6 ft. long. Uses flat style black PVC jacketed cable, shielded.
Above wired:
#1 XLR:
Pin 1 & 3-ground (sleeve)
Pin 2-tip (hot) of 3.5 mm plug.
#2 XLR:
Pin 1 & 3-ground (sleeve)
Pin 2-ring of 3.5 mm plug.



10-45 MICROPHONE CABLE

Professional Series, 3-wire balanced line with Female XLR type connector on one end, 1/4" Male mono plug on the other end. Uses shielded, black rubber jacketed cable.

10-45-20..... 20 ft.
10-45-25..... 25 ft.



10-161 MIG HIGH QUALITY 1/4" MONO MALE TO FEMALE XLR MICROPHONE CABLES

Designed for most audio applications, Calrad's new MIG (mic, instrument & guitar) cable is constructed with 95% "OFC" braided copper with 22 gauge center conductors. High Density filler surrounds the conductors thereby reducing noise and strengthening tensile range. A special non-conductive epoxy is applied to the connection, then covered with heat shrink tubing. These cables are both durable and offer superior service.

10-161-1010 ft.
10-161-2525 ft.

10-95 PROFESSIONAL MICROPHONE EXTENSION CABLES

Male to Female XLR connectors, low loss. Cable with black rubber jacket, 22 gauge 2 conductor, shielded. Custom lengths available upon request.

10-95-1 1 ft.
10-95-1.51.5 ft.
10-95-22 ft.
10-95-3 3 ft.
10-95-6 6 ft.
10-95-10 10 ft.
10-95-15 15 ft.
10-95-20 20 ft.
10-95-25 25 ft.
10-95-50 50 ft.
10-95-100100 ft.
10-95B-250 250 ft. bulk cable



10-160 MIG HIGH QUALITY XLR MALE TO FEMALE MICROPHONE CABLES

Designed for most audio applications, Calrad's new MIG (mic, instrument & guitar) cable is constructed with 95% "OFC" braided copper with 22 gauge center conductors. High Density filler surrounds the conductors thereby reducing noise and strengthening tensile range. A special non-conductive epoxy is applied to the connection, then covered with heat shrink tubing. These cables are both durable and offer superior service.

10-160-1010 ft.
10-160-1515 ft.
10-160-2525 ft.
10-160-5050 ft.
10-160-100100 ft.



10-96 PROFESSIONAL MICROPHONE EXTENSION CABLES

Female to Female XLR Cable using low-loss shielded, heavy gauge rubber jacketed cable. Color is black.

10-96-10 10 ft.
10-96-15 15 ft.
10-96-20 20 ft.
10-96-25 25 ft.



CALRAD

10 Series - Microphone Accessories

10-83 (³/₈" dia.) **2 PIN, ELECTRET CONDENSER MICROPHONE ELEMENTS**
 Miniature in size, excellent quality.
 Working voltage range from 2-10 Vdc.
 Output impedance is Low-Z.
 P.C. Mount plus Case Tab.

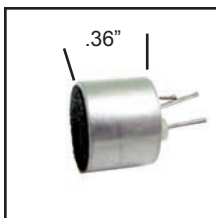

10-65 HIGH TENSION MICROPHONE CLAMP
 Used to clamp microphones to tables or fits standard mic stands ⁵/₈"-27 thread
 3 rubber pads on the inside of the jaw provides a strong protective grip. The Jaw opens to 2.5". Color: black



10-36 MICROPHONE GOOSENECKS
⁵/₈" - 27 connecting thread, ends Male to Female.
CHROME
10-36-6..... 6 inches
10-36-13..... 13 inches
10-36-19..... 19 inches



10-54 DESK MICROPHONE STAND
 Mike stand with ⁵/₈" - 27 thread. Black metal base 4" diameter, rod length is 3" from top of base.

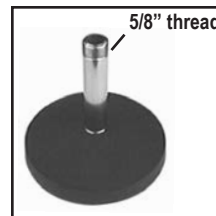

10-36-BK MICROPHONE GOOSENECKS
⁵/₈" - 27 connecting thread, ends Male to Female.
BLACK
10-36-6-BK..... 6 inches
10-36-13-BK..... 13 inches
10-36-19-BK..... 19 inches



10-55 DESK MICROPHONE STAND
 A beautiful modernistic desk stand. "U" shaped base finished in black. Supplied with a polished chrome upright tube, threaded ⁵/₈"-27 at both ends. Can be used with the other mic accessories.



10-59 MICROPHONE ATTACHMENT
 Fits any floor stand with ⁵/₈" - 27 top end thread. Accepts 3-microphone holders with ⁵/₈" - 27 connecting thread. Microphone spacing is 2 ¹/₂".
10-59A HOLDS 5 MICS
 Microphone spacing is 2 ¹/₂".



10-56 DESK MICROPHONE STAND
 Sturdy, lightweight, skidproof folding legs for portability. Accepts most microphone holders with ⁵/₈" - 27 thread. Stand spread 7". Individually packaged for display racks.



10-34 GOOSENECK BASE
 Surface mounting, die cast base, fits most gooseneck types with ⁵/₈"-27 thread. Base has Male threads. 1.75" base diameter.



10-35 GOOSENECK BASE
 Surface mounting, die cast base, fits most gooseneck types with ⁵/₈"-27 threads. Base has Female thread. 1.75" base diameter.



10 Series - Microphone & Audio Accessories

10-58 VIDEO CAMERA MICROPHONE "Hot Shoe" Attachment

For attaching microphone to video camera, movie camera, etc.
Has knurled locking knob to hold tightly.



10-60 UNIVERSAL CLAMP- TYPE MICROPHONE HOLDER

Adjustable holder with brass insert. Holds microphones $\frac{5}{8}$ "- $1\frac{3}{8}$ " in diameter.



10-97 MICROPHONE CLIP HOLDER (Tie Clip)

Fits $\frac{7}{32}$ " diameter microphones.



SLIDE-IN MICROPHONE STAND HOLDERS

Made of high impact black plastic.
Tapered design. Fits standard mike stand $\frac{5}{8}$ " x 27.

10-61A..... fits $\frac{7}{8}$ " dia. mics
10-63A..... fits 1" dia. mics
10-64A..... fits $1\frac{1}{4}$ " dia. mics



10-61A



10-63A



10-64A



10-31

10-32

10-33

10-31 MICROPHONE STAND

10-31-BK Black Version

Polished chrome plated or black finish with round black base.

10-32 MICROPHONE STAND

Polished chrome plated finish stem with $\frac{3}{8}$ " - 16 thread connector and a detachable $\frac{5}{8}$ " - 27 screw adapter for microphone holder. 3 leg base with tubular legs. Legs braced with non-skid rubber tips. Weight: 5 lbs. Height: collapsed - 35", extended - 64".

10-33 MICROPHONE STAND

Polished chrome plated finish stem with $\frac{3}{8}$ " - 16 thread connector and a detachable $\frac{5}{8}$ " - 27 screw adapter for microphone holder. Heavy duty, compact, extra high elevation adjustment. 3 leg base with foldable tubular legs. Boom sets accessories included with stand for greater adjustment and versatility. Weight: 7 lbs., Height: collapsed - 33", extended - 63".

10-115

STEREO HEADPHONE AMPLIFIER

2 inputs with individual volume controls. 200mW output at 8Ω.
Line input: 1V/47K. RCA input jacks, 3.5mm output jack. AC adapter 12Vdc, 200mA included. Black shielded metal chassis.
Size: 4.3"(W) x 1.7"(H) x 3.4"(D).



10-75

STEREO LINE MIXER

Passive stereo line mixer for camcorders and Hi-Z line level signals. 2 Hi-Z line level stereo audio inputs to 1 stereo output with RCA jacks. Individual slide style volume controls.
Black shielded metal chassis.
Size: 5"(W) x 1.7"(H) x 3.4"(D).



CALRAD

10 Series - Audio Accessories

80-575-H (HEADPHONE AMP)

80-575-M (MICROPHONE PRE-AMP)

Select from 4 standard stereo configurations. A few components are easily changed on the PC board for each preamp. The unit is available in a chassis, or completed circuit board with labeled black face plate. Includes DC power supply. Specify model and any specific specifications required for your application. Optional RCA Male to XLR Female adapter cable (Calrad part number 10-142-5).

Specifications:

Input/Output Jacks	RCA Type	Output Impedance	5K, Factory Adjusted
Power	12Vdc, 2.5mm Coax Jack	Gain	Adjustable
Input Impedance	Factory Adjusted	Frequency Response ..	20HZ - 20KHZ, +/- 3dB
Color	Black	Dimensions	4.75" (L) x 3" (W) x 1.5" (H)

80-575-L (LINE PRE-AMP)

80-575-P (PHONO PRE-AMP)



10-105 STEREO INLINE VARIABLE AUDIO ATTENUATOR

This item can be inserted into any Hi-Z audio path, provides signal attenuation from 0 db to full signal. Helps to balance audio signals from different pieces of equipment. Low profile design with easy to read volume control. RCA Male to Female cables are provided for easy interfacing with equipment, this allows the unit to be hidden or exposed. Passive design requires no external power supply.

Specifications:

Frequency Response	20hz - 20KHz	Cable lengths input, output.....	15" each
Signal Level	0dB - Full input signal level (avg. 200-400mv)	Dimensions	3.1"(W) x 1.3"(H) x 1.1"(D)
Input Connectors:	Male RCA plugs (left=white, right=red)	Color.....	Black
Output Connectors:	Female RCA jacks (left=white, right=red)		



- 10-112-BLANK.....Blank Panel / 32 Point Patch Bay
- 10-112-RCA.....with RCA Jacks / 32 Point Patch Bay
- 10-112-BNC.....with BNC Jacks / 32 Point Patch Bay
- 10-112-I-BNC.....with ground isolated BNC Jacks / 32 Point Patch Bay

Professional audio series 32 point patch bay. The 10-112 combines high quality construction and optimum insertion of either BNC, BNC isolated or RCA type connectors (specify which type when ordering). Its' steel construction makes the 10-112 ideal for rack mounting in the toughest environments. The 10-112 comes with 32 labeled patch points.

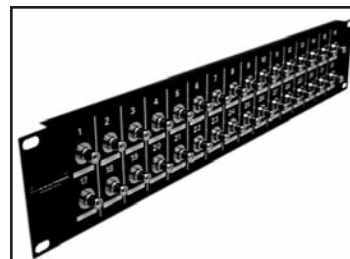

Specifications:

Dimensions.....	19"(W) x 3.5"(H) x 1.35"(D)	Color	Black
-----------------	-----------------------------	-------------	-------

10-113 MICROPHONE SPLITTER

Splits input of a single microphone to two different outputs, both input and output signals may be used to provide separate isolated feeds to both a house and monitor system, P.A. recording system or similar application where double outputs are required.

Specifications:

Input impedance	600Ω	Dimensions.....	4.75" x 3.25" x 1.75"
Output impedance.....	600Ω	Frequency Response	20-20KHZ
Color	Black		



10 Series - Audio Accessories

10-110 SPDIF* DIGITAL COAXIAL TO TOSLINK OPTICAL SIGNAL CONVERTER

10-119 TOSLINK OPTICAL TO SPDIF* DIGITAL COAXIAL SIGNAL CONVERTER

Designed to bridge the gap between home theater components with differing input/output formats. These small but important adapters convert digital signals from coax to optical or vice-versa, ensuring compatibility between TosLink/optical components and those with coax connections.

10-110 = RCA input to TosLink Female output.

10-119 = Toslink Input to RCA Female output

Size: (L) 2.8" x (W) 1.82" x (H) .88"

AC adapter included, 6Vdc 250mA.

*SPDIF=Sony Phillips Digital Interface Format.



10-117 FIBER OPTIC AMPLIFIER

This unit minimizes optical signal loss when long cable runs are used to connect optical digital audio devices. Input signal delivery

5 meters, output signal delivery 20 meters.

AC adapter included, 6Vdc 250mA.

Size: 2.8"(L) x 1.82"(W) x .88"(H). Color is light gray.



55-502-50 FT

A 50 foot fiber-optic cable for use with our 10-117 Fiber-Optic amplifier

40-DCT-2 2 WAY DIGITAL AUDIO CONVERTER ,REPEATER

Coaxial / Toslink audio converter, its compact size and convenient features provides simple solutions for interfacing digital audio gear. It accepts S/PDIF audio signal input through either Coaxial cable or Toslink cable, and passes the signal (as is) to both its coaxial and Toslink output ports. With its built-in amplification feature the 40-DCT-2 can also serve as a signal repeater and extend (double) the transferring distance. The 40-DCT-2 Cross-converts digital audio signals between "Toslink" optical and coax-electrical SPDIF formats transparently converting in either direction, and handling PCM (stereo) and bitstream (Dolby Digital, DTS) signals. Supports two-way conversion: coaxial to toslink or toslink to coaxial.



40-DCT-9 UNIVERSAL DIGITAL / ANALOG AUDIO CONVERTER

The 40-DCT-9 is a comprehensive audio converter that provides a wide variety of audio formats/interfaces for users to take advantage of. With three different types of bidirectional connectors namely optical, coaxial and L/R, the DCT-9 can convert all three signals into any preferred format. Analog audio signal input can be converted into digital output, and digital audio signal into analog output. L.E.D. Indicators show what signal type is selected. The conversion process can be done simultaneously without any signal loss or delay. Supports sampling frequencies from 16 - 100 kHz. Size: Length 3.6" x Width 3.6" x Height 1.45".



CALRAD

15 Series - Headphones

15-118

STEREO-MONAURAL HEADPHONE

High-velocity 57 mm mylar diaphragm drive units. Padded adjustable headband and earmuffs. Independent volume controls and stereo/mono switch with 1/4" phone plug.

Specifications:

Frequency Response	20-20,000 Hz	Acoustic System.....	Closed back
Impedance	32Ω	Sensitivity	102 dB at 1 mW
Maximum Power Input.....	100 mW	Cord Length.....	9 ft. with 1/4" stereo phone plug
Color.....	Black	Weight.....	300 grams



15-122A & 15-123

STEREO-MONAURAL HEADPHONES

Designed for general and educational use. Rugged construction, yet provides excellent listening comfort. Complete with padded ear cushions. Stereo/Monaural switching.

Specifications for 15-122A:

Frequency Response	30-18,000 Hz
Impedance	8Ω
Cord Length.....	10 ft. w/ stereo 1/4" phone plug
Color.....	Black

Specifications for 15-123:

Frequency Response	30-18,000 Hz
Impedance	600Ω
Cord Length.....	10 ft. w/ stereo 1/4" phone plug
Color.....	Black



15-135 or 15-135-RA

DYNAMIC STEREO-MONAURAL HEADPHONE

Expertly styled, well padded headband and earphones for snug, comfortable fit. Finely finished in black color. Stereo/Mono switching with individual volume control on each phone for perfect balance. Also available with right angle 1/4" plug (15-135-RA).

Specifications

Frequency Response	20-20,000 Hz	Cable.....	10 ft. spiral, 3-cond. with stereo 1/4" phone plug
Impedance	8Ω	Sensitivity.....	102 dB at 1 mW
Maximum Power Input.....	100 mW	Weight.....	320 grams
Color.....	Black		



15-144

PROFESSIONAL STEREO HEADPHONE WITH BOOM MICROPHONE

Excellent quality, used for broadcast monitors, switchboard, intercom and VOIP communication, headphone and microphone can be used simultaneously or independently. 1/4" plugs.

Headset Specifications:

Impedance	32Ω
Frequency Range.....	25-20,000 Hz
Max Power Input.....	100 mW
Sensitivity.....	95dB @ 1mV
Cord Length.....	3 ft.
Color.....	Black

Microphone Specifications:

Impedance.....	300Ω
Sensitivity.....	-80db @ 1KHz
Frequency Response.....	100-10 KHz
Color.....	Black



CALRAD

15 Series - Headphones

15-110 STETHOSET-TYPE MINI STEREO HEADPHONE

Stethoset type stereo headphones. Has two style ear cushions included. One is foam style and the other is soft rubber for use when conditions warrant. Supplied with a right angle 3.5 mm stereo plug and 1/4" stereo adapter.

Specifications

Frequency Response.....	20 - 20,000 Hz	Cord Length.....	4 ft.
Impedance.....	32Ω	Weight.....	25 grams
Power.....	50mW	Color.....	Black
Sensitivity.....	100dB @ 1mW	Color of Ear Pieces.....	Gray



15-143 MINI STEREO HEADPHONES

Specifications

Frequency Response.....	20-18,000 Hz	Sensitivity.....	96 dB S.P.L. at 1 KHz ± 2%
Impedance.....	32Ω ± 3%	Cord Length.....	1.2 m ± 3%
Maximum Power Input.....	100 mW	Plug.....	3.5 mm stereo
Color.....	Black		



15-145A (straight plug)

15-145A-RT (right angle plug. Includes 3.5mm to 1/4" adapter 35-550, comes with extra ear pads)

MINI STEREO HEADPHONES

Ultra lightweight, less than 2 oz, yet high performance with 27mm mini mylar drivers—excellent replacement for most portable cassette and compact disc players.

Specifications

Frequency Response.....	20-20 KHz	Sensitivity.....	100 dB 1KHz
Matching Impedance.....	4-32Ω	Cord Length.....	4 ft. w/ 3.5 mm stereo plug
Color.....	Black		



DYNAMIC EARPHONES

Earphones for most transistor radios, cassette recorders, and television private listening. Most popular types listed below. Color is ivory.

15-93-20

2.5mm sub-miniature plug with 20 ft. cord

15-95

6 ft. Low impedance—3.5 mm plug

15-96

12 ft. Low impedance—3.5 mm plug



15-106

REPLACEMENT EARPHONES

Frequency response 50Hz - 4KHz cps. Ivory colored plastic case, flex cord with miniature phone plug and closed circuit jack. Excellent for transistor radios, etc. Color is ivory. 20 ft. cord, 3.5 mm plug



15 Series - Earphones & Headphone Junction Boxes

15-131

STEREO & MONAURAL HEADPHONE JUNCTION BOX

Used with many school teaching systems and language labs, provides private listening for 8 individual persons. Individual volume control for each channel. Multiple units can be cascaded. Operates from any 8 Ω output source to 8Ω headphones. Supplied in black crackle finish, 9 ft connecting cable with standard 1/4" phone plug. Has 4 non-slip rubber feet.

Specifications:

Wattage: 50 watts maximum load

Size: 8"(L) x 6¹/₄"(W) x 3¹/₄"(H). (Individually boxed.)

Color: Black

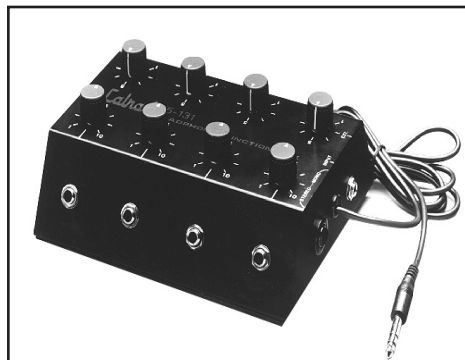

15-132

PROFESSIONAL HEADPHONE JUNCTION BOX

Provides equal signal output to 6, 1/4" headphone jacks without effecting the overall input signal. Both XLR and 1/4" inputs are provided for signal delivery. The side mounted 1/4" output jack allows connection of additional 15-132 headphone boxes in a daisy chain configuration. Designed to operate 8Ω to 600Ω headphones. Power handling capacity 50 watts max.

Size: 4³/₄"(L) x 3"(W) x 1³/₄"(H)



15-133

1X4 HEADPHONE DISTRIBUTION AMPLIFIER

headphone distribution amplifier allows low or line-level sources to drive up to 4 pairs of stereo headphones. 4 separate amplifiers drive any mix of headphones from 8Ω to 600Ω and each headphone has its own stereo volume control. The rugged steel metal case with rubber end caps makes this unit durable for any environment.

Specifications

Input Impedance: 100KW unbalanced

Output Impedance drives 8Ω, 32Ω, 600Ω

Max Input Level: +14 dBV Input

Input/Output Connectors: (5) Stereo 1/4 in. TRS phone jacks.

Max Gain: 20 dB/Channel

S/N Ratio: >90 dB

THD: <.008 IMD (SMPTE) <.008

DC Power: 12Vdc, 300ma (DC Adapter Included)

Weight: 1 lb (.45 kg)

Size: (L) 5" x (W) 3" x (H) 1.25"



20 Series - Miniature Speakers

MINIATURE SPEAKERS WITH CLEAR PLASTIC CONES

With clear plastic cones for use as emitters, beepers, etc. Impedance. 8Ω

20-174
1.57" round,
7/16" deep,
60-10KHz
frequency
response,
120 mw. Plastic
frame.

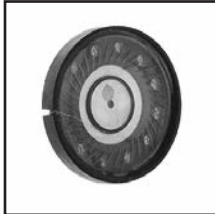

20-176
2" round,
11/16" deep,
200-4,000 Hz
frequency
response,
2 watts power.
Metal frame.



20-224A
1.1" round,
1/4" deep,
250-25KHz
frequency
response,
200 mw max
power. Plastic
frame.



20-177
2 1/2" round, 15/16"
deep,
60-8KHz frequency
response,
2 watts max. power.
Metal frame.



20-224
1" round,
.4" deep,
600-10KHz
frequency response,
.1 watts power
rated. Plastic frame.



MINIATURE PRECISION MADE SPEAKERS

Designed for miniature equipment. Amazing tone quality in a small size speaker for transistor and all sub-miniature applications. Precision made, ideally suited for pocket radio, small amplifiers and most transistorized equipment.

Paper cones. Impedance. 8Ω

20-225
1 1/2" Square,
2" mount center,
5/16" deep,
400-5KHz frequency response,
.1 watt peak power.

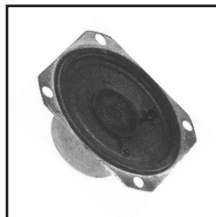

20-225R
1 1/2" Round,
5/16" deep,
400-5KHz frequency response,
.1 watt peak power.



20-226
2" Round
3/4" deep,
150-5KHz frequency response,
.5 watt peak power.



***20-228**
2 1/2" Round
13/16" deep,
150-5KHz frequency response,
.3 watt peak power.
*Special Order Only

20-227
2 1/4" Round
3/4" deep,
150-5KHz frequency response,
.4 watt peak power.

20-229
2 3/4" Round
7/8" deep,
150-5KHz frequency response,
.5 watt peak power.

20-226, 20-227
20-228, 20-229

CALRAD

20 Series - Speakers

20-301

3" 45 ohm 2 watt SPEAKER

Excellent quality, used for many types of radios and intercoms. Mylar waterproof cone.

Specifications

Impedance..... 45Ω
Power 2 watts
Size..... 3" width, 1³/₁₆" depth
Cone..... Paper



20-218

8" BACKGROUND MUSIC SPEAKER (with white ceiling grill)

Ideal for ceilings and wall mounting. Complete with 12³/₄" dia. grill and 10 watt, 25 volt line transformer (10 oz. magnet).

70 volt available upon request.

20-218VC Same as 20-218, with volume control mounted in center of grill.



20-231

3" SQUARE FRAME PRECISION MADE SPEAKER

Superior quality with high efficiency performance. Will improve tone quality of most radios or intercoms.

Specifications

Impedance..... 8Ω
Power 2 watts
Frequency Response.. 100-10 KHz
Size 3" (W), 3 1/2" (mount center) 1 1/4" (D)
Cone..... Paper
*Special Order only



20-298 BEAUTIFUL WHITE ENAMEL CEILING GRILL

8-inch speaker mounts to baffle by four nuts supplied. Mounts directly to ceiling or wall by wood screws, toggle bolts or molllys.

Size: 1⁷/₈" in diameter



20-232

3 1/2" SQUARE FRAME PRECISION MADE SPEAKER

Superior quality with high efficiency. For general replacement use. Rugged frame construction, selected cone for fine reproduction.

Specifications

Impedance..... 8Ω
Power 2 watts
Frequency Response.. 100-10KHz
Size 3 1/2" (W) X 4 5/16" (mount center) 1 3/16" (D)
*Special Order Only



20-250

WHISPER PILLOW SPEAKER

Inaudible except to the user. Low impedance type employing bone conduction principle, amazing fidelity bypassing the ear. Transmits sound to inner ear by direct contact.

Connects to the voice coil side of output transformer, 3.5 mm plug. 6 foot cord. White color.



20-233

4" UNIVERSAL REPLACEMENT SPEAKER

Heavy duty ceramic type magnet.

Specifications:

Impedance..... 8Ω
Power 2 watts
Size...4" (W) 3 1/2" (mount center) 1 7/16" (D)
Cone..... Paper



20-280

COMMUNICATION SPEAKER

Used with CB radio, ham and general purpose communications. Made of high impact plastic for durability. Comes with mounting bracket and 6 ft. cord with molded 3.5mm plug. Color: Black.

Specifications

Impedance..... 8Ω
Power..... 5 watts max
Frequency Response.... 150-4KHz



20 Series - Speakers & Paging Horns

20-211

8" PUBLIC ADDRESS & PAGING HORN

Designed for all around use, either indoors or outdoors. Fully weatherproof. Locking metal swivel is provided for ease in mounting and adjustment. Outside edge has rubber sound dampening ring.

Specifications:

Power 25 watts Bell Size 8 inches round
 Frequency Response.. 300 Hz – 7 KHz Color..... Grey
 Impedance 8Ω



20-215

OUTDOOR PAGING SPEAKER

Used in talk back systems, this weatherproof, trumpet design paging speaker gives extremely high sound level with low input power. Hams will find this speaker very useful in their mobile installations. Mounts under the hood or on the dash. Because of its sensitivity and high degree of intelligibility, it's ideal for paging systems in restaurants, office buildings, etc. Complete with adjustable mounting bracket.

Specifications:

Impedance 8Ω Size 2 5/8" x 3 3/4" x 2 3/8"
 Power..... 3 watts Color..... White



20-244

ECONOMY 5" PAGING SPEAKER & ALARM HORN

Rugged construction but lightweight. New design to compete in the low cost field. Completely weatherproof, Black plastic, 180 degree swivel bracket. Excellent for CB, security or general paging systems.

Specifications:

Impedance..... 8Ω Horn Opening 5"
 Power..... 15 watts Overall Length 5 3/8"
 Frequency Response..... 400 Hz–12 KHz ColorBlack



20-310

OUTDOOR REFLEX HORN

Rugged high impact molded plastic, high power speaker expressly designed for high power alarm drivers. 30 watt power rating. Response 350-8000 Hz. Dimensions: 4 3/4" x 8" x 9 1/4" deep. Color is white.

20-312

SIREN HORN

Same unit as 20-310 (above) except has built-in siren amplifier. Operates on 30 watts, 6–12 Vdc, our most powerful siren horn, has 3 wire hookup for yelp or steady sound. Horn Dimensions: 4 3/4" x 8" x 9 1/4" deep. Current Draw: 1.2 amps. 120 dB at 6 ft. Color is White.

*20-313

OUTDOOR HORN

Built in switching 25 + 70 volt line transformer.

Specifications:

Input Power 20 watt normal, 30 watt peak Switching 70 volt line–2W, 4W, 8W, 16W
 Frequency Response 420 Hz–15 KHz Watts 25 volt line–1W, 2W, 4W, 7.5W
 Color White

*Special Order Only

20-311

HIGH POWER PAGING ALARM HORN

Metal swivel brackets provide numerous mounting angles both vertical and horizontal for ease in mounting. Plastic Horn—11" x 6 1/2" x 8 1/2" deep.

Specifications:

Impedance 8Ω Power..... 40 watts, max.
 Color Ivory



20-310, 20-312, & 20-313



CALRAD

20 Series - In-Wall Speakers

20-330, 20-335 & 20-337

2-WAY FLUSH-MOUNT, IN-WALL SPEAKERS

Manufactured specifically for the demand of the HiFi sound enthusiast, our 3 Flush-Mount Speaker Systems are designed for easy installation in walls or ceilings where conventional box speakers are undesirable. Now you can enjoy incredible sound in any room of your home or office, without need of additional floor or shelf space. Finished in white, they can be painted to blend with any wall color.

Sold in pairs, packaged in separate boxes.

Specifications for 20-330:

Woofer.....	5 1/4" Polypropylene Cone	Wattage	35 + 35 watts, peak
Tweeter.....	9/16" Mylar Dome	Impedance.....	indicated on speaker
Crossover Frequency.....	3 KHz	Over-all Dimensions.....	7 1/2" x 11"
Frequency Response.....	50 Hz-20 KHz	Cut-out Dimensions.....	6 1/4" x 9 3/4"

Specifications for 20-335:

Woofer.....	6" Polypropylene Cone	Wattage	50 + 50 watts, peak
Tweeter.....	1" Soft Dome	Impedance.....	indicated on speaker
Crossover Frequency.....	2.5 KHz	Over-all Dimensions.....	8 5/8" x 12"
Frequency Response.....	40 Hz-20 KHz	Cut-out Dimensions.....	7 1/2" x 11"

Specifications for 20-337:

Woofer.....	8" Polypropylene Cone	Wattage	60 + 60 watts, peak
Tweeter.....	1" Soft Dome	Impedance.....	8Ω
Crossover Frequency.....	2.5 KHz	Over-all Dimensions.....	14 1/8" x 10 3/64"
Frequency Response.....	30 Hz-20 KHz	Cut-out Dimensions.....	12 3/4" x 8 9/16"

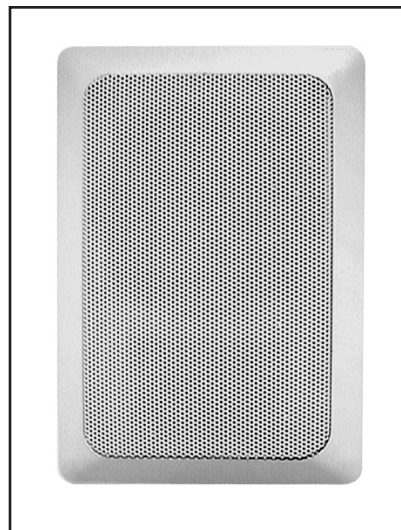

20-331

8 INCH ROUND FLUSH MOUNT CEILING SPEAKER

Features a mylar dome tweeter for outstanding performance. Easily mounts in walls and ceilings with built in retaining clips that automatically adjust to wall thickness. White finish. Attractive fine mesh grill. Wide frequency Response.

Specifications:

Woofer: 8" (207mm) Polypropylene Cone
 Tweeter: 9/16" (13mm) Mylar cone
 Depth: 3 1/2" (90mm)
 Grill width: 10 1/2" (270mm)
 Frequency Response 50Hz -20KHz
 Wattage: 60 Watt RMS
 Sensitivity: 90 dB



SPEAKER BRACKETS

20-262-BK Black

20-262-W White

2 PIECES PER BOX

Completely adjustable ABS plastic brackets are weather resistant and come complete with hardware and safety cable. Maximum load is 16 lbs.. Overall Height of 6.75". Rotation angle of 360° and a pivot angle of 40-90°. Specify black or white when ordering.

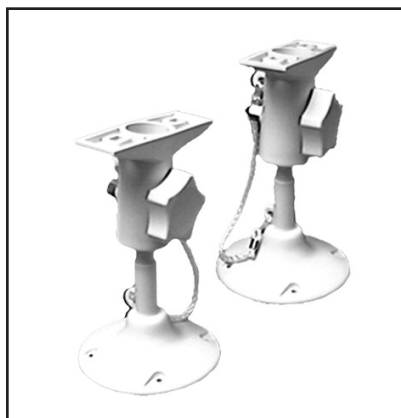

SUB-MINIATURE VOLUME CONTROLS

Linear taper, extremely smooth for quiet operation. $\frac{1}{2}$ " dia. fits into $\frac{1}{4}$ " hole. Shaft $\frac{3}{16}$ " dia. Thread length $\frac{7}{32}$ ", shaft length $\frac{9}{16}$ ", $1\frac{1}{8}$ " length overall. Supplied with mounting hardware. Specify resistance. .1watt, 20% tolerance, 300° rotation. (One per package.) Solderable terminals.

*25-290	2K Ω Linear Taper
*25-294	100K Ω Linear Taper
*25-295	250K Ω Linear Taper



VOLUME CONTROL LESS SWITCH

Replacement controls available in the eight most popular values. High quality carbon elements which have high stability under most conditions. $\frac{15}{16}$ " dia., $\frac{1}{2}$ " deep, $\frac{1}{4}$ " dia. shaft, $\frac{1}{4}$ " thread length, $\frac{5}{16}$ " shaft length, $\frac{5}{16}$ ", bushing, fits in $\frac{3}{8}$ " hole. 25-324 Long shaft 2" bushing. $\frac{1}{2}$ watt, 20% tolerance, 320° rotation. Supplied with hardware. Solderable terminals.

*25-324	Long Shaft.....	2K Ω Linear Taper	*25-328	100K Ω Linear Taper
*25-325	5K Ω Linear Taper	*25-329	250K Ω Linear Taper
*25-326	10K Ω Linear Taper	*25-330	500K Ω Audio Taper
*25-327	50K Ω Linear Taper	*25-331	1 M Ω Audio Taper



MINIATURE CONTROLS WITH SWITCH

Designed to provide extremely smooth quiet operation. Semi-log (audio) taper. Fits $\frac{5}{16}$ " hole in panels, $\frac{1}{4}$ " shaft, $1\frac{3}{16}$ " long, including threads, size $\frac{5}{8}$ " dia., $1\frac{9}{16}$ " long. Specify resistance. $\frac{1}{2}$ watt, 20% tolerance, 300° rotation. SPST switch. Switch current 125v @ 3 amps.

*25-316	5K Ω Audio Taper	*25-318	50K Ω Audio Taper
*25-317	10K Ω Audio Taper	*25-322	1 M Ω Audio Taper



MINIATURE VOLUME CONTROLS

Replacement control less switch $\frac{5}{8}$ " dia, fits $\frac{9}{32}$ " hole. Shaft $\frac{1}{4}$ " dia., $\frac{9}{16}$ " long including thread. Supplied with mounting hardware. Specify resistance. $\frac{1}{4}$ watt, 20% tolerance, 300° rotation. Solderable terminals.

*25-300	2K Ω Linear Taper	*25-305	250K Ω Linear Taper
25-300A	1K Ω Linear Taper	*25-306	500K Ω Audio Taper
25-301	5K Ω Linear Taper	*25-307	1 M Ω Audio Taper
25-302	10K Ω Linear Taper	*25-308	10K Ω Audio Taper
*25-303	50K Ω Linear Taper	*25-309	50K Ω Audio Taper
*25-304	100K Ω Linear Taper	*25-310	100K Ω Audio Taper



MINIATURE DUAL VOLUME CONTROLS

Extremely smooth action control with $1\frac{1}{16}$ " dia., fits into $\frac{9}{32}$ " hole. Extra long thread $\frac{9}{16}$ ", shaft $\frac{1}{4}$ " dia. Circuit board mounting tabs. Shaft length $\frac{1}{2}$ ". $\frac{1}{4}$ watt, 20% tolerance, 300° rotation. 1" overall length. Solderable terminals.

25-395	5K Ω Audio Taper	*25-397	50K Ω Audio Taper
25-396	10K Ω Audio Taper	*25-398	100K Ω Linear Taper (.01 watt)



MINIATURE MULTI-CLICK RATCHET CONTROLS-P.C. MOUNT 10 step

$1\frac{1}{16}$ " dia. body, $\frac{1}{4}$ " dia. shaft, $\frac{9}{16}$ " shaft length, including threads, fits into $\frac{9}{32}$ " hole. $\frac{7}{8}$ " long overall. $\frac{1}{4}$ watt, 20% tolerance, 300° rotation. Solderable terminals.

25-420	5K Ω Linear Taper (.1 watt)	*25-428	5K Ω Audio Taper
25-421	10K Ω Linear Taper (.1 watt)	*25-429	10K Ω Audio Taper
*25-422	50K Ω Linear Taper	*25-430	50K Ω Audio Taper
25-423	100K Ω Linear Taper	*25-431	100K Ω Audio Taper
25-424	250K Ω Linear Taper	*25-432	250K Ω Audio Taper
			25-433	500K Ω Audio Taper



MINIATURE MULTI-CLICK DUAL CONTROLS—40 STEP P.C. MOUNT

$1\frac{1}{16}$ " dia., $1\frac{1}{4}$ " long overall, $\frac{9}{32}$ " hole size, $\frac{1}{4}$ " dia shaft, $\frac{9}{16}$ " long shaft including threads. $\frac{1}{4}$ watt, 20% tolerance, 300° rotation. Solderable terminals.

*25-405	10K Ω Linear Taper	*25-410	10K Ω Audio Taper
*25-406	50K Ω Linear Taper	*25-411	50K Ω Audio Taper
25-407	100K Ω Linear Taper	*25-412	100K Ω Audio Taper



POTENTIOMETERS WITH AN *ASTERISK* NEXT TO THE PART NUMBER ARE BY SPECIAL ORDER ONLY, PLEASE CONTACT CALRAD FOR ORDERING REQUIREMENTS 323-465-2131

CALRAD

25 Series - Controls

SLIDE CONTROLS

Modernize your equipment with the use of Slide Controls that have rugged construction and extra smooth action. 20% tolerance. Solderable terminals.

4 7/16" Mounting Centers, 4 1 1/16" x 1/2" x 5/16" Including Terminals

25-271.....25 watt, 50KΩ Linear Taper **25-276**.....0.5 watt, 50KΩ Audio Taper

25-275.....5 watt, 10KΩ Audio Taper **25-277**.....5 watt, 100KΩ Audio Taper

3 5/32" Mounting Centers, 3 7/16" x 1/2" x 5/16" Including Terminals

25-372.....0.25 watt, 1KΩ Linear Taper **25-379**.....0.125 watt, 100KΩ Audio Taper

Dual gang slide 2 1 1/16" Mounting Centers, 2 7/8" x 3/4" x 7/32" P.C. Leads

25-39010KΩ Dual Linear Taper **25-391**25KΩ Dual Linear Taper

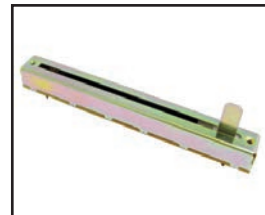

Pro Audio Use

25-341

MONO "L" PAD*

Flat frequency response, natural reproduction is obtained by adjusting for the difference in efficiency ratios.

Adjustment ±17% of the normal rated impedance. "L" pads are 8Ω impedance. Black plastic contour knob. Mounts in 3/8" hole. Bushing 3/4" long. 10-25 watts. 0-40dB attenuation. 300° rotation. Solderable terminals.



Pro Audio Use

25-342A

STEREO "L" PAD*

Single shaft control for maintaining proper output level. Providing positive equal audio power to each speaker. Has 3/8" x 32 threaded bushing 7/8" long. Impedance: 8Ω. 10-25 watts. Solderable terminals. See wiring diagram on page 22.



50 WATT HEAVY DUTY AUDIO LEVEL CONTROLS ("L" PAD)

25-352 MONAURAL* (Body Size: 2" x 2" x 1 1/16" Hole Size 3/8")

25-352-S, Same as 25-352 but with short shaft.

25-353 STEREO* (Body Size: 2" x 2" x 1 3/4" Hole Size 3/8")

Specially designed "L-Pads" to be used in high power audio or speaker systems. Made of rugged high quality materials for neat appearance and smooth operation. 1/2" long threads are provided for ease in mounting in thick cabinets. Complete with knob, hardware for mounting. Specify monaural or stereo. Impedance: 8Ω. See wiring diagram on page 22.

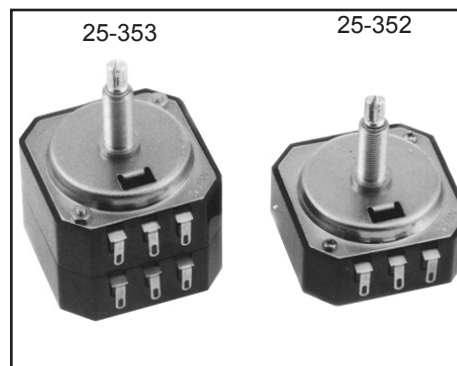

100 WATT HEAVY DUTY AUDIO ATTENUATORS ("L" PAD)

25-452 MONAURAL*

25-453 STEREO*

Controls speaker volume in a remote location. Rated up to 100 watts at 8Ω. Extra long 3/4" bushing for mounting in standard 3/8" diameter hole. Complete with front plate and knob. Heavy solderable terminals. See wiring diagram on page 22. Dimensions: 5.5"(W) X 3.14"(H) X 3.75"(D)



25 Series - Speaker Attenuators

*WIRING DIAGRAM
FOR 25-341, 25-342A,
25-352, 25-353, 25-452,
25-453

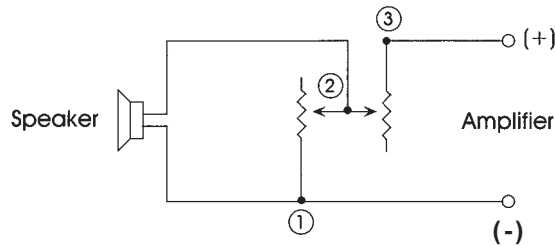

Wire 1,3 Amp, 1,2 Speaker

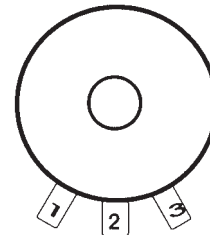

Commercial or Residential Use

25-351 10 WATT 70 VOLT AUDIO LINE ATTENUATOR - MONO

25-351A 10 WATT 8Ω AUDIO LINE ATTENUATOR - MONO

Flush mount auto transformer type. Fits into standard single gang box or ring. Excellent for use in home, paging and background music systems. Features a 10-position volume selector switch with 3dB step attenuation and a positive off position. Complete with stainless steel mounting plate, knob, with terminal block connectors. Depth 2 1/8". First 2 steps are 6dB, others are 3dB.

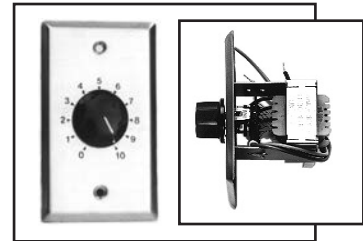

25-339 10 WATT 8Ω AUDIO LINE ATTENUATOR - STEREO

25-339A 10 WATT 70 VOLT AUDIO LINE ATTENUATOR - STEREO

Same as 25-351 (Stereo Version). 10 Watt-70 Volt. Dimensions: 2 1/2" deep x 2 1/2" high x 2" width (less shaft and knob).

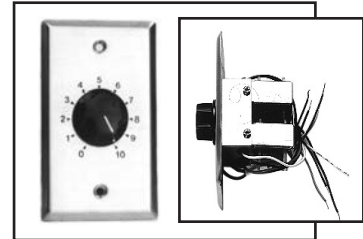

25-357 20 WATT 8Ω AUDIO LINE ATTENUATOR - STEREO

25-357A 20 WATT 70 VOLT AUDIO LINE ATTENUATOR - STEREO

25-354 25 WATT 8Ω STEREO ATTENUATOR

Single-gang box mount

25-355 40 WATT 8Ω STEREO ATTENUATOR

Click type attenuators with isolation transformers. 3 dB (10) step attenuation. Comes with terminal block connectors. White insert and knob with pointer. Accepts up to 14 awg cable. 2.3" deep. Single-gang box mount.



25-360

70 WATT 8Ω AUDIO LINE ATTENUATOR - STEREO

12 step design, each step being 3dB. The last 4 steps are 6dB each. 70 watts per channel, 150 watts peak. White insert and knob with pointer. Accepts up to 14 awg cable. Removable terminal blocks cable installation. 2.7" deep.

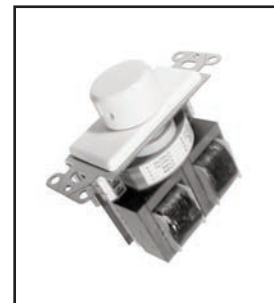

CALRAD

25 Series - Speaker Attenuators & Accessories

25-361

8 OHM STEREO MULTIPLE SPEAKER ATTENUATOR

12 step design for a total attenuation of 42dB. Matches impedance to amplifier and allows 1 to 16 attenuators to be used with one amplifier. Selectable index washer under knob for setting attenuation. Power handling 100 watts, 200 watts peak, 8Ω output. White insert and knob with pointer. Accepts up to 14 awg cable. Removeable terminal blocks, 2.7" deep.

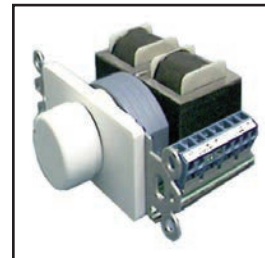

25-362

30 WATT 70 VOLT MONO ATTENUATOR

Click type 70 volt attenuator with isolation transformers. (10) step 8-3dB, 2-6dB steps for attenuation. Comes with terminal block connectors. White insert and knob with pointer. Accepts up to 14 awg cable, 2.3" deep.

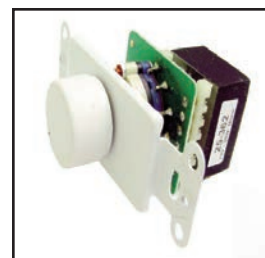

25-356

10 WATT 70 VOLT MONO ATTENUATOR

10-step attenuation for high level audio signal. Low insertion loss. Controls up to 10 watts of speaker load. Handles 70 volts RMS input. Stainless steel panel. Easy installation. Comes with terminal block connectors. White wall plate and knob with pointer.



28-145

COLORED DESIGNER STYLE INSERT COVERS

Designed to be used with the Calrad 25-360, 25-361 and 25-362 attenuators. Easy to remove designer style insert comes with matching colored knob.

28-145-AL.....Almond

28-145-BK.....Black

28-145-WH.....White

28-145-IV.....Ivory



WHITE AND IVORY KNOBS AND PLATES

For use with 25-351, 25-351A, 25-339, 25-339A, 25-357, and 25-357A. Plates have numbers 0-10. Knob is 1 5/16" in diameter and accepts 1/4" shafts.

85-565-ID Ivory Designer Style Knob

85-565-WD White Designer Style Knob

28-140-W White Wall Plate

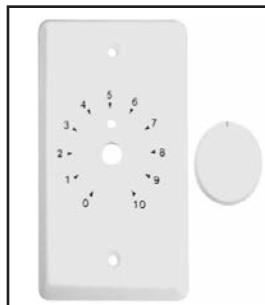

25 Series - Desktop Volume Controls & Transformers

25-345

60 WATT STEREO DESKTOP LOUDSPEAKER CONTROL CENTER

Individual volume controls for each speaker L+R. Input/Output through 4MM gold plated terminals. Can be used with CALRAD 30-605 banana plugs. Accepts 12-18 gauge cable. Sturdy metal chassis with black finish.

Dimensions: W = 5.5" X H = 3.14" X D = 3.75".



25-346

60 WATT STEREO DESKTOP LOUDSPEAKER CONTROL

Heavy duty rocker switches turns On/Off main, remote speakers. Individual volume controls for each speaker L+R. Input/Output through 4mm gold plated terminals. Can be used with CALRAD 30-605 banana plugs. Accepts 12-18 gauge cable. Sturdy metal chassis with black finish.

Dimensions: W = 8" X H = 3.5" X D = 5".



25-347

70 WATT STEREO DESKTOP ATTENUATOR

Transformer designed attenuator. Input/Output through UV approved screwless, push-type terminals accepts up to 14 AWG cable. Stereo headphone jack for private listening, shuts off speakers when headphone plug is inserted into jack. Sturdy metal chassis with light grey finish.

Dimensions: W = 7" X H = 1.25" X D = 3".



CALRAD

28 Series - Designer Style Wall Plates

28-100-P

GOLD PLATED

1 PAIR BINDING POSTS

Plastic insert plate. Standard 5 way binding posts, independently isolated terminals, with solderable leads. Insert color is white. Includes mounting hardware.

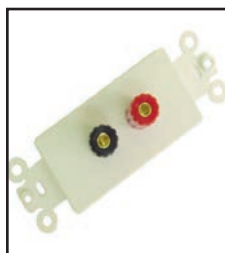

28-101-P

GOLD PLATED

2 PAIR BINDING POSTS

Plastic insert plate. Double standard 5 way binding posts, independently isolated terminals, with solderable leads. Insert color is white. With Red & black binding posts.

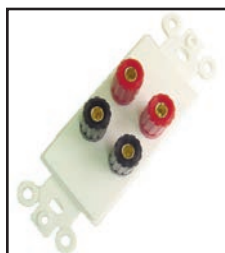

28-124

GOLD PLATED FOUR PAIR FIVE-WAY BINDING POSTS

Metal insert plate. Insert color is white. Double standard 5 way binding posts. Independently isolated terminals, with solderable leads. Red & black binding posts. Includes mounting hardware.

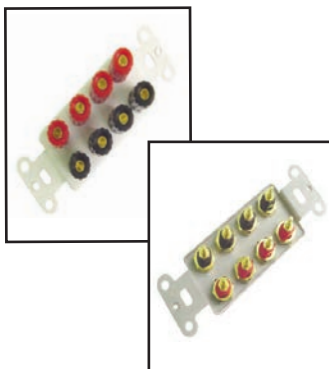

28-122

GOLD DESIGNER STYLE SPEAKER BINDING POSTS

WHITE IVORY

28-122-2 1 Pair **28-122-IV-2** 1 Pair
28-122-4 2 Pair **28-122-IV-4** 2 Pair
28-122-6 3 Pair **28-122-IV-6** 3 Pair
28-122-8 4 Pair **28-122-IV-8** 4 Pair
 Perfect for single channel outputs (L+R), A+B (L+R) or 5.1, 7.1 surround sound speaker distribution. Solderless wire termination. Works with single or dual Male banana plugs or binding post termination. Accepts up to 14 AWG cable. Available in 1, 2 or 4 channel configurations. Easy color coded speaker polarity markings (red/black) Available in white or ivory, please specify color when ordering.

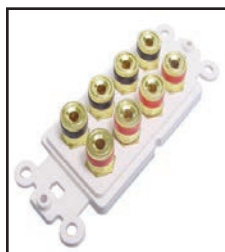

SOLDER DESIGNER STYLE INSERTS FOR AUDIO AND VIDEO WALLPLATES

Designer style inserts provide a wide variety configurations for most audio or video applications. We are now offering selected configurations with screw terminals for secure non-solderable wire connections. Connection points are labeled for easy wire identification allowing for easy installation and maintenance. We have also added both single and double HD DB15, DVI-I, HDMI feedthrus.

28-122-S-2 2 POSTS

28-122-S-4 4 POSTS NOT SHOWN

28-122-S-6 6 POSTS NOT SHOWN

28-122-S-8 8 POSTS

Gold plated binding posts. Push button connection on rear accepts 14 GA wire. Front accept single banana plugs or will screw open to accept inserted wire up to 14 GA. Color coded Red and Black on front of plate and White and Black on the rear. Power handling is 75 watts.

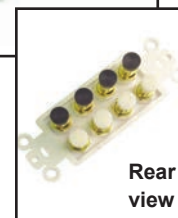

28-132

GOLD PLATED FIVE-WAY AUDIO SPLITTER

Connect 4 pairs of speakers to the terminal block, 1 pair to Designer style wall plate with gold binding posts. Removable terminal plugs for easy wiring. Power handling capacity is 75 watts. Rear terminal strips accept up to 16 awg. cable. Insert color is white. Red & black terminals.

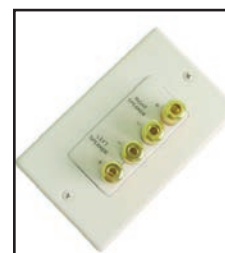

28-102-P

GOLD PLATED

1 PAIR BANANA JACKS

Plastic insert plate. Recessed banana jacks with isolated terminals and solderable leads. Insert color is white. Red/black terminals. Includes mounting hardware.

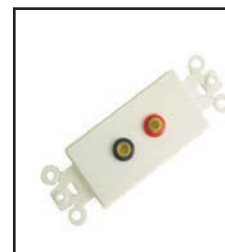

28 Series - Designer Style Wall Plates

28-103-P GOLD PLATED 2 PAIR BANANA JACKS

Plastic insert plate. Recessed banana jacks with isolated terminal, with solderable leads. Insert color is white. Red/black terminals. Includes mounting hardware.

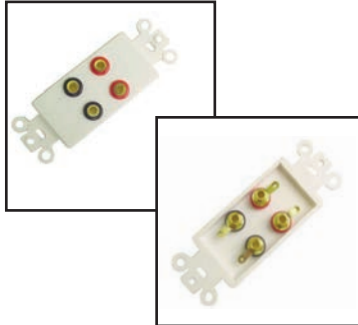

28-107-P GOLD PLATED DOUBLE RCA JACKS WITH SINGLE COAX

Plastic insert plate. Solderable red/white RCA jacks, feed-thru F connector. Insert color is white. Includes mounting hardware.

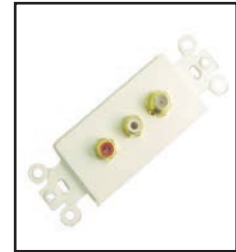

28-123 FOUR PAIR BANANA JACKS

Metal insert plate. Insert color is white. Red/black terminals. Includes mounting hardware.



28-108-P GOLD PLATED TRIPLE RCA JACKS WITH SINGLE COAX

Plastic insert plate. Solderable yellow/red/white RCA jacks, feed-thru F connector. Insert color is white. Includes mounting hardware.

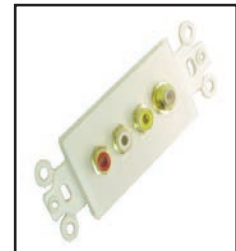

28-104-P GOLD PLATED SINGLE RCA JACK

Plastic insert plate. Standard black RCA type jack with solderable leads. Insert color is white. Includes mounting hardware.

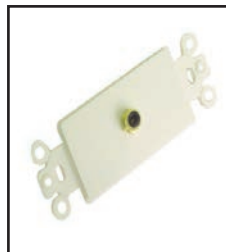

28-165 COMPONENT RGB VIDEO RCA FEED-THRU JACKS

28-165G Gold Version
Supports 480i, 480P, 7200P, 1080i resolutions. White plastic insert plate. Red, Green, Blue feed-thru Female to Female jacks with colored inserts. Nickel body connectors. Includes mounting hardware.

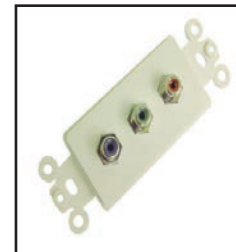

28-105-P GOLD PLATED DOUBLE RCA JACKS

Plastic insert plate. Standard red/white RCA type jacks with solderable leads. Insert color is white. Includes mounting hardware.

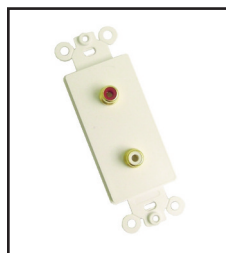

28-202D PASSIVE COMPONENT VIDEO BALUN

RJ45 or punchdown termination. Works with Cat5e UTP or Cat 6 cable. Depth 2.5", RCA connectors on front. Single gang wall Plate included.

Distance capability
480P.....300 feet
720P.....200 feet
1080i.....100 feet



28-106-P GOLD PLATED TRIPLE RCA JACKS

Plastic insert plate. Standard yellow/red/white RCA type jacks with solderable leads. Insert color is white. Includes mounting hardware.

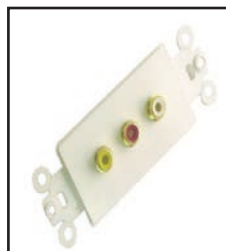

40-YW01D PASSIVE COMPONENT VIDEO BALUN WITH DIGITAL AUDIO

Supports 480i, 480P, 7200P, 1080i resolutions. 4 colored RCA jacks. Terminates to a single RJ45 jack.

Distance capability
480P.....300 feet
720P.....200 feet
1080i.....100 feet



CALRAD

28 series - Designer style Wall plates

28-125 siNg Le 50 ohm goLD pLAt eD BNC FemALe JACK
Gold Plated BNC jack in a plastic insert plate. Color is white. Solderable leads. Includes mounting hardware.

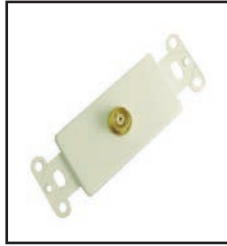

28-127 tWo RCA JACKs AND oNe FemALe BNC JACK, goLD pLAt eD
White metal insert plate. Solderable leads, includes mounting hardware.

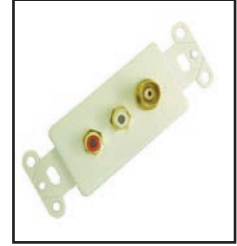

28-126 DUAL 50 ohm goLD pLAt eD BNC FemALe JACKs
Gold Plated BNC jacks in a plastic insert plate. Color is white. Solderable leads. Includes mounting hardware.



28-170 hDt V - RgB ViDeo BNC FeeD-t hRU JACKs
White plastic insert plate. True 75 ohm BNC Female to Female feed-thru jacks with eye-catching colored plastic washers for easy RGB identification. Nickel body connectors. Includes mounting hardware.

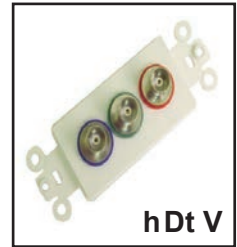

28-117-p 1/4" iNCh goLD pLAt eD st eReo JACK
Plastic insert plate. Insert color is white. Solderable leads. Includes mounting hardware.



28-151 4 pin Version, Nickel plated
28-151g 4 pin Version, gold plated
28-153 6 pin Version, Nickel plated
4 o R 6 piN miNi DiN siNg Le FeeD t hRU JACK
White plastic insert plate. Mini Din feed thru jack. Includes mounting hardware.



28-118 goLD pLAt eD XLR mALe
Plastic insert plate. Insert color is white. Solderable leads. Includes mounting hardware.



DUAL VeRsio N
28-152 4 pin Version, gold plated
Used for s-Video
28-154 6 pin Version, Nickel plated
For mouse or keyboard



28-119 goLD pLAt eD XLR FemALe
Plastic insert plate. Insert color is white. Solderable leads. Includes mounting hardware.

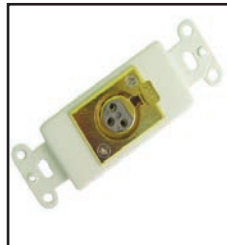

28-150g Gold
28-150 Nickel
DUAL RCA JACKs AND oNe FemALe sVhs JACK
White plastic insert plate with one SVHS video and L+R, red/white audio feed thru jacks. Comes in either Gold or Nickel plated versions. Includes mounting hardware.

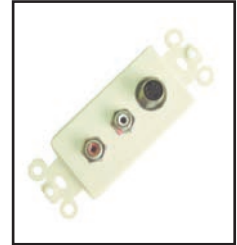

28 series - Designer style Wall plates

28-159 3.5mm Feed thru JACK

White plastic insert plate with a single 3.5mm Female to Female stereo jack nickel plated connector. Includes mounting hardware.



28-161 single high Density DB-15 Feed-thru JACK

White plastic insert with a single HD-DB-15 feed-thru jack. Available in nickel or gold plated versions. Includes mounting hardware.

28-161Nickel

28-161gGold

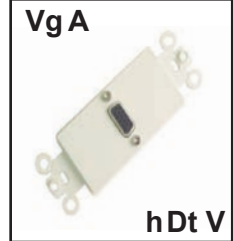

28-160 single high Density DB-15 Feed-thru AND DUAL RCA Feed-thru JACKs

White plastic insert plate. HD-DB-15 high density Female to Female jack with red/white RCA Female to Female jacks. Includes mounting hardware.

28-160Nickel

28-160gGold

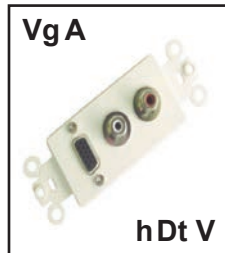

28-109-p single Coax JACK

Single gold plated feed-thru F connector on a plastic plate. Insert color is white. Includes mounting hardware.



28-161-3.5 high Density DB-15 AND 3.5mm Feed thru JACKs

White plastic insert plate. with (1) HD-DB-15 high density Female to Female jack and (1) 3.5mm Female to Female stereo jack. nickel plated connectors. Includes mounting hardware.

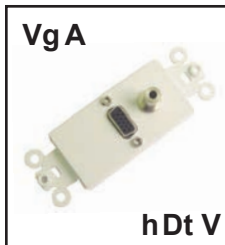

28-110-p Double Coax JACKs

Dual gold plated feed-thru F connector on a plastic plate. Insert color is white. Includes mounting hardware.



28-162 DUAL high Density DB-15

Feed-thru JACKs

White plastic insert plate. with 2 HD-DB-15 high density Female to Female jacks. Comes in either nickel or gold versions. Includes mounting hardware.

28-162Nickel

28-162gGold

28-162-m-2Metal Plate

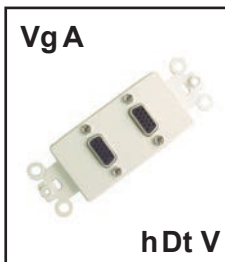

28-111-p Triple Coax JACKs

Triple gold plated feed-thru F connector on a plastic plate. Insert color is white. Includes mounting hardware.

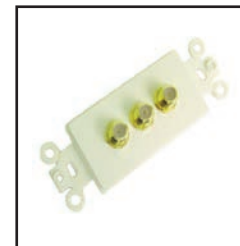

28-172 hDt V Video Wall plate with HDMI and Component Video Feed-thru JACKs

Gold plated HDMI F/F and 3 RCA F/F connectors, Color Coded: RED, GREEN, BLUE allow you to couple two HDMI cables and Component Video cables together within an in-wall installation. Perfect for HDTV and home theater needs. Color: White.

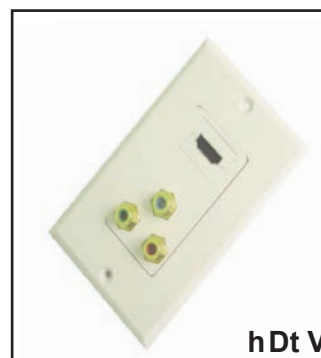

CALRAD

28 series - Designer style Wall plates

28-161-t soLDerLess VgA

White plastic insert plate with one 15 pin VGA Female to 10 position terminal block with screws. Nickel plated. Includes 2 7/16" holes. Interior depth 1 1/8". Block is marked with VGA connection information. Easy to use.

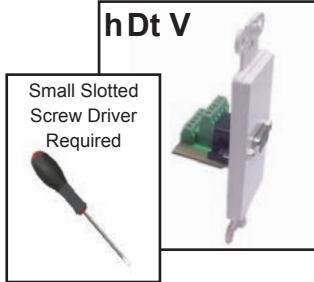

28-163p DVi-i t o DVi-i FeeD-t hRU

White plastic insert plate with one DVI-I Female to Female feedthru. Nickel plated. Includes mounting hardware Interior depth 0.4 inches.

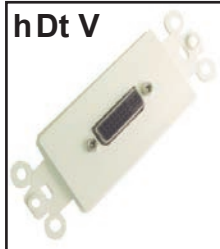

28-163 LoW pRoFiLe goLD DVi-i t o DVi-i FeeD-t hRU

White plastic insert plate with DVI Female jacks on both sides. Jacks are mounted on offset circuit board for a low profile front and back. Gold plated connectors insure excellent contact and long life. Total depth 1" front to back.

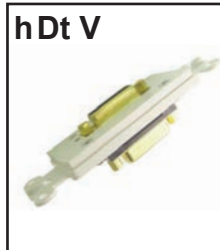

28-164-m siNg Le DVi-i FeeD t hRU 28-164-m-2 DUAL DVi-i FeeD t hRU

DVi-i FeeD-t hRU

Stainless Steel full sized wall plate with either a single or dual DVI-I Female to Female feedthru. Can only be mounted in a wall bracket style fixture and not a standard "J" box, due to extended length of rear connection (see photo). Needs depth of 3.5 inches.



28-166-Lp siNg Le VeRsioN

28-167-Lp DUAL VeRsioN

hDmi t o hDmi FeeD-t hRU

White plastic insert plate with single or dual HDMI Female to Female feed thrus. Comes with red LED signal indicator. Nickel plated. Includes mounting hardware. Color is white. LED Indicators.

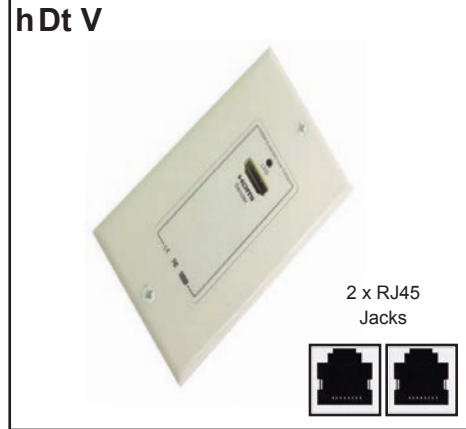

40-1074 WALL pLAt e BALUN, hDmi oVeR 2 CAT 5e/CAT 6 CABLEs

Cable Distance (CAT5e) 1080P, 100 ft., CAT6 Cable 125 ft. 1080I, 200 ft. 720P, 200 ft. 480P, 300 ft. HDMI In\Out Connectors: 19 pin Female Jacks, 2 x RJ45 Shielded Jacks each unit.

Color: White, Size: Length 4.5" x W idth 2.75" x Height 1.25".

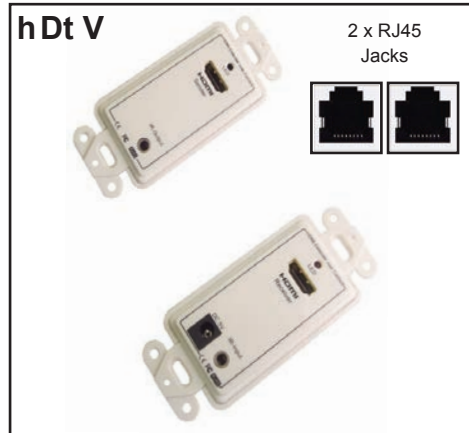

40-1075 WALL pLAt e BALUN, hDmi AND iR oVeR 2 CAT 5e/CAT 6 CABLEs

HDMI 1.3b and IR designer style wall plate balun system over two Cat5e, Cat 6 cables. Cable Distance (CAT5e) 1080P, 100 ft., CAT6 Cable 125 ft. 1080I, 200 ft. 720P, 200 ft. 480P, 300 ft. HDMI In\Out Connectors: 19 pin Female Jacks, 2 x RJ45 Shielded Jacks each unit. Color: White, External AC power adapter included. Size:

Length 4.15" x W idth 1.75" x Height 1.25".

28 series - Designer style Wall plates

28-166k
keYst oNe hDmi 1.3B
FemALe t o FemALe
iNseRt

Fits in a standard keystone cut out, 1.3b Certified Female HDMI on front and back Keystone is rotated 90 degrees to insert into any standard keystone face plate, Gold-plated Connectors. wall plate not included. Overall depth 1", Color: White

Decora plate not included

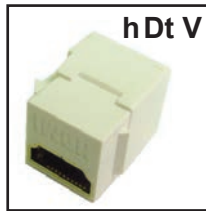

28-168-1 (1 po Rt)
28-168-2 (2 po Rt)
pLAsT iC WALL pLAt e
Wit h st RAight sNap-iN
hDmi FemALe t o FemALe
Co UpLeR

1 or 2 port wall plates, with Female/Female gold plated HDMI gender changer module so you can use standard HDMI cables. 1.3b Certified, Color: White.



28-169-1 (1 port)
28-169-2 (2 port)
pLAsT iC WALL pLAt e
Wit h 90 DegRee sNap-iN
hDmi FemALe t o FemALe
Co UpLeR

1 or 2 port wall plates, with 90 degree (Right Angle) Female/Female HDMI gender changer module so you can use standard HDMI cables inside walls without having to bend your cables at angles that could damage them. Includes a single or double HDMI insert. 1.3b Certified, Color: White.

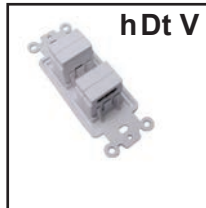

eXAmPLe 1A

These plastic inserts come with Calrad part numbers 28-168-1,-2, 28-169-1,-2 28-171-1,-2. They provide a simple solution to easily insert and remove the HDMI modules to create your own custom wall plates, Color: White.

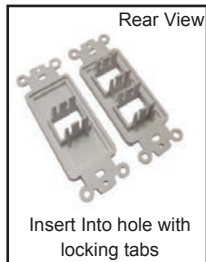

28-171-1 (1 port)
siNg Le poRt hDmi 4" pig t AiL
hDmi FemALe t o FemALe
Co UpLeR

Fits into special plastic wall plates with inner locking snap-in cut outs, included, see example 1A. 1.3b Certified, 1-7/8" depth, Color: White.



28-171-2 (2 po Rt)
DUAL poRt hDmi 4" pig t AiL
hDmi FemALe t o FemALe
Co UpLeRs

Fits into special plastic wall plates with inner locking snap-in cut outs, included, see example 1A. 1.3b Certified, 1-7/8" depth, Color: White.



40-hW01
hDmi AND iR
WALL pLAt e BALUN

HDMI 1.3 and IR wall plate balun system over two Cat5e, Cat 6 cables. Transmission Distance (CAT5e) 1080P, 100 ft., CAT6 Cable 125 ft. 1080I, 200 ft. 720P, 200 ft. 480P, 300 ft. Color: White. External AC power adapter included. Sold in pairs.



CALRAD

28 series - Designer style Wall plates

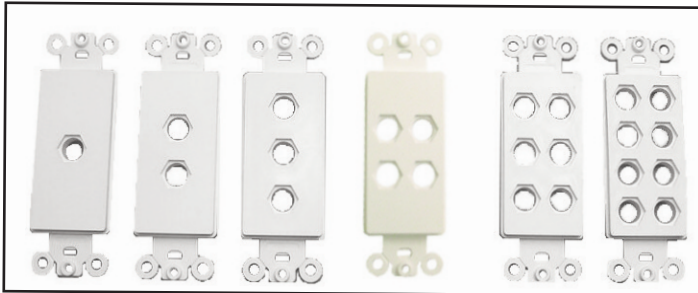

28-180

heX hoLe DeSiGNeR iNseRt s

White and Ivory plastic insert plates available in 1, 2, 3, 4, 6, and 8 hole configurations. Will accept any 3/8" audio & video connectors, RCA, RF, etc. Works with Calrad 30 and 75 Series 3/8" feed-thru connectors.

please specify hole number and color version when ordering

Hex cutout = .445", Colors: White or Ivory

iVoRY

28-180-1-iV.....1 hole
 28-180-2-iV.....2 holes
 28-180-3-iV.....3 holes
 28-180-4-iV.....4 holes
 28-180-6-iV.....6 holes
 28-180-8-iV.....8 holes

Whit e

28-180-1.....1 hole
 28-180-2.....2 holes
 28-180-3.....3 holes
 28-180-4.....4 holes
 28-180-6.....6 holes
 28-180-8.....8 holes
 28-180-hp-Bk...Black hole plug

Insert connectors for the 28-180 series are the 30-410-3/8, 30-410G-3/8, 30-424, 30-400, 30-411, 30-394, 30-710, 30-711, 30-712, 30-713, 30-714, 30-715, 75-635A, 75-520 hex connectors.

28-190

BLANK keYst oNe CUT oUt Wit h tWo 3/8" hoLes

White plastic blank insert, with 1 - blank keystone, 2 - Hex nut cutouts for .375" connectors. Hex nut size = .445"



28-114-p

BLANK iNseRt

White plastic insert plate. Insert used as a blank or can be drilled or punched to fit various jacks, connectors, etc. Includes mounting hardware.

28-114-iV Ivory Version

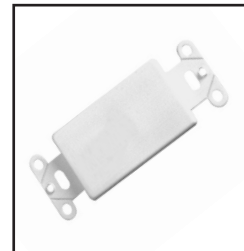

28-180-hp-Bk

3/8" blank hole plug.



siNgLe gANg pLAt es

28-112

White steel wall plate

28-113

White Plastic Wall Plate

28-113-iV

Ivory Plastic Wall Plate



DoUBLE AND t RipLe gANg WALL pLAt es

28-115-p.....double

28-115-iV Ivory Version

28-116-p.....triple

28-116-iV Ivory Version

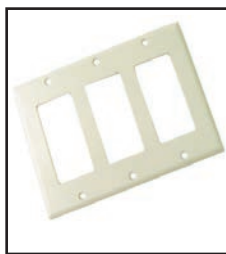

4/5/6 gANg WALL

pLAt es

Multi position wall plate allows you to do clean multiple installs of Designer plates. Attractive Ivory color

28-116p-4.....4 Position

28-116p-5.....5 position

28-116p-6.....6 Position

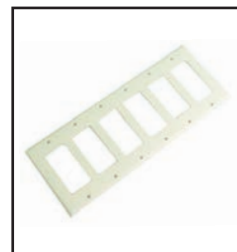

28 series - Designer style Wall plates

28-120

stereo A+B speaker Switch
White plastic insert plate. Power rating is 50 watts. Common ground switching. Includes mounting hardware.

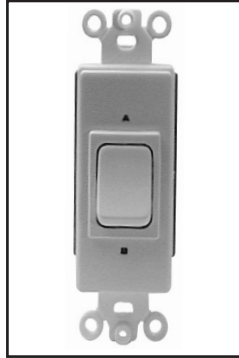

single Designer style
speaker selector inserts

28-128

headphone Jack AND speaker Switch

White plastic insert plate. Push switch and 1/4" Stereo headphone jack. 100 watts cont. / 150 watts peak. Includes mounting hardware. Input and output terminals on the back. Contains protective dropping resistor for headphone output jack.



28-129

A/B or A+B speaker Switch

White plastic insert plate. Rotary type switch. Screw-to-connect terminal blocks. 100 watts cont. / 150 watts peak. Includes mounting hardware.

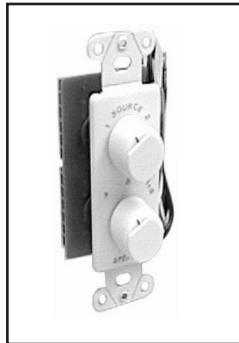

28-130

speaker selector For 2 pairs of speakers

White plastic insert plate. Push type switch. Screw-to-connect terminal blocks. 100 watts cont. / 150 watts peak. Common ground switching. Includes mounting hardware.



28-131

A-B selector For Amplifier or speaker Switching with isolated grounds

Plastic insert plate fits into single gang standard electrical junction box. Removable screw to connect terminal blocks. Accepts up to 14 awg. wire. Power handling of 55 watts per channel/max. Isolated ground terminals for amplifier protection. Easy to read terminal identification. Break before make switching.



Visit Calrad on the web at: www.calrad.com

CALRAD

28 series - Designer style Wall plates



28-145 CoLoReD DesigNeR stYLe iNseRt CoVeRs
 Designed to be used with the Calrad 25-360, 25-361 and 25-362 attenuators. Easy to remove designer style insert comes with matching colored knob.
28-145-AL.....Almond
28-145-Bk.....Black
28-145-Wh.....White
28-145-iV.....Ivory

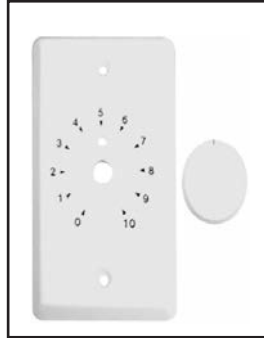

White oR iVoRY kNoBs AND pLAt es
 For use with 25-351, 25-351A, 25-339, 25-339A, 25-357, and 25-357A. Plates have numbers 0-10. Knob is 1 5/16" in diameter and accepts 1/4" shafts.
85-565-iD.....Ivory Designer Style Knob
85-565-WD.....White Designer Style Knob
28-140-W..... White Wall Plate



AlV WiRe Dist RiBUt ioN siNgLe gAng WALL pLAt e
 Angled exit wall plate allows for inwall cables to be routed downwards
 Hole Dimensions: 1.44" X.35"
28-181-iVIvory
28-181-WhWhite



28-CeDh1 siNgLe gAng CABLE Dist RiBUt ioN WALL pLAt e
 Plastic single gang hood provides a versatile method of passing multiple cables from behind the wall to equipment. Hoods may be installed in our 70-558 or 70-568 low voltage brackets and are compatible with our 28 series designer style single and multi gang wall plates. These hoods may be installed with the scoop facing in or out of the wall, to suit a variety of needs.
Dimensions:
 W 4.13" X L 1.5" X D 1.5"
 Cable Opening: W 1.2" X L 2.3"
 Color: White



28-CeDh1-Bk BLACK siNgLe gAng CABLE Dist RiBUt ioN WALL pLAt e
 Plastic single gang hood provides a versatile method of passing multiple cables from behind the wall to equipment. Hoods may be installed in our 70-558 or 70-568 low voltage brackets and are compatible with our 28 series designer style single and multi gang wall plates. These hoods may be installed with the scoop facing in or out of the wall, to suit a variety of needs.
Dimensions:
 W 4.13" X L 1.5" X D 1.5"
 Cable Opening: W 1.2" X L 2.3"
 Color: Black



28-CeR-1 siNgLe gAng sCoop stYLe CABLE Dist RiBUt ioN WALL pLAt e
 Plastic single gang hood designed for post or retrofit cable installations as well as for cables with large connectors. The lower portion of this bulk wire wall plate is removable so you can install the plate after the cables have been installed or connected. Can be used with our 70-558 or 70-568 low voltage brackets. Squared single port for maximum cable capacity. This retrofit plate is reversible so you can have the scoop inside or outside of the wall to suit a variety of needs.
Dimensions:
 2.87" W X 4.63" L X 1.56" D
 Cable Opening: W 1.56" X H .095"
 Color: White



28-CeR-2 DoUBL e gAng sCoop stYLe CABLE Dist RiBUt ioN WALL pLAt e
 Plastic dual gang hood designed for post or retrofit cable installations as well as for cables with large connectors. The lower portion of this bulk wire wall plate is removable so you can install the plate after the cables have been installed or connected. Can be used with our 70-559 or 70-569 low voltage brackets. Squared single port for maximum cable capacity. This retrofit plate is reversible so you can have the scoop inside or outside of the wall to suit a variety of needs.
Dimensions:
 4.55" W X 4.55" L X 1.75" D
 Cable Opening: W 2.975" X H 1.375"
 Color: White



28-LV1Rp siNgLe gAng CABLE Dist RiBUt ioN moUNt iNg BRACk et
 Single gang low voltage bulk cable mounting bracket designed for easy installation. Can be installed quickly using a 3.5" hole saw in 1/4" to 1 1/2" dry wall. Can also be used with our 28 series designer style wall plates.
Dimensions:
 3.8" W x 5.6"H x 2.0" D
 Total Internal Depth: 1 7/8" Measured from the back of flange
 Color: White

28-70 series - Wall mounting Brackets



**28-LV2Rp
DUAL g ANg CABLE
Dist RiBUT io N mo UNt iNg
BRACKeT**

Dual gang low voltage bulk cable mounting bracket designed for easy installation. Can be installed quickly using a 4.5" hole saw in 1/4" to 1 1/2" dry wall. Can also be used with our 28 series designer style wall plates.

Dimensions:

5 3/8" W x 5 1/4"H x 2 1/8" D

Total Internal Depth: 2"

Measured from the back of flange

Color: White

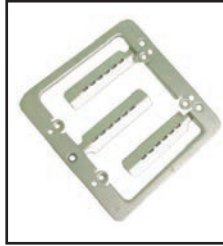

**70-558 siNg Le g ANg
70-559 DUAL g ANg**

Stainless steel EZ mount plate Comes with two mounting screws. Cut opening in the drywall and bend the tabs back inside the wall then use the supplied screws to secure the front of the plate to the tabs. (Mounting Hardware Included).



**70-553A
FLUsh mo UNt WALL
BRACKeT**

Stainless steel wall bracket with two bendable tabs for a standard single gang wall opening.

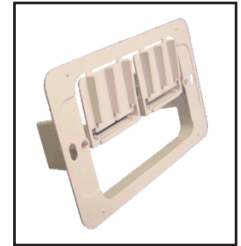

**70-556-p Single Gang
70-557-p Double Gang
FLUsh mo UNt pLAsT iC
WALL BRACKeT**

Single or Double gang flush mount bracket with adjustable locking mounting tabs



**70-568
siNg Le g ANg FLUsh
mo UNt pLAsT iC WALL
BRACKeT**

Single gang plastic flush mount bracket with rotating adjustable/locking mounting tabs, provides a large open area behind the wall plate for volume controls and other A/V products to mount in, Color is black.



**70-569
DUAL g ANg FLUsh
mo UNt pLAsT iC WALL
BRACKeT**

Double gang plastic flush mount bracket with rotating adjustable/locking mounting tabs, provides a large open area behind the wall plate for volume controls and other A/V products to mount in, Color is black.

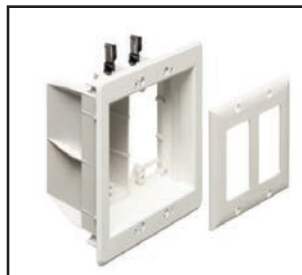

**28-t VBU505 (Whit e)
28-t VBR505 (BLACK)
ReCesseD t Wo g ANg
ComBo Bo X**

Allows you to mount LCD and plasma TVs, and other system components flush against the wall. This two-gang box is a combo box with half 110V for power and half low voltage for Class 2 wiring of satellite or cable TV, speakers, surround-sound, etc. Mounting "wings" tighten against the wall board or screwed directly to the stud to hold the box firmly in place. There's no wobble. Plugs stay inside - don't protrude past the wall! for a secure installation. Available in a white or black finish. Material paintable ABS plastic. All the necessary mounting hardware is included.



**28-LVU1W (Whit e)
28-LVU1BL (BLACK)
ReCesseD t Wo g ANg
ComBo Bo X**

The 28-LVU1W, LVU1BL series recesses low voltage box is the perfect space saver behind LED/LCD or Plasma TVs. This single gang, recessed, low voltage box allows for AV cables to come out of the wall starting from behind the sheetrock surface. The recessed feature allows connectors to be set back so flat panel TVs can be placed closer to the wall. Arlington's innovative design not only saves space but allows for all new constructions or any retrofit applications. All the necessary mounting hardware is included.

CALRAD

30 series - Audio Connectors

LoCKiNg RCA pLUgS

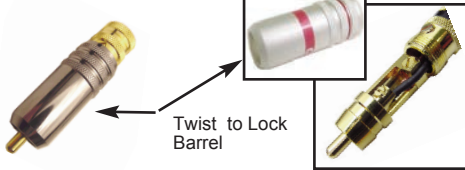

Twist to Lock Barrel

Small Slotted Screw Driver Required



30-607-Bk 30-607-RD

Locking RCA plug for up to 8 mm wire. Locking black chrome barrel comes with black or red color ID band. Teflon insulator. .35" cable opening.

30-607s-Co Lo R

Solderless locking RCA plug w/ screw terminals for up to 8 mm wire. Teflon insulator. with .35" cable opening. Barrel comes with matte silver finish **Available with black, blue, green, red, white and yellow bands.** Also available with black chrome barrel

soLDeR AND soLDeRLeSS LoCKiNg RCA pLUgS

Locking RCA Audio & Video Plugs offer secure connections for open environments where cables can be accidentally disconnected. Both are gold plated with barrel that screws down, compressing the contacts onto the jacks. Available in either solder or solderless models and both accept cable up to .35".



30-289
for 6mm cable.
.22" cable opening.

30-290
for 8mm cable
.324" cable opening
Gold plated 75 ohm RCA Audio & Video plug with black chrome barrel.

Available with the following colored ID bands. please specify when ordering

Black.....Bk
Blue.....BU
green.....gN
Red.....RD
White.....Wh
Yellow.....YL



30-291
for 2.8mm cable
.12" cable opening.

30-292
for 4mm cable
.16" cable opening.
Gold plated 75 ohm RCA Audio & Video plug with black chrome barrel.

30-289-Co Lo R

Rubber ID bands used to color code audio and video connectors. Available in black, blue, green, red, white and yellow. please specify color when ordering. Can also be used with Calrad parts: 75-533 ps, 75-534-ps series



RCA pLUgS Wit h gRoUNDiNg CABLE CLamp,

Gold plated RCA Audio & Video Plugs. When the barrel is tightened onto the body of the connector, 6 fingers secure the outer jacket of the cable to the connector.



soLDeR VeRsIoN

30-293-Co Lo R

Solder version for 6mm cable
specify color: black, blue, green, red, white and yellow



soLDeRLeSS VeRsIoN

30-293s-Co Lo R
Solderless version for 6mm cable. specify color: black, blue, green, red, white and yellow



30-298-Bk Black
30-298-RD Red
30-298-Wh White
Barrels are silver matte with red and white colored ID bands



30-298g-Bk
30-298g-RD
30-298g-Wh
All gold barrels with red, white or black painted ID colored bands



30-303-Co Lo R
Gold plated RCA Audio & Video Plug for 5-7mm diameter wire. Nickel barrel with easy grip knurling. .29" cable opening.

goLD pLAt eD soLDeRLeSS RCA pLUg FoR 8mm CABLE.

High quality Audio & Video Plugs. Teflon insulation with slotted screws for ground and tip connections.

Available with Black, Blue, green, Red, White and Yellow colored ID bands for easy identification. please specify color when ordering.



30-390 Male
30-391 Female
Shielded RCA inline Audio connectors, gold plated with strain relief .2" cable opening.



30-427 Male
30-429 Female
Shielded, nickel plated RCA-type inline Audio & Video plug, jack with cable clamp and strain relief .21" cable opening.



30-308
Professional quality RCA Audio Plug with gold pin and sleeve. nickel barrel and .24" cable opening.
Gold plated sleeve and pin.



30-307 **30-309**
pRo QUALit Y RCA pLUgS
These Male and Female pro quality Audio & Video Plugs provide high styled looks combined with superb craftsmanship and superior materials. They come with gold plated contacts and chrome barrel with finger grip knurling. The 30-307 comes with a solid center pin. Spring strain relief accepts cable sizes up to .25".

CALRAD

30 series - Audio Connectors

Technical drawings and specifications are available for these connectors. Please ask your Calrad sales representative for details.



30-387 Gold
30-387-Nk Nickel
 Heavy duty gold or nickel RCA Audio Plug for use on cable up to RG59 coax. Spring strain relief. .28" cable opening.



30-302-Co Lo R
 Gold plated RCA Audio & Video Plug with teflon insulator for 6-8mm cable. Black chrome barrel with easy grip knurling. .35" cable opening. Available in black, red, white, yellow



30-308k -s
 New Solderless Keystone & Chassis Mount RCA Jack. Easily mountable RCA jack for either 1/2" chassis mount or keystone insert. Screw terminals provide for a clean solderless backside termination. For use with 18 to 30 gauge wire. Terminals are marked for easy identification. Includes cable tie for strain relief. Colored plastic washer available for enhanced visual ID.



Small Slotted Screw Driver Required



CRimp-o N VeRsio N
30-294-Rg 59
 For RG59
30-294-Rg 6
 For RG6
30-294-8218
 For Belden Style 8218
30-294-1855A
 For Belden Style 1855A



soLDeR VeRsio N
30-299-Rg 59
 For RG-59
30-299-Rg 6
 For RG-6
30-299-8218
 For Belden Style 8218
30-299-1855A
 For Belden Style 1855A

75 Ohm RCA Video Plug in either crimp or solder assembly styles with a bandwidth up to 200Mhz. Gold plated center pin, contact pin and outer contact. Finger grip body for easy insertion and removal. Extra long crimp barrel (crimp version) for 55 lbs. or more of pull torque.



30-354-Rg 59
30-354-Rg 6
 75 ohm gold RCA Video Connector. Recessed barrel provides a low profile when inserted into a Female jack. Solder center pin at base of connector, fold shield over PVC, a 2 piece twist type compression fitting is used to secure the shield to the connector. Available for RG-59 and RG-6.



30-350 Red
30-352 White
 Gold plated RCA Audio & Video Plug with color coded band, knurled barrel and strain relief. .21" cable opening.



30-351 Red
30-353 White
 Gold plated RCA Audio & Video inline jack with color coded band, knurled barrel and strain relief. .21" cable opening.



30-389
 RCA Audio & Video Male solderless connector with screw terminals, cable clamp and rubber boot. .24" cable opening.



30-446 Red
30-447 Black
 RCA Audio Plugs with screw on plastic barrel & cable clamp. .18" cable opening.



30-448 Red
30-449 Black
 RCA Audio Jack with screw on plastic barrel & cable clamp. .18" cable opening.



30-430
 Insulated RCA Audio Plugs, built-in cable clamps. Easy slip-on plastic covers. Pkg'd 10 per pk. Two each black, blue, red, white and yellow Available in Bulk. .19" cable opening.
30-430-g N
 Green available separately.



30-426 2 Black 2 Red
30-426-Bk 2 Black
30-426-RD 2 Red
 Insulated RCA Audio pin plugs. In black and red or separately. .12" cable opening.



30-486
 Molded RCA Video termination plug, gold plated. 75 Ohms.



30-305
 L= .95" Short Version
 Right angle RCA Audio & Video plug with heavy gold plating, teflon insulator, for 8mm cable, short version.
30-306
 L=1.3" Long Version. .37" cable opening



30-250-Co Lo Rs
 Solder type R/A reduced profile RCA style plugs. Polished nickel finish. Available with black, blue, green, orange, red, white, yellow ID bands. For use with 6mm O.D. cable. Solid center conductor. Large 2 finger cable strain relief. Specify color when ordering.

CALRAD

30 series- pro Audio & home theater RCA Connectors



30-384
Right angle RCA Audio Plug. Solderless connector with cable clamp. .19" cable opening.



30-300-Co Lo R
RCA chassis mount Audio Jack. Gold plated with teflon insulator mount. Fits 5/16" hole. Bushing length .43" Available with black, green, orange, red, white and yellow inserts. Please specify color when ordering.



30-428-Co Lo R
Nickel Gold
30-428g -Co Lo R
Gold
Nickel plated RCA Audio Jack with hex nut and solder lug. Single hole mount. 1/4" hole. Bushing length .25"
Available with black, blue, green, orange, red, white and yellow inserts.



30-425-Bk Black
30-425-RD Red
RCA-type mini Audio Jack with hex nut grip, hex nut and solder lug. Single hole mount. 1/4" hole. 9mm hex base. Bushing length .27".



30-424-Co Lo R
RCA Audio Jack. Locking nut fits on front of panel. Shallow mounting depth. Mounts in 3/8" hole. Bushing length .26" Available with black, red, white and yellow inserts. Please specify color when ordering



30-366
PC Mount RCA Audio Jack. Closed Circuit. PCB footprint available upon request.



30-368-Co Lo R
PC mount Audio RCA Jack.
30-368g -Co Lo R
Gold version.
Available with black, red or white insert. please specify color when ordering.



30-367 Right angle PC mount Audio RCA Jack.
Non threaded Versions
30-367g Gold, black insert
30-367-Nk Nickel, black insert
Bushing length .1
Threaded Versions
30-367-t Nickel, black
30-367g -t -Co Lo R
Available with black, blue, green, red, white or yellow inserts.



3/8" Connectors

30-410-3/8-Co Lo R
NICKEL
30-410g -3/8-Co Lo R
GOLD
Mounts in 3/8" hole. Bushing length .39" Overall length is 1.14".

3/8" and 1/2" RCA to RCA Feed thru JACKS For AUDIO & VIDEO panels
Available in black, blue, green, orange, red, white and yellow inserts.
please specify color when ordering

1/2" Connectors



30-410-Co Lo R
NICKEL
30-410g -Co Lo R
GOLD
Mounts in 1/2" hole. Bushing length .29" Overall length 1.3"

30-288-Co Lo R
1/2" Co Lo ReD pLAsTiC WAsHeRs
Colored plastic washers for bulkhead 1/2" connectors. Comes 2 per each color when packaged for display. Also available in bulk
30-288-Co Lo R-B



Available in black, blue, green, orange, red, white and yellow



30-505 (4 pin)
30-505-6 (6 pin)
30-505-8 (8 pin)
Pro quality Mini Din connector for 5-7mm cable. Metal housing with gold pins, contacts and strain relief. .27" cable opening.



30-608
Pro quality SVHS 4-pin connector for 8mm cable. Gold pins. Black chrome barrel. .31" cable opening.



30-611
Same as 30-608 only w/ metallic silver barrel. Easy access solder cups with cross hair contact dividers for easy soldering



30-505-RA-6
6mm Cable
30-505-RA-8
8mm Cable
30-505-RA-Rg 174
RG-174 Cable
High Quality right angle gold plated mini din connector Front can pivot 180°. Cable reduction boots available for 5mm cables and smaller.

CALRAD

30 series - Connectors

Technical drawings and specifications are available for these connectors. Please ask your Calrad sales representative for details.



30-618 (4 pin)
30-618-6 (6 pin)
30-618-8 (8 pin)
 SVHS inline Female jack. Solder type connector. Accepts 5-7mm cable. Black chrome body with gold plated connector.
30-619 (4 pin)
 For use with 8mm cable.



30-3203-pin
30-3224-pin
30-3245-pin
30-3266-pin
30-3287-pin
30-3308-pin
 Shielded inline mini Male DIN plugs. Rated at 12 Vdc, 2A max. Accepts up to .20" O.D.



30-322J-4 (4 pin)
30-322J-6 (6 pin)
30-322J-8 (8 pin)
 Inline Female mini din connector. Solder type inline Female connector with strain relief. Shielded body with plastic cover.



Locking sVhs plug

30-505-Lk
 Locking 4 pin SVHS Male connector. Spring strain relief, Black. Mates with 30-507 chassis mount jack.



30-507
 4 pin Japanese
30-507-t
 4 pin Taiwanese
30-507-6
 6 pin Taiwanese
30-507-8
 8 pin Taiwanese
 4, 6, & 8 pin chassis mount mini-din jacks. Mounts in 9/16" hole. Bushing length .167".

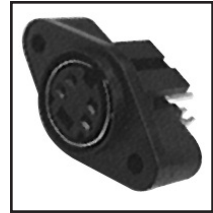

30-506
 4-pin SVHS chassis mount jack with screws for mounting.

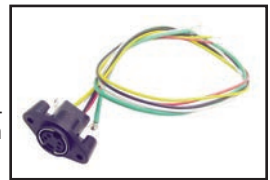

30-506-L
 4 pin SVHS chassis mount jack with 5, 10 inch colored wire leads.

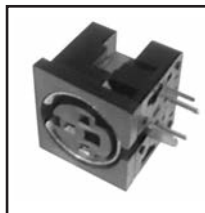

30-3213-pin
30-3255-pin
30-3276-pin
30-3297-pin
30-3318-pin
 Female Mini Din connector, printed circuit mount socket. PCB footprint available upon request.



35-498k-s
 Solderless Keystone & Chassis Mount SVHS Jack. Easily mountable SHVS jack for either 1/2" chassis mount or keystone insert. Screw terminals provide a clean, solderless, connectorless backside termination. Includes colored cable tie for strain relief. Colored plastic washer available for enhanced visual ID (Part Number 30-288-Color).



30-296-Bk
 Gold plated locking inline 3.5mm Male stereo Audio Plug with black chrome body.



30-297-Bk
 Locking inline 3.5mm Female stereo Jack. Black chrome body. O.D. .25". Mates to **30-296-Bk** locking plug.



30-318 Mono
30-319 Stereo
 Professional quality 3.5mm mono or stereo Audio Plugs with strain relief. .25" cable opening.



30-255
 3.5mm Mono
30-256
 3.5mm Stereo
30-257
 3.5mm 4 conductor

Solder type R/A reduced profile 3.5mm style plugs. For use with 6mm O.D. cable. Solid center conductor. Polished nickel finish.



30-488 Stereo
30-488g Gold
 3.5 mm stereo mini Audio Plugs with plastic handle and molded strain relief. .16" cable opening.
30-488A
 Mono Version.



30-489
 3.5 mm dia., stereo Audio Plug with plastic handle. No Strain relief. .21" cable opening.



30-416-Bk Black
30-416-RD Red
 3.5 mm mono Audio Plug with solder terminals & cable clamp. .18" cable opening.



30-490
 3.5 mm, shielded mini stereo Audio Plug, black metal finish with strain relief. Cable opening .14".



30-376 Mono
30-386 Stereo
 3.5 mm right angle stereo or mono Audio Plugs. .15" cable opening.



30-484 Stereo
30-421 Mono
 3.5 mm stereo or mono Audio Plug, strain relief spring, solder type, with metal housing. .19" cable opening.

CALRAD

30 series - Connectors

Technical drawings and specifications are available for these connectors. Please ask your Calrad sales representative for details.



30-414 Mono
30-417 Stereo
Metal 3.5 mm mono inline Female Audio Jack .16" cable opening with strain relief.



30-487 Stereo
30-487A Mono
30-487g Gold Stereo
Mini inline 3.5 mm mono or stereo Audio Jack, plastic handle w/strain relief. .19" cable opening.



30-492
Mini 3 circuit shielded stereo Audio Jack. 3.5 mm inline black metal finish and strain relief. .14" cable opening.



30-319F
Professional quality 3.5mm stereo inline Audio Jack with strain relief .26" cable opening. Mates with Calrad Male 3.5mm connector 30-319.



30-705
Inline Female 4 conductor 3.5mm Audio & Video Jack. Tip, ring 1, ring 2, sleeve. Plastic shell with strain relief. Mates to 30-700A, 30-701, and 30-702 plugs.



30-295 Nickel
30-295g Gold
3.5mm stereo Female to Female bulk head feed-thru Audio or infrared signal Jack. Mounts in 1/2" or 3/8" hole. Overall length 1.43". Available in gold or nickel.

30-295-1/2
1/2" Nickel Version.



30-295-heX
3.5mm stereo feedthru with two Female to Female jack, 3/8" hex nut for panel mounting. Threaded body.



30-701 plastic
30-701A all metal
4 conductor 3.5mm Audio & Video Plug. Tip, ring 1, ring 2, sleeve, with strain relief. Cable opening .15".



30-706
4 conductor 2.5mm right angle Audio & Video Plug. Tip, ring 1, ring 2, sleeve. Cable opening .1".



30-702
4 conductor 3.5mm right angle Audio & Video Plug. Tip, ring 1, ring 2, sleeve. Cable opening .14".



30-707
4 conductor metal 3.5mm Female to Female Ground isolated feed-thru jack Mounts in 1/2inch opening.



30-485 Stereo
30-485A Mono
2.5 mm stereo or mono Audio Plugs with strain relief and metal housing. .13" cable opening.



30-423A
2.5 mm sub-mini Audio Plug with plastic grip, 2 cond. Improved solder points. 7/16" plug length. .15" cable opening.



30-376-2.5 Mono
30-386-2.5 Stereo
2.5 mm right angle stereo or mono Audio Plugs. .15" cable opening.



30-479
2.5mm inline stereo Audio Jack with strain relief .13" cable opening. Plastic non conductive insert.



30-493A, 3.5mm
30-494A, 2.5mm
Mini or sub mini stereo Audio Jack. Panel mount. Mounts in .25 hole. Bushing length .165".



30-700A
4 conductor 3.5mm chassis mount stereo Audio & Video Jack. Tip, ring 1, ring 2, sleeve. Mounts in .28" hole.



30-712k-s
Solderless Keystone & Chassis Mount 3.5mm stereo Jack. 1/2" chassis mount or keystone insert. Screw terminals provide a clean solderless termination. 18 to 30 gauge wire.

30-712k-s-2
2.5mm stereo version

Small Slotted Screw Driver Required



3.5mm VeRsio N
30-710 2 conductor
30-711 3 conductor
30-712 4 conductor
2.5mm VeRsio N
30-713 2 conductor
30-714 3 conductor
30-715 4 conductor



Non-Conductive Housing

3.5mm or 2.5mm snap-in chassis mount Audio Jack. Nickel plated connector with black molded trim. Isolated from ground, requires no hardware, solder style terminals. Mounts in .375" hole up to .07" panel thickness.

30-493A-6 inch
3.5mm Mini stereo audio jack with 6 inches stripped and tinned leads. Shielded two conductor cable with Black shrink tube strain relief. Red and Black wire color. Mounts in 1/4 hole. .165" bushing length.



CALRAD

30 series - Connectors

Technical drawings and specifications are available for these connectors. Please ask your Calrad sales representative for details.



30-491

Mini 3 circuit stereo Audio Jack. 3.5 mm open circuit, PC-type.



30-364

PC mount 3.5mm mono miniature Audio Jack. Normally closed circuit. PCB footprint available upon request.

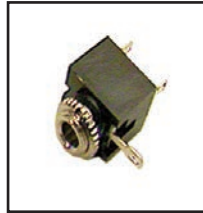

30-477

3.5mm mini stereo Audio Jack. Black PVC plastic construction, perfect for mounting in tight places. Size: .33"(L) x .35"(W) x .23"(H) with solderable leads. Bushing length .135". Mounts in a .25" hole.



30-422

3.5 mm miniature closed circuit mono Audio Jack mounts in 1/4" hole, in panels up to 1/8" thick. Nickel plated. Bushing length .17".



30-365

PC Mount 2.5 mm mono miniature circuit Audio Jack. Closed circuit. PCB footprint available upon request.



30-478

Mono 2.5 mm sub-mini closed or open circuit Audio Jack, mounts in panels up to 1/16" thick. Comes with nut and washer. Bushing length .149".



30-491t

Panel mounting 3.5mm stereo jack with screw terminals on the back. Depth 1 inch. Height 7/16 inch Width 1/2 inch.



30-621

1/4" mono solder type Audio Plug with strain relief.

30-621

Stereo version. .15" to .3" cable opening for both.



30-418 Nickel

1/4" Stereo Audio Plug with strain relief. .27" cable opening.



30-537 Stereo

1/4" Stereo or mono Audio plugs with screw terminals and spring strain relief. .25" cable opening.



30-404 Nickel

1/4" Mono Audio Plug with strain relief. .28" cable opening.



30-405 Mono

1/4" stereo or mono Audio Plug with thick walled barrel. 8mm hole for large gauge wire. .32" cable opening.



30-317 Stereo

Professional quality 1/4" mono or stereo Audio Plugs with strain relief. .25" cable opening.



30-419 Nickel

1/4" mono Audio Plug. Large barrel heavy duty type. Accepts oversize gauge wire. .43" cable opening.



30-401-Bk Black

1/4" Stereo Audio Plug with solder terminals & cable clamp. No Strain relief. .28" cable opening.



30-402-Bk Black

1/4" Mono Audio Plug w/ solder terminals & cable clamp. No strain relief. .28" cable opening.



30-408A Stereo

Flat right-angle, shielded 1/4" 3 circuit stereo or mono Audio Plugs Solder terminals. .29" cable opening.



30-409 Stereo

1/4" stereo or mono right angle Audio Plugs, black bakelite. .28" cable opening.



30-413

Slim 1/4" Stereo inline Audio Jack. Mates w/ 30-401. .3" cable opening.



30-420

Same as 30-413 but with metal housing and strain relief. .26" cable opening.



30-415-Bk Black

Slim inline 1/4" mono Audio Jack. Mates w/ 30-402 Black or red. .5" dia. x 1 1/16" long. .3" cable opening.



30-415m

Same as 30-415 with metal housing. .31" cable opening.

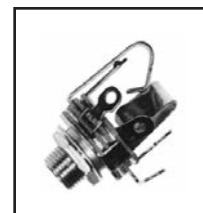

30-394A

Stereo 1/4" Audio Jack. One Closed Circuit. .355" hole size.



30-400 Stereo

3 Circuit 1/4" Open, Mono or Stereo Audio Jack. .35" x .29" bushing. .36" hole size, will work with standard .375" hole.

CALRAD

30 series - Connectors

Technical drawings and specifications are available for these connectors. Please ask your Calrad sales representative for details.



30-412A
Closed Circuit 1/4" Mono Audio Jack. .35" x .29" bushing. .36" hole size, will work with standard .375" hole.



30-395
Open Circuit.
30-396
1/4" Audio Jack. Closed Circuit 2-Conductor. 3/8" bushing. Mounts in .355" hole.



30-397
1/4" Audio Jack. Open Circuit 3-Conductor. 3/8" bushing. Mounts in .355" hole.



30-398
1/4" Audio Jack. 3-Circuit, 2 Closed. 3/8" bushing. Mounts in .355" hole.



30-399
1/4" Audio Jack. 3-Circuit, 3 Closed. 3/8" bushing. Mounts in .355" hole.



30-385
Stereo 1/4" Audio Jack. with DPDT normally closed and normally open circuits.



30-337
Coax AC/DC power plug 2.35mm O.D., .7mm I.D. .17" cable opening with strain relief.



30-336
Coaxial AC/DC power plug. 1.0mm I.D. 3.8mm O.D. .17" cable opening.



30-372
Coax power plug. 1.3mm I.D. 3.5mm O.D. 9.5mm long. .15" cable opening.
30-372-p
With strain relief. .16" cable opening.



30-635
Coax AC/DC power plug 4.75mm O.D., 1.7mm I.D., 9.2mm long, .17" cable opening.
30-632
same as 30-635 with O.D. of 4mm.



30-373
Bakelite Barrel
30-373-p
With Strain Relief. Coax power plug. 2.1 mm I.D. 5.5 mm O.D. 9.5 mm long. .15" cable opening.



30-373-14mm
2.1mm Version
30-374-14mm
2.5mm Version 14mm connector shaft, plastic body with strain relief, .15" cable opening.



30-333 2.1mm
30-334 2.5mm
coax inline Female connector. Available in 2.1mm and 2.5mm versions
O.D. = 5.5mm
.15" cable opening.



30-374
Bakelite Barrel
30-374-p
With Strain Relief. Coax power plug. 2.5 mm I.D. 5.5 mm O.D. 9.5 mm long. .15" cable opening.



30-617-2.1
30-617-2.5
Locking DC power coax plug 5.5 O.D., 9.5mm long. Insert into **30-616** jack and twist clockwise to lock. .14" cable opening.



30-623-2.1
30-623-2.5
Locking DC power coax plug. Mates with **30-624** jack. Threaded locking style. Available in 2.1mm or 2.5mm I.D. .18" cable opening.



30-375
DC coax power plug. 3mm I.D., 6.3mm O.D., 9.5mm long. With strain relief. .20" cable opening.



30-720-2.1
2.1mm version
30-720-2.5
2.5mm version
Chassis mount snap-in coax power jack. Nickel plated connector with black molded trim. Mounts in .375" hole, up to .07" panel thickness



30-624-2.1
30-624-2.5
Chassis mount locking DC power coax jack. Mates with **30-623** plug. Mounts in panels up to .07".



30-616-2.1
30-616-2.5
Locking DC power coax jack with N/C switch on sleeve side of the connector. Insert **30-617** plug and twist clockwise to lock.



30-371
Coax power jack, standard chassis mount, 2.1mm pin. Switched circuit. 17mm mount center.



30-370-2.1
2.1 mm pin,
30-370-2.5
2.5 mm pin,
PC mount coax power jack, switched circuit.



30-314
2.1mm I.D. X 5.5mm O.D.
30-315
2.5mm I.D. X 5.5mm O.D.
Chassis mount coax power jack. Plastic housing. Mounts in 1/2" dia. hole. N/C switch.



30-730
2.1mm solderless inline DC Coax power plug.
30-731
2.1mm solderless inline DC Coax power jack.

CALRAD

30 series - Connectors



30-310 2.1mm
30-311 2.5mm.
Chassis mount coax power jack. Insulated housing mounts in $\frac{5}{16}$ " hole. N/C switch. 5.5mm O.D.



30-355
Right angle coax power plug. .3mm I.D., 3.5mm O.D. with solder terminals. .22" x .12" cable opening.



30-356
Right angle coax power plug. 2.1mm I.D., 5.5mm O.D. with solder terminals. .22" x .12" cable opening.



30-357
Right angle coax power plug. 2.5mm I.D., 5.5mm O.D. with solder terminals. .22" x .12" cable opening.



30-377 Japan
30-377-t Taiwan
2.1mm I.D. 5.5mm O.D. chassis mount coax power jack. Mounts $\frac{7}{16}$ " dia. hole in panels up to $\frac{3}{16}$ " thick.



30-378 Japan
30-378-t Taiwan
2.5mm I.D. 5.5mm O.D. chassis mount coax power jack. For $\frac{7}{16}$ " dia. hole in panels up to $\frac{3}{16}$ " thick.



30-379
3.0mm I.D. 6.3mm O.D. chassis mount coax power jack. For $\frac{7}{16}$ " dia. hole in panels up to $\frac{3}{16}$ " thick.



30-340
Coax power plug converter. 1.3 mm plug to 2.1 mm jack.
30-341
2.5 mm jack version



30-343
Coax power plug converter. 2.5mm plug to 2.1 mm jack
30-344
2.5 mm jack version



30-348
Power plug converter 3.5mm plug to 2.1mm jack.



30-346
Coax power plug converter. 3.5mm plug to 2.1mm jack
30-347
2.5 mm jack version



3.5 mm mono mini-jack to DC power plug.
30-360
1.3mm coax plug I.D.
30-361
2.1mm coax plug I.D.
30-362
2.5mm coax plug I.D.



30-349
Power plug converter 3.5mm plug to 2.5mm jack.



30-363
3.5 mm mini-jack to DC power plug. 3.0 mm coax plug I.D.



30-721
Sony DC power plug with plastic strain relief. 6mm O.D. Center pin 1.3mm 1.97 overall length. accepts .17" cable O.D.



30-602-Bk Black
30-602-RD Red
Banana plug, solderless with gold plating, screw adjustment with black or red band. .15" cable opening.



30-605-Bk Black
30-605-RD Red
Solder type banana plug for large cable. Gold plated with black or red bands. Up to 8 awg wire. .25" cable opening.



30-603
Locking banana plug, can be locked down in jack, solderless, gold plated. .34" cable opening.



30-442 Black
30-443 Red
Insulated banana plug, 1" molded bakelite handle, .2" cable opening.



30-442g Black
30-443g Red
Gold versions of 30-442 and 30-443. .2" cable opening.



30-600-Bk Black
30-600-RD Red
Banana plug, gold plated solderless with Female banana tap. Black or red. .22" cable opening.



30-600-RB-Bk
30-600-RB-RD
Gold plated with rubber body. Has 2 set screws to hold cable. Fits standard banana jack.



30-604-Bk Black
30-604-RD Red
Dual gold banana plugs. For up to 8 gauge wire. .15" cable opening. 0.75" centers.



30-604-Ct-Bk
30-604-Ct-RD
Dual gold banana plugs with flexible body. For up to 8 gauge wire. .15" cable opening. 0.75" centers.

CALRAD

30 series - Connectors

Technical drawings and specifications are available for these connectors. Please ask your Calrad sales representative for details.



30-440 Red
30-441 Black
Dual banana plug, gold plated. .24" cable opening. 0.75" centers.



30-440-Nk Red
30-441-Nk Black
Dual banana plug, nickel plated. .24" cable opening. 0.75" centers.



30-444 Black
30-445 Red
Insulated banana jack. Supplied with soldering lug and nuts.



30-601 1 Red, 1 Black
30-601-Bk 1 Black
30-601-RD 1 Red
Banana/Binding post
Solderless speaker termination on each end. Accepts banana style connectors or raw speaker cable up to 14AWG. Mounts in 3/8" hole.



30-601s-Bk Black
30-601s-RD Red
Gold plated binding post with push button on one end and banana jack on the other end. threaded barrel top screws off to accept 14 Ga wire.



30-615-Bk Black
30-615-RD Red
Spade terminal, heavy duty gold plated, screw type adjustment with black or red band. .25" cable opening.



30-613-Bk Black
30-613-RD Red
30-613 Red&Black
Spade terminal, gold plated crimp on connector, with P.V.C. cover, black or red. .15" to .3" cable opening.



30-609-RD Red
30-609-Wh White
Speaker terminals with solder/solderless speaker pin. White or red color band. Accepts 8-18 awg. cable. Gold plated with black chrome finish.



30-614-Bk Black
30-614-RD Red
solderless gold speaker pins
Notched pin design prevents accidental push pin removal. Slotted or hex set screw. Accepts 10-18 Awg. Cable.



30-606-Bk Black
30-606-RD Red
Solderless speaker pin plug. Accepts up to 8 awg wire. Gold plated with red or black ID band options.



30-610-RB 1 Red, 1 Black
30-610-RBBk 2 Black
30-610-RBRD 2 Red
Rubber Speaker pin plug, gold plated with P.V.C. cover, crimp style.



30-612
Gold Speaker Terminals with hex set-screw. Pack of 4 with Hex wrench. Accepts up to 10 Awg cable.



90-799 Black
90-800 Red
5-way binding posts. Plastic insulation. Has .1875" keyed threaded mounting shaft. Mounts in panels up to .25" thick.



30-438
BNC Female to dual standard banana plugs. 0.75" centers.



30-439
BNC Male to dual binding posts for wire or standard banana plugs. 0.75" centers.

30-460
BNC Male to dual standard banana plugs. 0.75" centers.

30-461
BNC Female to dual binding posts for wire or standard banana plugs. 0.75" centers.



30-369
Right angle, 2-pin Male speaker plug. .23" x .13" cable opening.



30-392
2-pin inline Male speaker plug. .23" x .11" cable opening.
30-393
2-pin inline Female speaker plug. .26" x .17" cable opening.



30-382
In-line solderless Motorola type plug. .26" cable opening.



30-381
Antenna-type plug. To fit Calrad 30-380.



30-383
Motorola type antenna in-line twist on jack, no soldering. .3" cable opening.



30-380
Chassis mount antenna jack. Female receptacle. .4" hole size.

CALRAD

30 series - Connectors

Technical drawings and specifications are available for these connectors. Please ask your Calrad sales representative for details.



- 30-436** 5-pin inline 180°
- 30-499** 6-pin inline 240°
- 30-495** 7-pin inline 270°
- 30-497** 8-pin inline 270° "U" pattern
- 30-503** 8-pin inline 360° circular pattern



- 30-433** 5-pin inline 180°
- 30-500** 6-pin inline 240°
- 30-496** 7-pin inline 270°
- 30-498** 8-pin inline 270° "U" pattern
- 30-504** 8-pin inline 360° circular pattern



- 30-502**
5-pin (180°) version.
.18" cable opening
for both with plastic
strain relief.



- 30-509**
6-pin (240°) version.



- 30-543**
6-pin (240°) PC
chassis mount DIN
jack.

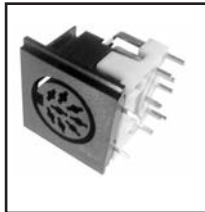

- 30-546**
8-pin (360°) circular
pattern PC chassis
mount DIN jack.



- 30-457**
4-prong Male
interlocking inline DIN
connector.
- 30-458**
5-prong version. .27"
cable opening for
both.



- 30-482** 4-pin
30-483 5-pin
Interlocking DIN-type
chassis jacks.
Accepts locking ring-
type DIN plugs Calrad
30-457 4-pin & 30-458
(5-pin) plugs.



- 30-451**
3 conductor
inline jack. .25" cable
opening.
- 30-451-m**
3 conductor
Male plug.



- 30-452**
3 conductor Male
chassis plug.
.62" hole size.



- 30-453**
4 conductor
inline jack. .25"
cable opening.
- 30-453-m**
4 conductor
inline Male plug.



- 30-454**
4 conductor Male
chassis plug.
.62" hole size.



- 30-518**
5-pin microphone
inline jack. .25"
cable opening.
- 30-518-m**
5 conductor inline
Male plug.



- 30-519**
5-pin chassis
mount Male
microphone plug.
.62" hole size.



- 30-455**
6 conductor inline
jack. .25" cable
opening.
- 30-455-m**
6 conductor inline
Male version.



- 30-456**
6 conductor Male
chassis plug.
.62" hole size.



- 30-510**
7 conductor inline
jack. .25" cable
opening.
- 30-510-m**
7 conductor inline
Male plug.



- 30-511**
7-pin Male
chassis plug.
.62" hole size.



- 30-512**
8-pin inline jack.
.25" cable
opening.
- 30-512-m**
8 conductor inline
Male plug.



- 30-513**
8-pin Male
chassis plug.
.62" hole size.



- 30-467**
PL259 Coax
chassis connector
(box-type).



- 30-468**
PL259 Coax
chassis connector
(bullet-type).
5/8" hole size.

CALRAD

30 series - Connectors



30-475

Coax adaptor plug. Adapts PL 259 type to 3.5 mm plug.



30-469

Coax universal jack adaptor. Adapts PL 259 to Motorola-type auto antenna plug or RCA-type phone plug.



30-470

Coax right angle adapter SO-239 to PL-259.



30-471

Coax "T" connector adapts 2 Females to one Male.



30-472

Coax double Female connector.



30-473

Coax cable adaptor for RG58U.

30-474

Coax cable adaptor for RG59U.



30-465

Coax cable connector plug. PL-259



30-434

Mic connector. Bright chrome plated. Knurled collar. .21" cable opening.



30-520-Bk
30-520-sL

XLR 3-pin Male in line plug. .25" cable opening.



30-521-Bk
30-521-sL

XLR 3-pin Female in line plug. .25" cable opening.



30-528-Bk
30-528-sL

XLR 3-pin Female plug, twist-on strain relief. .15" to .3" cable opening. Internal compression style cable strain relief.



30-529-Bk
30-529-sL

XLR 3-pin Male plug, twist-on strain relief. .15" to .3" cable opening. Internal compression style cable strain relief.



30-534

30-534 Silver
30-534-Bk Black
4-pin XLR inline Male plug in silver or black.

30-535 Silver
4-pin XLR inline Female jack in silver. .25" cable opening



30-630-sL-3 3 pin
30-630-sL-4 4 pin
30-630-sL-5 5 pin
Silver inline Male XLR plug. .15" to .3" cable opening.

Internal compression style cable strain relief.



30-631-sL-3 3 pin
30-631-sL-4 4 pin
30-631-sL-5 5 pin
Silver inline Male XLR plug. .15" to .3" cable opening. Internal compression style cable strain relief.

Internal compression style cable strain relief.



30-630-Bk-3 3 pin
30-630-Bk-4 4 pin
30-630-Bk-5 5 pin
Black inline Male XLR plug. .15" to .3" cable opening. Internal compression style cable strain relief.

Internal compression style cable strain relief.



30-631-Bk-3 3 pin
30-631-Bk-4 4 pin
30-631-Bk-5 5 pin
Black inline Male XLR plug. .15" to .3" cable opening. Internal compression style cable strain relief.

Internal compression style cable strain relief.



30-539

30-539 Silver
30-539-Bk Black
5-pin XLR inline Male plug in silver or black.

30-540-Bk Black
30-540-sL Silver
5-pin XLR inline Female jack in silver or black. .25" cable opening.

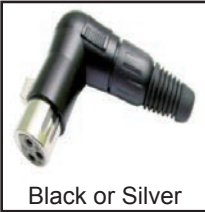

Black or Silver

30-526-Bk
30-526-sL

XLR 3-pin Female right angle plug. .17" cable opening.



Black or Silver

30-527-Bk
30-527-sL

XLR 3-pin Male right angle plug. .17" cable opening.



Black or Silver

30-522-Bk
30-522-sL

XLR 3-pin Male chassis plug. .75" hole size.



Black or Silver

30-523-Bk
30-523-sL

XLR 3-pin Female chassis jack. 15/16" hole size.



30-515

Plastic XLR 3-pin Male chassis plug. .76" hole size.



30-516

Plastic XLR 3-pin Female chassis jack. .86" hole size.

CALRAD

30 series - Connectors



30-517

Isolated plastic Female XLR with protective cover. 3-pin Female XLR mounts in $15/16$ " hole and requires a special cut out in order to mount.



30-522-sL-4 4 Pin
30-522-sL-5 5 Pin

4 or 5 pin Silver Male XLR chassis plug mounts in $.75$ " hole size.



30-523-sL-4

4 pin Silver

30-523-Bk-4

4 Pin Black

30-523-sL-5

5 pin Silver

4 or 5 pin Female XLR chassis jack mounts in $15/16$ " hole size.



on/off switch

30-638

3-Pin XLR inline Female with labeled on/off switch. Shorts pins 2 & 3 to mute signal voltage with plastic noiseless switch. Gold plated contacts.



30-514-Bk

$1/2$ " plastic XLR housing. Accepts all Calrad $1/2$ " 'D' cut chassis mount connectors.



30-590 Chrome

Black Female XLR desktop mount in, used for quick release style gooseneck mics. Removable solder type Female XLR. Mounts with 3 screws included. Base dia. 1.75 ", height 2 ".



30-524

XLR 3 pin Male to Male coupler.



30-525

XLR 3 pin Female to Female coupler.

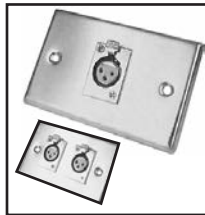

30-595

Single XLR Female jack on a steel plate.

30-596

Dual XLR Female jacks on a steel plate.



30-622-CoLoR

Colored strain reliefs for 30-620 and 30-621. Specify color when ordering. Available in black, blue, green, orange, red and yellow.



MINI XLR FEMALE

30-641-3 3 pin

30-641-4 4 pin

30-641-5 5 pin

30-641-6 6 pin

Inline Female MINI XLR jack. Also available with short boot. Cable opening $.13$ "- $.17$ "



MINI XLR FEMALE

30-641m-3 3 pin

30-641m-4 4 pin

30-641m-5 5 pin

30-641m-6 6 pin

Metal inline Female MINI XLR jack. Also available with short boot. Cable opening $.13$ "- $.17$ ".



MINI XLR MALE

30-640-3 3 pin

30-640-4 4 pin

30-640-5 5 pin

30-640-6 6 pin

In line Male MINI XLR plug. Also available with short boot. Cable opening $.17$ ".



Mini XLR Female

30-643-3 3 pin

30-643-4 4 pin

30-643-5 5 pin

30-643-6 6 pin

Chassis mount MINI Female XLR. Mounts in 15.20 mm, $.60$ hole. Nickel plated body.



Mini XLR Male

30-642-3 3 pin

30-642-4 4 pin

30-642-5 5 pin

30-642-6 6 pin

Chassis mount MINI XLR Male. Mounts in $.43$ " "D" hole. Nickel plated body.

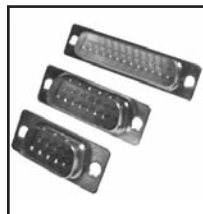

30-550 9-way

30-551 15-way

30-552 25-way

"D" solder type connector plugs



30-560 9-way

30-561 15-way

30-562 25-way

"D" solder type connector sockets.



30-553m (Nickel)

30-553m-g (Gold)

DB9, DB15HD metal housing for 10-11mm cable, with hardware. 2-piece construction, for use with DB9, DB15 type connectors.



30-554 (Male)

30-555 (Female)

Solder type DB-9, 9 pin Male or Female with metal hood and hardware. Accepts cable up to 11mm, $.433$ ".



30-556 (Male)

30-557 (Female)

Solder type HD-15, 15 pin Male or Female with metal hood and hardware. Accepts cable up to 11mm, $.433$ ".

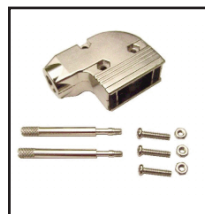

30-553m-RA

Right angle version of 30-553M. for 10-11mm cable

30-553m-RA-g

Gold plated right angle hood and hardware.



Video

30-551-hD

DB-15 high density Male plug used for computer monitor applications, graphic workstations. Numbered pins. Gold plated terminals.

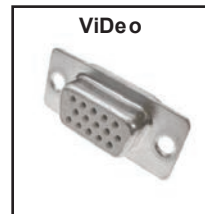

Video

30-561-hD

DB-15 high density Female jack used for computer monitor applications, graphic workstations. Numbered pins. Gold plated terminals.



Dat A

30-580

9-pin "D" connector plug to 9-pin "D" connector plug mini version.

CALRAD

30 Series -Connectors



DAt A

30-582
DB9 Female to DB 9 Female gender changer mini version.
30-582-mF
DB9 Male to DB 9 Female gender change

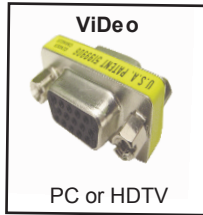

ViDeo

30-587 Nickel
30-587g Gold
15-pin Female to Female gender changer. High density "D" connector sockets for inline or panel mounting.
30-587mF
Male to Female



ViDeo

30-588
30-588g g old
15-pin Male to Male gender changer. High density "D" connector plugs for inline or panel mounting.



30-584-m
15 pin gender changer. Male-Male.



30-584-F
15 pin gender changer. Female-Female.



30-575
25-way "D" connector plug to 25-way "D" connector plug mini version.



30-577
25-way "D" connector socket to 25-way "D" connector socket mini version.



30-579
25-pin Female socket to 25-pin Female socket modem adapter.



30-585
25-pin Male plug to 9-pin "D" Female socket.



30-586
25-pin Female socket to 9-pin Male plug.



30-581
Male 9-pin "D" connector plug to 9-pin "D" connector plug.
30-583
Female 9-pin "D" connector socket to 9-pin "D" connector socket.



30-576
25-way "D" Male plug to 25-way "D" Male plug.
30-578
Female to Female



Does Not Come pRe-WiReD

30-592-6.... RJ12
30-592-8.....RJ45
30-592-8-Bk
30-592-8m
30-592-8m-Bk
RJ45 Female DB-9, D-Sub to either RJ-12 or RJ-45 jacks. grey or black plastic hood with long thumb screws. 30-592-8M has a metal hood.



30-594 10 position
30-593 6 position
VGA to MAC adapter, 10 position or 6 position Dip Switch For connecting Apple DB15 pin to HDDB 15 pin. Supports Apple standard display modes. Dip switches select different display modes.



30-597 Single Cutout
30-597-2 Dual Cutout
15 pin high density "D" cutout single or dual gang stainless steel wall plate with hardware. For Male or Female connectors. Works with Calrad part numbers 30-580, 30-582, 30-587, 30-588.



30-598 Single Cutout
30-598-2 Dual Cutout
15 pin wide "D" cutout single or dual gang stainless steel wall plate with hardware. For Male or Female connectors. Works with Calrad part numbers 30-584-M, 30-584-F and 35-710 DVI-I coupler.



30-599
25 pin "D" cutout single gang stainless steel wall plate with hardware. For Male or Female connectors. Works with Calrad part numbers 30-575, 30-577.



30-574
HDDB 15 pin VGA cutout and DVI cutout on a single gang stainless steel wall plate with hardware. For Male or Female connectors. Works with Calrad part numbers 30-580, 30-582, 30-587, 30-588 and 35-710A.

30-550-ph 9-pin plastic
30-550-mh 9-pin metalized plastic
30-550-m 9-pin metal
30-551-ph 15-pin plastic
30-551-mh 15-pin metalized plastic
30-551-m 15-pin D conn. metal
30-552-ph 25-pin plastic
30-552-mh 25-pin metalized plastic
30-552-m 25-pin metal



Hoods

CALRAD

35 series - Adapters



35-498Bh 4 pin
35-498Bh-6 6 pin
35-498Bh-8 8 pin
 Bulkhead mini-din connector w/ 2 nut mounting. Panel mount 4 pin SVHS Female-Female. Mounts in 1/2" single "D" hole
35-498g -Bh Gold 4 pin version
35-498g -Bh-6 Gold 6 pin version

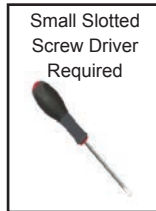

Small Slotted
Screw Driver
Required

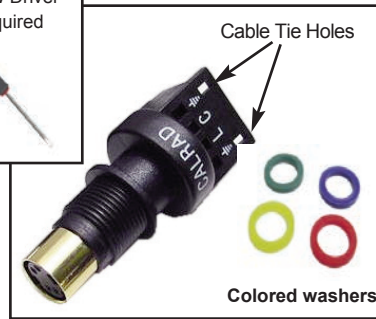

Cable Tie Holes

Colored washers

35-498k -s
 Solderless Keystone or chassis mount SVHS jack with screw terminal connectors. Mounts in 1/2" hole or standard keystone insert. Comes with cable tie for strain relief. Colored ID washers available (30-288-COLOR). Also available in BNC (75-686K-S) and RCA (30-308K-S) versions.



35-498 4 pin
35-498-6 6 pin
35-498-8 8 pin
 Bulkhead SVHS connector with 2 nut mounting. Panel mount 4 pin SVHS Female to Female. Mounts in 1/2" double "D" hole.

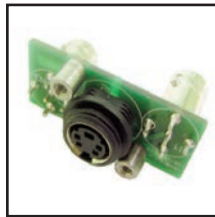

35-494
 SVHS 4 pin Female to 2 Female BNC on circuit board. Panel mount with screw holes. Breaks out C and YC-Y.



35-499
 SVHS Male to RCA Female adapter. Converts SVHS signals to composite video. Bi-directional. Gold plated connectors and black chrome body.



35-499-s F
 SVHS Female to RCA Female adapter. Converts SVHS signals to composite video. Bi-directional. .47" long. Converts SVHS signals to composite video. Bi-directional. Gold plated connectors and black chrome body.



35-499-p economy
 Male SVHS to Female RCA
35-499-s F-p
 Female SVHS to Female RCA
35-499-s-p
 Female SVHS to Male RCA
35-499-BNC-p
 Male SVHS to Female BNC



35-499-s
 SVHS Female to composite RCA Male cable adapter. Converts SVHS signals to composite video. Bi-directional. 6" long. Molded connectors and gold plated contacts.



35-496-4 4 pin
35-496-6 6 pin
35-496-8 8 pin
 Female to Female mini-din coupler, plastic body.



35-497A (18 in.)
35-497A-6 (6 ft.)
 SVHS "Y" adapter. Molded and shielded "Y" cable with 1-Male to 2-Females, pin to pin wiring. Overall length 12". For SVHS signals.



35-497
 SVHS "Y" adapter. non-directional pin-to-pin wiring of luminance and chrominance signals.



35-495
 Midi coupler. 5 pin DIN coupler Female-Female.



35-441
 Fiber-optic toslink coupler. Female to Female. Over all length .72".



35-443
 Fiber-optic toslink Male to 3.5mm Female. bi-directional signal path.



35-440
 Fiber-optic 3.5mm Male to toslink Female bi-directional signal path.



35-444
 Right Angle Toslink Connector 2 piece construction enables the 360° rotation of cable. Female in to Male out.



35-442
 Toslink fiber-optic splitter. Non directional. Connects 3 toslink cables together.



35-439
 Passive 3-way toslink optical switch. Passive selection knob with a spring loaded lock mechanism and selection indicator. Bi-directional switching. Size: 5.5"W x 1.3"H x 4.5"D.

CALRAD

35 series - XLR Adapters



35-456
3 Pin XLR Female
jack to
1/4" stereo plug.



35-457
3 Pin XLR Male
plug to 1/4" stereo
plug.



35-462
3 Pin XLR Female
jack to 1/4" stereo
jack.



35-463
3 Pin XLR Male plug
to 1/4" stereo jack.



35-452
3 Pin XLR Female
jack to
1/4" mono plug.



35-453
3 Pin XLR Male plug
to
1/4" mono plug.

35-450
3 Pin XLR Female
jack to 1/4" mono
jack.

35-451
3 Pin XLR Male plug
to 1/4" mono jack.



35-455
3 Pin XLR Male plug
to
RCA plug.



35-454
3 Pin XLR Female
jack to RCA type
plug.



35-461
3 Pin XLR Male plug
to Female RCA jack.



35-460
3 Pin XLR Female
jack to RCA jack.



35-459
3 Pin XLR Male plug
to BNC jack.



35-458
3 Pin XLR Female
jack to
BNC jack.



35-464
3 Pin XLR Female
jack to 3 Pin XLR
Male plug. Crossing
wire for pin 2 and 3.



35-465
Inline XLR ON/OFF
microphone switch. 3
Pin XLR Male plug to
XLR Female jack
Nickel.

35-465A Brass
Version



30-525
XLR 3 pin Female to
Female coupler.
Wired pin to pin.



30-524
XLR 3 pin Male
to Male coupler.
Wired pin to pin.



35-468
3.5mm stereo
Female jack to XLR
Male.
Wired:
pins 1&3 = ground
pin 2 = tip
8" long with Black
PVC jacket.



35-466
3.5mm stereo
Female jack to XLR
Female. Wired:
pin 1 = ground, pin
2 = tip & ring.
8" long with Black
PVC jacket.



35-469
3.5mm stereo
Female jack to XLR
Male plug.
Wired:
pin 1 = ground
pin 2 = tip
pin 3 = ring.
8" long. Black PVC
jacket.



35-467
3.5mm stereo
Female jack to XLR
Female plug.
Wired:
pin 1 = ground
pin 2 = tip
pin 3 = ring.
8" long with Black
PVC jacket.

35 series - DVi, hDmi, Vg A Adapters



35-713-A
HDMI Female to Female inline Coupler with Gold contacts.

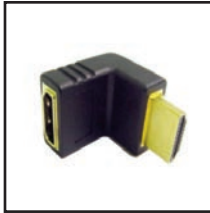

35-714
HDMI Female to Male right angle adapter. Up 90 degrees Gold contacts.



35-714A
HDMI Female to Male right angle adapter. Down 270 degrees. Gold contacts.



35-718, 35-718A hDmi Right Angle Adapter Cables
The 35-718 Series Adapters provide a low profile cable exit solution for tight spaces Behind video displays, A/V receivers, switching and amplifier devices. Length 6".



35-718



35-718A

35-718
Cable exit to top
35-718A
Cable exit to bottom.



35-711A
HDMI Female to DVI-D Male adapter with Gold plated contacts.



35-706
HDMI Female to mini HDMI Male adapter. Gold plated contacts.



35-715
HDMI Female to DVI-D Male Cable Adapter. Gold plated contacts. 6" Length
35-716
HDMI Male to DVI-D Female cable adapter. Gold plated contacts. 6" Length.



35-707
HDMI Female to HDMI panel mount Female 6 inch length. Hardware not supplied.



35-709 hDmi m-F
Low profile right angle adapter for HDMI. Unique flat on side design. Gold plated.



35-728
HDMI Female to Mini HDMI Type C Male adapter cable.



35-726
HDMI Male to Display Port Female adapter.



35-727
DVI-D Female to Male Display Port Male adapter.



35-712A
HDMI Male to DVI-D Female adapter with Gold plated contacts.



35-717
DVI-I Female to M1DA Male plug. Length 6" Gold plated contacts.



35-702
DVI-D Female to DFP 20 Pin Male adapter.
35-703
DVI-D Male to DFP 20 Pin Female adapter.



35-701 DVI-A male to Vg A DB-15 Female Adapter.
This adapter allows you to connect a DVI-A display to a VGA graphics card.



35-700 DVI-i male to Vg A DB-15 Female Adapter
Allows you to connect VGA display to a DVI-I graphics card. Note, this adapter does not provide a digital to analog signal conversion. It will not work with DVI-D.



35-710A DVI-i to DVI-i Female to Female Coupler. Shielded di-cast case handles 5 pin analog and 24 pin digital signals. gold plated contact pins. Used for inline or chassis mount. Overall length .93" For wall mounting use Calrad p/n 30-598.

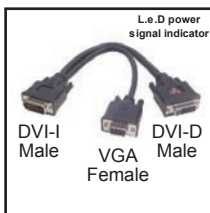

35-601 DVI-I to DVI-D & VGA Splitter
Separates DVI-I Male to DVI-D Female and VGA Female. For use with DVI-I ports that share analog + digital signals.



35-600 DB 15 VGA "Y" cable. 1 Male to 2 Females. 1 ft length. Gold plated.



35-704
15 pin VGA Male to Female right angle adapter for projectors. Cable exits up from the jack.



35-704A
15 pin VGA Male to Female right angle adapter for projectors. Cable exits down from the jack.

CALRAD

35 series - Audio Video Adapters



35-723
'D' Style panel mount HDMI female-panel female feed-thru. Gold plated contacts. Mounts in a .917" hole.



35-729
Display port panel mount feed-thru female to female jack. Mounts in a standard DB9 cutout. Gold plated contacts, includes mounting hardware.



35-722
M1DA Male plug to DB-15 Female plug. 6 inch cord and Gold plated contacts.



35-720
M1DA Male to component video RCA Female jacks. Color coded and Gold Plated.



55-612-sp
HDDB 15 SVGA Male to 3 RCA Plugs Length: 1foot.



35-721
6" DB9 Male to 9 Pin Mini Din Sharp Serial Interface Cable.



35-730
Fixed 3db Component video attenuators. Provides proper video attenuation for large distributed video applications.



35-502g
Triple A/V coupler. With White, Red and Yellow gold plated RCA jacks.



35-510g
Triple RCA coupler for component video. With Red, Green and Blue gold plated RCA jacks.



35-480
Right angle RCA Male to Female adapter, gold plating with teflon insulator.
35-511g
Plastic RCA plug to RCA jack right angle, plastic body with gold plated contacts.



35-481
Long version of 35-480 Right angle RCA Male to Female adapter, heavy duty gold plating with teflon insulator.



35-483
Right angle RCA plug to two RCA jacks, heavy gold plating with teflon insulator.



35-485
"T" adapter, RCA jack to two RCA plugs, heavy gold plating with teflon insulator.



35-482
Right angle RCA plug to two RCA jacks, heavy gold plating with teflon insulator.



35-486
"T" adapter, RCA jack to two RCA plugs, heavy gold plating with teflon insulator.



35-504 Nickel
35-504g Gold
Shielded "Y", RCA plug to two RCA jacks in parallel.



35-516g
Shielded "Y", 1/4" stereo plug to dual Gold RCA jacks.
35-503 Nickel
35-503g Gold
Shielded "Y", 1/4" mono plug to dual RCA jacks.



35-554g
Shielded "Y", 1/4" stereo plug to dual 3.5 mm stereo jacks, gold.
35-574g
Shielded "Y", 1/4" mono plug to dual 3.5 mm mono jacks, gold.



35-586g
Shielded "Y", 3.5 mm stereo plug to dual RCA jacks. Gold.



35-553g -hg
High Grade Gold version
35-519g
Gold version
Shielded "Y", two 3.5 mm stereo jacks to single 3.5 mm stereo plug, gold.



35-575
Shielded "Y" adapter, 1/4" stereo plug to dual 1/4" stereo jacks. Gold.



35-588g
Shielded "Y", 3.5 mm stereo plug to dual 1/4" stereo jacks, gold.
35-584g
Shielded "Y", 3.5 mm mono plug to dual 1/4" mono jacks, gold.



35-488
3.5 mm mono plug to right angle RCA jack, teflon insulator. Gold plated.
35-589
Plastic body and nickel connectors.



35-567
3.5 mm stereo plug to 1/4" stereo right angle jack. Gold.

CALRAD

35 series - Audio Adapters



35-484A
Right angle
stereo 3.5 mm jack to
3.5 mm stereo plug.



35-566
Right angle stereo
1/4" plug to stereo
3.5 mm jack.



35-517-Rt
RCA-type jack to
1/4" mono plug.
Right angle.



35-487
1/4" mono plug to
right angle RCA
jack, teflon insulator.
Gold plated.



35-479
Mono 1/4" Male to
mono 1/4" Female,
right angle.



35-568
Right angle 1/4"
stereo plug to 1/4"
stereo jack.
Nickel plated.



35-445 Mono
35-446 Stereo
1/4" Male to Male
mono or stereo pin
plug adapter.



35-580 Mono
35-580A Stereo
Shielded 1/4" barrel
connector, Female
to Female, in either
mono or stereo.



35-517 Nickel
35-517g Gold
RCA-type jack to
1/4" mono plug.



35-549 Gold
35-549-Nk Nickel
Solid body gold
RCA-type jack to
1/4" mono plug.



35-536 All Nickel
35-536-p Plastic
3.5mm mono jack to
a mono 1/4" plug.



35-550
Plastic/Nickel
35-550g
Plastic/Gold
35-550-Nk
All Nickel
Stereo 1/4" plug to
3.5mm stereo mini
jack.



35-564
3.5 mm stereo jack
to 1/4" mono plug.



35-542
Stereo
1/4" plug to mono
3.5 mm jack.
Shielded.



35-500
1/4" Stereo jack to
1/4" mono plug.



35-522
3.5 mm mono plug to
1/4" stereo jack,
shielded.
Metal housing.



35-543
Stereo 1/4" jack to
3.5 mm mono plug.
Shielded.



35-506 All Nickel
35-506-p Plastic
1/4" mono jack to
3.5mm mono plug.
Shielded. Nickel
plated.



35-544
3.5 mm to
3.5 mm shielded
mono barrel
connector.



35-551
Plastic/Nickel
35-551g
Plastic/Gold
35-551-Nk
All Nickel
Stereo mini 3.5 mm
plug to stereo 1/4" jack.



35-563
1/4" mono jack to
3.5 mm stereo plug.



35-537
1/4" mono jack to
RCA-type plug.
Nickel plated,
shielded.



35-547
Shielded barrel
connector, RCA
Female to 1/4" mono
Female. Nickel
plated.



35-581
Shielded barrel
connector,
3.5 mm stereo jack
to 3.5 mm stereo
jack.

CALRAD

35 series - Audio Adapters



35-538 Nickel
35-538-p Plastic
RCA-type pin jack to
miniature 3.5 mm
mono plug. Nickel
plated, shielded.



35-512
3.5 mm stereo plug
to RCA Female jack.



35-583
2.5 mm mono plug
to RCA jack.



35-565
3.5 mm mono jack
to 3.5 mm stereo
plug.



35-552
3.5 mm mono plug
to 3.5 mm stereo
mini jack.



35-552A
3.5 mm mono
plug to 3.5 mm
stereo mini jack.



35-582 Plastic
35-582-Nk Nickel
2.5mm stereo jack to
a 3.5mm stereo
plug.



35-518 Plastic
35-518-m Nickel
3.5 mm stereo jack
to 2.5 mm stereo
plug adapter.



35-540
3.5 mm mono jack
to 2.5 mm mono
plug. Shielded.
Nickel plated.



35-541
2.5 mm mono jack
to 3.5 mm mono
plug. Shielded.
Nickel plated.



35-539 Nickel
35-539-p Plastic
3.5 mm mono jack
to RCA-type pin
plug. Shielded.
Nickel plated.



35-548
RCA-type pin plug
adapter. Male to
Male RCA plugs.
Gold.



35-546g
Gold,
35-546-Nk
Nickel,
35-545
Female to Female
RCA coupler. Nickel,
plastic barrel.



35-569
Dual Female RCA
barrel jack.
Gold plated.



35-505 Nickel
35-505g Gold
Shielded "Y", one
RCA Female jack to
two RCA Female
jacks.



35-525
RCA plug to two
RCA-type pin
jacks, shielded.
10" long.

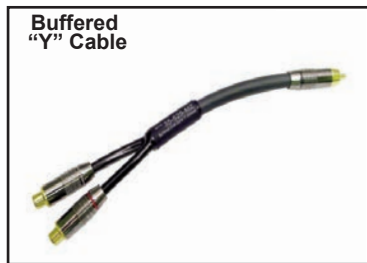

35-525B-mZ
Buffered "Y" Cable
RCA Male to dual RCA Females. Multi-Zone "Y" adapter. Some A/V receivers will short the source signals when the unit is powered off. This adapter prevents this from occurring by using passive circuitry to prevent distortion and signal loss. 8mm OFC cable w/ high quality gold plated connectors 6" in length.

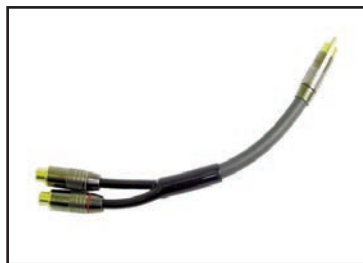

35-525-hg
Shielded 8mm High Grade OFC "Y"
cables with high quality gold plated
connectors. RCA Male to dual RCA
Females. 6" long.
35-525-hgm
Same as HG Version only with Molded
Connectors



35-530-hg
Shielded 8mm High Grade OFC "Y"
cables with high quality gold plated
connectors. RCA Female to dual
RCA Males. 6" long.
35-530-hgm
Same as HG Version only with
Molded Connectors.

CALRAD

35 series - Audio Adapters



35-530
Two RCA plugs to one RCA jack, shielded. 10" long.



35-526
RCA plug to one RCA plug and one RCA jack, shielded. 10" long.



35-578
One RCA jack to dual RCA-type jacks, shielded. 10" long.



35-527
RCA plug to two RCA plugs 10" long shielded.
35-527g-6
6 ft. version, Gold plated.



35-562
3.5 mm stereo plug to dual RCA-type plugs, shielded.



35-558
3.5 mm stereo jack to two RCA-type plugs, shielded.
35-558-6
6' version.



35-529
3.5mm mono plug to two RCA Male plugs, shielded. 12" long.



35-557
3.5 mm stereo plug to two RCA jacks, shielded.



35-478
One 3.5 mm mono jack to two RCA jacks, shielded. 10" long.



35-535
RCA male to two 3.5 mm Female mono jacks, shielded. 7 1/2" long.



35-573
3.5 mm mono jack to two RCA plugs, shielded. 10" long.



35-528
Two RCA jacks to one 3.5mm mono plug, shielded. 10" long.



st eReo miNi "Y" ADAPT eR CABLE
3.5 mm stereo plug to 2 molded RCA nickel-plated Male plugs (black). Shielded cable.
55-899-3..... 3 ft.
55-899-6..... 6 ft.
55-899-12..... 12 ft.
55-899-25..... 25 ft.



35-475
Two 3.5 mm stereo plugs to one 3.5 mm stereo jack, shielded. 10" long.



55-895
3.5mm stereo Y cable One (1) 3.5mm Stereo plug to two (2) 3.5mm Mono plugs. 6.5 feet long.



35-560
3.5 mm stereo plug to two 3.5 mm mono plugs, shielded. 10" long.



35-531
Two 3.5mm mono jacks to one 3.5mm mono plug. Shielded cable. 10 1/2" long.



35-555
Two 3.5 mm stereo jacks to single 3.5 mm stereo plug, shielded.



35-559
3.5 mm stereo plug to two 3.5 mm mono jacks, shielded. 10" long.



35-572
Two 3.5 mm mono plugs to one 3.5 mm mono jack, shielded. 10" long.



35-591
One 1/4" stereo plug to two 3.5mm stereo jacks, shielded. 10" long.



35-561
1/4" stereo plug to two 1/4" mono plugs, shielded. 6 ft. long.



35-501A
"Y" adapter for dual stereo listening. 1/4" stereo plug to two 1/4" stereo jacks. 3 ft. long, shielded.



35-577
1/4" Male mono to two RCA Females, shielded.

CALRAD

35 series - Audio Y Cables, passive Video Baluns



35-570
1/4" mono plug to two 1/4" mono jacks, shielded. 12" long.



35-571
Two 1/4" mono plugs to one 1/4" mono jack, shielded. 11" long.



35-579B
Two mono 1/4" plugs to one 1/4" stereo jack, shielded. 10" long.



35-477
"Y" cable. 1/4" stereo plug to dual 1/4" mono jacks, shielded. 6 ft. long.



35-533
Stereo 1/4" plug to two 3.5mm mono plugs, shielded. 11" long.



35-594
3.5mm stereo jack to two 1/4" mono plugs, shielded. 8" long.



35-532
Stereo 1/4" plug to two RCA plugs, shielded. 10" long.
55-902
5 ft. version.



35-534
Stereo 1/4" plug to two RCA jacks, shielded. 10" long.



35-593
One 1/4" mono jack to two RCA plugs, shielded. 10" long.
55-997
12" stereo version.



35-592
One 1/4" mono jack to two RCA jacks, shielded. 10" long.



35-576
1/4" mono plug to two RCA Male plugs, shielded. 10" long.



35-610
2.5mm Stereo "Y" cable. For cellular telephone interfacing to mic and headphone audio, TRS. 2.5mm R/A Stereo Male to dual 2.5mm stereo Females.



35-590
3.5mm stereo plug to two 1/4" mono jacks, shielded. 11 1/2" long.



35-476
"Y" cable. 3.5mm stereo plug to dual 1/4" mono plugs, shielded. 10" long.



35-556
Two stereo 1/4" jacks to 3.5mm stereo plug, shielded. 11" long.



55-996
"Y" adapter cable. 1/4" stereo jack to dual 3.5mm mono plugs. Parallel wired. Shielded. 12" long.



35-523
3.5mm stereo plug to 1/4" stereo Female jack, shielded. 12" long.



35-524
3.5mm mono plug to 1/4" stereo jack, shielded. 16" long.

small-Compact Audio-Video Baluns

Composite Video + stereo Audio



95-1140 sold in pairs
RCA Jacks RJ45 Jack
supports 480i + stereo Audio

Component Video



95-1144 sold in pairs
RCA Jacks RJ45 Jack
supports 480i, 480p, 720p, 1080i, 1080p

Component Video + Digital Audio



95-1145 sold in pairs
RCA Jacks RJ45 Jack
supports 480i, 480p, 720p, 1080i, 1080p

95-1140 Composite Video + L, R Audio
95-1144 Component Video
95-1145 Component Video + Digital Audio
Calrad's new line of audio-video baluns provide a simple low cost method of delivering analog audio, digital audio + video over UTP cable. 25K Gold plated jacks, Chassis: ABS Plastic. Size: Length 3.16" x Width 2.55" x Height 1.14".

40 series - passive Composite-Component Baluns



95-1040 Composite Video BALUN system

Transmit composite video and L+R analog audio up to 1000' over UTP cat5e or cat6 cable. 3 x RCA female jacks to RJ45 female jack. Units sold individually, 2 pieces required. Non-directional signal use. Size: Length 3.5" x Width 2.2" x Height 1".

Technical Note: Using adapters, the composite video jack can be used to deliver IR as well. Use Calrad 75- adapter for CCTV use.

75-695

Female BNC to Male RCA adapter. Not Included.



95-1044-RCA 95-1044-BNC HDTV Video BALUN system

Video (RGB) balun is designed to transmit Red, Green and Blue (RGB) video signals over CAT 5E/6 UTP cable. Internal inductors and filters ensure stable video signal transmission over UTP cable up to 1000 ft. for a 640 X 480 resolution. Units sold individually, 2 pieces required. Non-directional signal use.

specifications:

Interface video (R) One BNC or RCA Female for RED signal Interface video (G). One BNC or RCA Female for GREEN signal Interface video (B) One BNC or RCA Female for BLUE signal Interface UTP One RJ45 for RGB signal RJ45 pair 4 (pin 7, 8) RED signal Impedance video. 75 ohm unbalanced RJ45 pair 3 (pin 3, 6) GREEN signal impedance RJ45 100 ohm balanced RJ45 pair 2 (pin 1, 2) BLUE signal video bandwidth DC to 30MHz. Color: black. Size: Length 3.5" x Width 2.2" x Height 1".



40-40Ye01D Component Video & Digital Audio BALUN, iR BALUN

HDTV Balun system is designed to transmit Component video (Y,Pb,Pr), selectable switch for digital audio or IR signals over a single Cat5E/6 cable up to 1000 ft for a 640 X 480 resolution. Supports 480I/P, 720P and 1080I. Video bandwidth DC to 60MHz. Two units required, Bi-directional signal system. Passive design with no power required. 4 x RCA Jacks, 1 x removable 2 pin terminal block. Color: black. Size: Length 3.5" x Width 2.2" x Height 1".

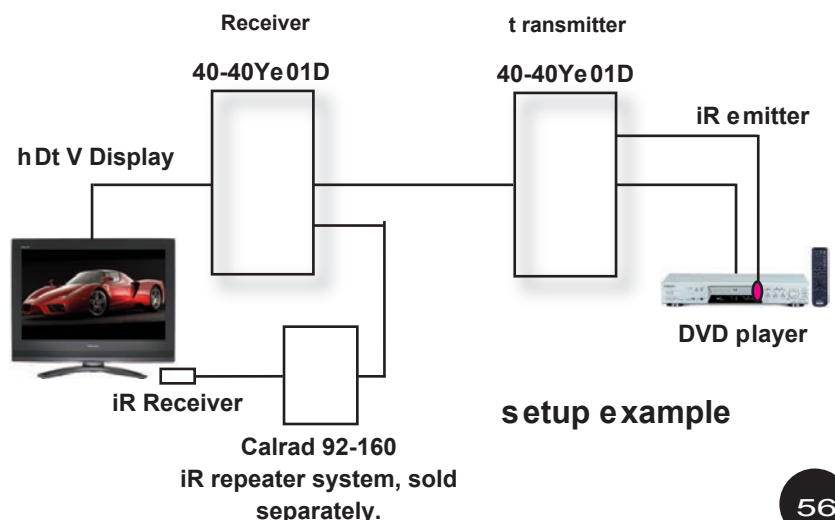
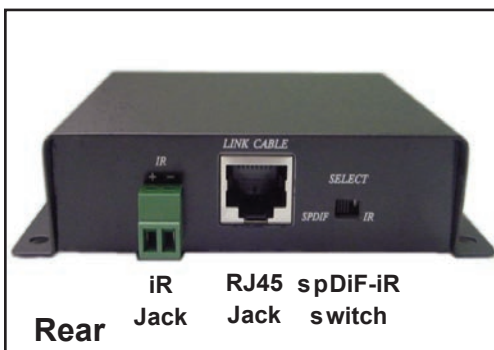

CALRAD

40 series- hDt V A/V Component Distribution Amplifiers

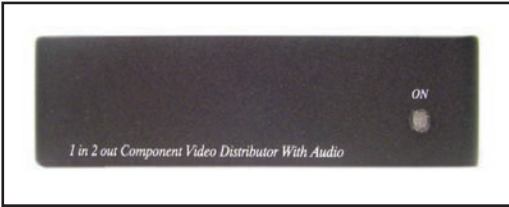

40-YD02A 1 X 2 hDt V AUDIO-Video Distribution Amplifier

The 40-YD02A 1 x 2 component video amplifier with stereo audio allows you to distribute low-noise, low-distortion HDTV component video and analog audio signals to four destinations. Amplified, broadband circuitry eliminates signal loss and assures true one-to-one ratio, low noise, low distortion, unity gain audio and video distribution, and are capable of transmitting signals for cable runs of up to 150 ft. One additional amplifiers may also be cascaded for system expansion. 12Vdc, 1A power supply. Front panel L.E.D. indicator. **Works well with all active and passive component balun systems.**

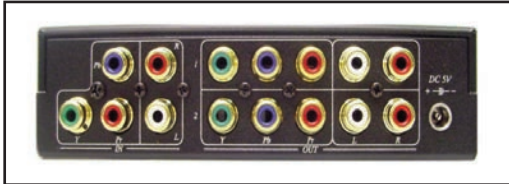

specifications:

Video Input Impedance: 75Ω +5%. Output Impedance: 75Ω +5%
 Video Insertion Loss: 50Hz to 10MHz<.40dB.Video Bandwidth: >100MHz
 Audio Input Impedance: 47K
 Audio Response: >100kHz. Frequency Response: 20Hz to 100kHz
 Signal to Noise: 100 dB@ 2Volts out
 Size: Length 4.75" x Width 3.75" x Height 1.5"



40-937B 1X4 hDt V AUDIO-Video Distribution Amplifier

AmpLiFieR

The 40-937B 1X4 component video amplifier with stereo audio allows you to distribute low-noise, low-distortion HDTV component video and analog audio signals to four destinations. Amplified, broadband circuitry eliminates signal loss and assures true one-to-one ratio, low noise, low distortion, unity gain audio and video distribution, and are capable of transmitting signals for cable runs of up to 150 ft. One additional amplifiers may also be cascaded for system expansion. Includes 12Vdc, 500ma power supply. Tabs with 4x4 mounting holes. Front panel L.E.D. indicator. **please note It his distribution amplifier will not work with passive component balun systems.**

specifications:

Video Input Impedance: 75Ω +5%. Output Impedance: 75Ω +5%
 Video Insertion Loss: 50Hz to 10MHz<.40dB.Video Bandwidth: >100MHz
 Audio Input Impedance: 47K
 Audio Response: >100kHz. Frequency Response: 20Hz to 100kHz
 Signal to Noise: 100 dB@ 2Volts out
 Size: Length 7.5" x Width 3.5" x Height 1.25"

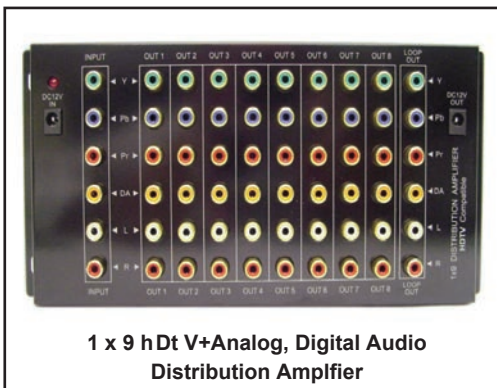

40-939B 1X9 hDt V AUDIO-Video Distribution Amplifier

The 40-939B is a high quality 1X9 HDTV and analog video distribution amp that can transmit digital or analog audio as well as component and composite video signals to five locations up to 150 ft. the Calrad 40-939B has a loop output giving it the ability to be daisy chained to other units, allowing for longer cable runs and AV distribution to more than 5 displays or to feed a local monitor. If the digital audio port is not used it can be used for standard composite video. 9VAc power supply is included. Front panel L.E.D. power indicator.

specifications:

Input impedance: 75Ω + 5% Output impedance: 75Ω + 5%
 Video bandwidth: > 100 MHz Audio response: > 100 KHz
 Input impedance: 22k ohm Output impedance: 1k ohm
 Frequency response: 20 Hz to 100 KHz Supports standard SPDIF digital audio Power Supply: 9VAC@1000 mA.
 Size: Length 9.6" x Width 4.5" x Height 1.25".

40 series - Component Distribution Amplifiers

40-844m 1 X 4 hDt V Dist RiBUt io N AmpLiFieR
 1X4 Component Video and Stereo Audio Distribution Amplifier. 300MHz for HDTV component video and stereo L+R audio. AC adapter included.

specifications:

Type of Video:.....HDTV Component DA
 Video Input/Output:+1Vpp, 75Ω
 Audio Input/Output: Stereo (R+L) 40KΩ
 Terminals Input/Output RCA connectors
 Video Input: ..Component Video YPbPr, YCbCr
 Audio Input:Stereo Audio (R/L)
 Video Output: ..Component Video YPbPr, YCbCr x 4
 Audio Output:Stereo Audio (R/L) x 2

Video Bandwidth:.....>300MHz
 Video Distortion:<1dB (+/- 3dB)
 Audio Distortion:<0.6dB (+/- 3dB)
 Channel Isolation:>50dB
 Signal to Noise Ratio:>50dB
 Dimensions:(L) 8.9" x (W) 6.5" x (H) x 1.25"
 Power Source:5Vdc @ 500mA
 Power Adapter Included

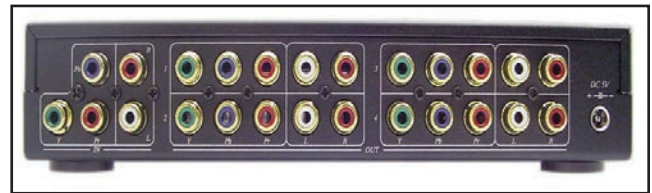
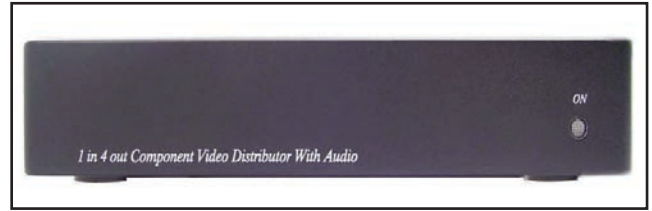

Rear View

40-849m 1 X 8 AIV hDt V Dist RiBUt io N AmpLiFieR
 1 input to 8 outputs for RGBHV or RGB and L+R audio. L+R audio can also be used for PCM digital coaxial. Extends audio and RGB video up to 200'. RCA jacks for RGBHV or L+R audio IN/OUT. The 40-849M distributes HDTV or progressive scan video and analog stereo or digital audio to multiple displays. AC adapter included.

specifications:

t ype of Video.....hDt V Component DA
 Video Input/Output+1Vpp, 75Ω
 Audio Input/OutputStereo (R+L), 40KΩ
 Terminal Input/OutputRCA connectors
 Video Input.....Component Video YPbPr, YCbCr,RGB
 Audio InputAR/AL (H, V, PCM, Coaxial)
 Video Output.....Component Video YPbPr, YCbCr, RGB X 8
 Audio Output ...AR/AL (H, V, PCM, Coaxial) x 8

Video Bandwidth:.....>700MHz
 Video Distortion:<1dB (+/- 3dB)
 Audio Distortion:<0.6dB (+/- 3dB)
 Channel Isolation:>50dB
 Signal to Noise Ratio:>50dB
 Dimensions:(W) 17.4" x (D) 7.90" x (H) x 1.73"
 Power Source:12Vdc @ 1 AMP
 Power Consumed.....@900ma Maximum

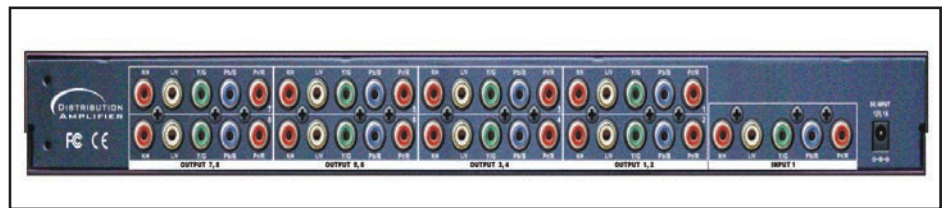
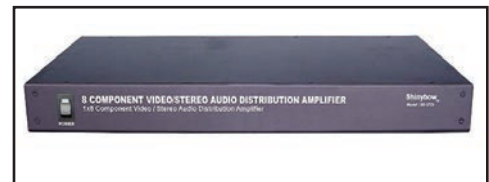

Rear View

Front View

40-848m 1 X 8 AIV hDt V Dist RiBUt io N AmpLiFieR 1 ghz
 1X8 Component Video and Stereo Audio Distribution Amplifier.1 GHz for HDTV component video and stereo L+R audio. Fits standard 19 inch rack mount for easy installation. AC adapter included.

specifications:

Video Bandwidth: >1 GHz
 Video Distortion: <1dB (+/- 3dB)
 Audio Distortion: <0.6dB (+/- 3dB)
Channel isolation: >50dB
 Signal to Noise Ratio: >50dB
 Dimensions: (W) 17.4" x (D) 7.90" x (H) x 1.73"
 Power Source: 12Vdc @ 1 AMP
 Power Consumed.....900ma Maximum

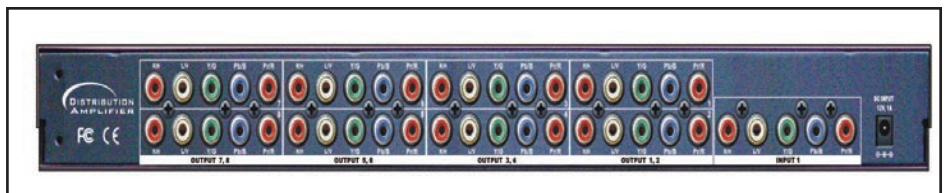

Rear View

40 series - Component Video switchers

40-5526 4X2 Compo NeNt ViDeo mAt RiX sWit CheR

Capable of switching HDTV Component Video, PCM, Optical and Stereo Audio signals between four sources and two displays with compatible inputs. A maximum bandwidth of 325MHz will support HDTV resolutions of up to 1080P. Because it is a matrix switcher, it allows any input to be routed to any output; or the same input to be routed to all outputs. IR remote control or manual push button controls for switching inputs or programming the switcher. The RS-232 control allows the switcher to be controlled by a PC. 12Vdc power supply and RS-232 driver CD included.

specifications:

Video Amplifier Bandwidth: >325MHz Resolutions: 480P, 720P, 1080i, 1080P
 Audio/Video Input Connectors:
 4 sets of 6-RCA & 1-Optical (Y/Pb/Pr, AI/Ar, PCM, TosLink)
 Audio/Video Output Connectors:
 2 sets of 6-RCA & 1-Optical (Y/Pb/Pr, AI/Ar, PCM, TosLink)
 Net Weight: 2lbs Power Supply: 12VDC; 500mA~3000mA
 Dimensions: Length 17.5" X Width 7.8" X Height 1.75"

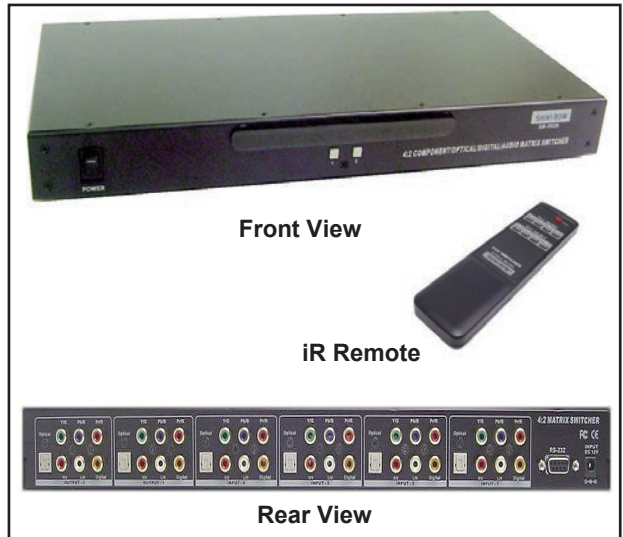

40-963m 6 X 4 Compo NeNt A/V mAt RiX sWit CheR

Capable of switching HDTV Component Video and Stereo Audio signals between six sources and four displays. A maximum bandwidth of 325MHz will support HDTV resolutions of up to 1080P. Because it is a matrix switcher, it allows any input to be routed to any output; or the same input to be routed to all outputs. IR remote control or manual push button controls for switching inputs or programming the switcher. The RS-232 control allows the switcher to be controlled by a PC. 12Vdc power supply and RS-232 driver CD included.

specifications:

Video Amplifier Bandwidth: >325MHz
 Resolutions: 480P, 720P, 1080i, 1080P
 Video Input Connectors: 6 sets of 5-RCA (Y/Pb/Pr and Left & Right Audio)
 Video Output Connectors: 4 sets of 5-RCA (Y/Pb/Pr and Left & Right Audio)
 Power Supply: 12VDC; 500mA~3000mA
 Dimensions: Length 17.5" x Width 8" x Height 1.75"

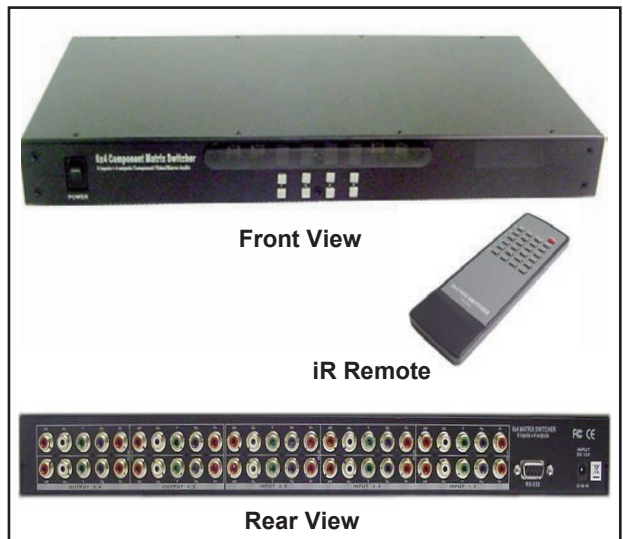

40-964m 4X4 Compo NeNt ViDeo mAt RiX sWit CheR

High speed 4X4 Component Video Matrix Switcher with both PCM Digital Audio and Analog Stereo Audio. The Switch has 8 individually assignable inputs and outputs. Any input may be switched to any output; or the same input may be switched to all outputs in any combination. For use with High Definition LCD Television or Plasma displays. Switching control is accomplished by Front push buttons with LED read out or IR remote control. A Windows-based control software package is included to provide complete control of the Switchers by RS232. IR remote control included. 12Vdc power supply included.

specifications:

Video Amplifier Bandwidth: >350MHz Resolutions: up to 1080P
 Video Input Connectors: 4 sets of 6-RCA (Y/Pb/Pr, AI/Ar, PCM)
 Video Output Connectors: 4 sets of 6-RCA (Y/Pb/Pr, AI/Ar, PCM)
 Power Supply: 12VDC; 1000mA~3000mA
 Dimensions: Length 17.5" x Width 8" x Height 1.75"

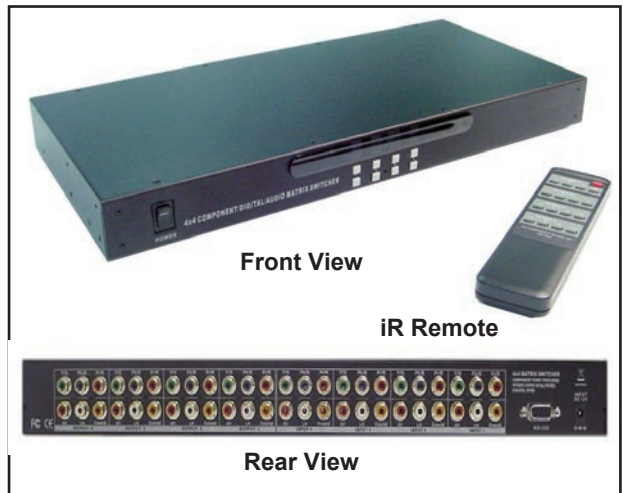

CALRAD

40 series - VgA, hDmi, Component Video Converters/s calers

40-281h Co mpo NeNt ViDeo t o hDmi CoNVeRt eR

Convert Y, Pb, Pr component video and analog or digital audio to HDMI 1.2 or DVI 1.0. Supports 480i, 480P, 720P, 1080i and 1080P. The 40-281H has RCA jacks for Component video inputs, PCM digital audio and 3.5 mm stereo audio. The audio input select switch allows you to switch between analog or digital audio in. 5 Volt DC power supply included.

specifications:

Input Component video, 3 x RCA jacks for Y, Pb, Pr 1x 3.5mm stereo jack for analog audio, 1 x RCA jack for PCM digital audio Output: One HDMI Female port.

Dimensions: Length 4.2" X Width 3.0" X Height 1.2"

Power: 5 Volt DC

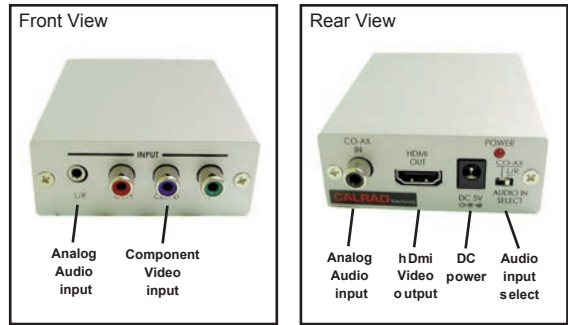

40-283hD hDmi 1.2 t o Co mpo NeNt ViDeo CoNVeRt eR

The 40-283HD allows you to switch between two HDMI 1.2 inputs and convert them to component video (Y, Pb, Pr) and analog or digital audio out. Supports 480i, 480P, 720P, 1080i and 1080P resolutions. IR remote control is used for power on/off and selecting between the 2 HDMI inputs. If the HDMI 1.2 inputs are HDCP encrypted the component video output will be turned off. 5Volt DC power supply included.

specifications:

Output: Three RCA jacks for Y, Pb, Pr. One 3.5mm stereo jack for analog audio. One RCA jack for PCM digital audio Output: Two HDMI Female ports. Dimensions: Length 4.2" X Width 4.0" X Depth 1.2", Power: 5Volt DC

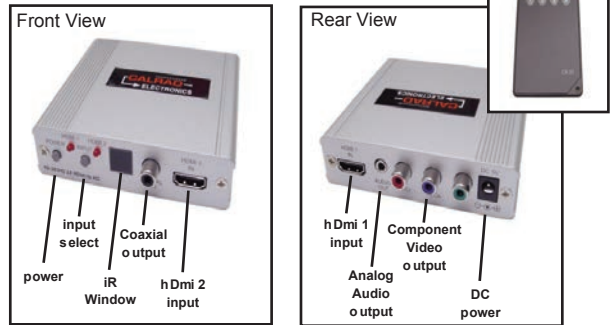

40-480 VgA t o Co mpo NeNt ViDeo CoNVeRt eR Wit h o sD (oN sCReeN DisPLAY) set Up meNU

Converts VGA to component video (Y, Pb, Pr). VGA to Converter Box can convert XGA (VGA /SVGA/XGA /SXGA) to YpbPr video, allowing connection of PC based devices for viewing on high-definition component video displays. This converter box provides you with a economic, high-efficient and perfect video converter solution. Settings include brightness, contrast, color saturation and hue. Select 4:3, 16:9 or full screen display modes. Both PC and MAC Computer are supported. Standard resolutions are 480i, 576i, 480P, 576P, 720P, 1080i. Size: Length 5" x Width 3.7" x Height 1.33".Includes 5Vdc, 1Amp power supply, 3 ft. VGA and component video cables.

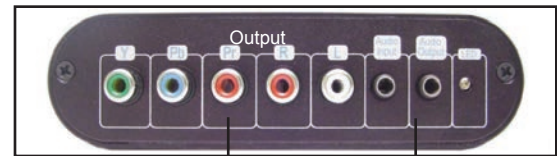
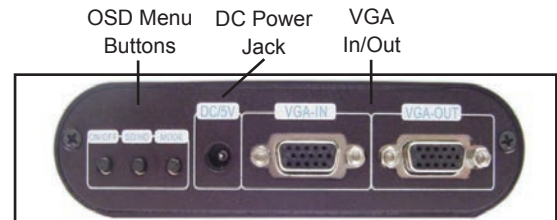

RCA Component Video + Audio 3.5mm PC Audio, In/Out

40-481 Co mpo NeNt t o VgA ViDeo CoNVeRt eR Wit h o sD (oN sCReeN DisPLAY) set Up meNU

Converts component video (Y, Pb, Pr) to VGA video. YpbPr Video to VGA Converter Box can convert YpbPr video to XGA (VGA /SVGA/XGA /SXGA), allowing connection of PS2, PS3, Xbox, Xbox360, Wii, Game Cube, CRT or LCD, Apple TV, Vudu Box, or Netflix Roku Player to a computer monitor, projector, or other display that supports VGA, and allowing viewing high-definition DVD and picture on PC. This converter box provides you with a economic, high-efficient and perfect video converter solution. Settings include brightness, contrast, color saturation and hue. Select 4:3, 16:9 or full screen display modes. Both PC and MAC Computer are supported. Standard resolutions are 480i, 576i, 480P, 576P, 720P, 1080i. Size: Length 5" x Width 3.7" x Height 1.33". Includes 5Vdc, 1Amp power supply. Includes 3 ft. M-M component video and M-M audio cables.

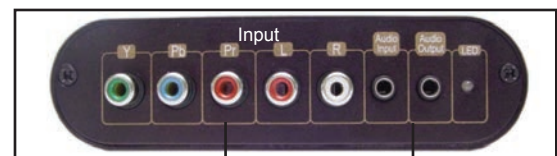
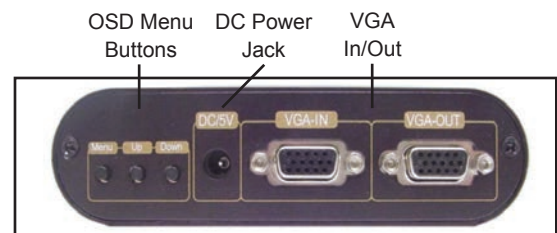

RCA Component Video + Audio 3.5mm PC Audio, In/Out

40 series - VgA, Component, Composite Video Converter/scalers

40-482 VgA \ CoMpoNeNt ViDeo t o hDmi CoNVeRt eR

Includes 3 ft. VGAM-M video and 3.5mm M-M audio cables. Front panel L.E.D. power indicator. If you have PC or Laptop with VGA output, or you have a device like PSP, DVD, Wii, X-box with component output, and you wish to connect it to an HDTV. The 40-482 has a builtin scaler that up-scales a standard analog VGA signal or Component Video with audio to a single HDMI output. The output is fixed at 720p to avoid compatibility problems. Size: Includes 5Vdc, 2A power supply, 3 ft. VGA M-M, 3.5mm M-M cables.

Accepts these PC VGA resolutions: 640x480 (60Hz, 75Hz, 85Hz), 800x600(60Hz, 75Hz, 85Hz), 1024x768 (60Hz, 75Hz, 85Hz), 1280x720 (60Hz), 1280x768(75Hz), 1280x960(60Hz).

Accepts these Component Video (Y,Pb, Pr) resolutions: 480i (60Hz), 480P (60Hz),576i (50Hz), 576P(50Hz),720P (50Hz, 60Hz).

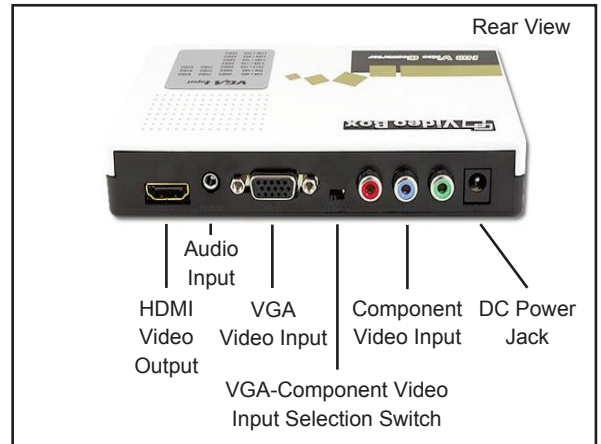

40-720pHD CoMposit e ViDeo \ s-ViDeo t o hDmi CoNVeRt eR

The 40-720PHD converts composite video/s-video/stereo audio to HDMI. Accepts NTSC 3.58, Pal-M and Pal-N composite video and S-Video inputs as well as 3.5mm stereo audio and converts the signals to 720P HDMI with audio. Audio is incorporated into the HDMI output as well as the 3.5mm stereo output simultaneously. Video inputs auto detect video source and a front panel L.E.D. indicates shows Red for S-Video, Green for composite video. Selectable vertical rates of 50/60Hz. DVI-D compatible with Calrad adapter 35-712A (Not Included). 5Vdc power supply included. Size: Length 5.75" x Width 3" x Height 1.25".



Front View



Rear View



35-712A
HDMI Male to DVI-D Female Adapter with Gold plated contacts.



40-VsRgB CoMposit e ViDeo \ s-ViDeo t o CoMpoNeNt ViDeo CoNVeRt eR / sCALeR

The 40-VSRGB Converts composite video and S-video to component video Y, Pb, Pr or Y, Cb, Cr. Easy plug and play automatically senses input source system. Will work with NTSC 3.58, NTSC 4.43, Pal-M, Pal-N and Secam formats. Selectable inputs between RCA composite video and 4 pin S-video also selectable outputs between Y, Pb, Pr or Y, Cb, Cr. Size: Output cable and 5Vdc power supply included. L.E.D signal indicator, Green=composite video, Red=S-Video, Flicker=no synce. Size: Length 4" x Width 2.5" x Height 1".



40-880A t Wo WAY pC \ CoMpoNeNt oR CoMpoNeNt \ pC CoNVeRt eR Wit h oSD

This Bi-directional 2 way scaler converts PC VGA to HD component video or HD component video to PC VGA. Supports HD resolutions of 480P, 720P, 1080i and 1080P and PC resolutions of VGA, SVGA, XGA, SXGA, UXGA, WXGA, WSXGA and WUXGA. The comprehensive OSD menu allows users to adjust output resolutions, contrast, brightness, hue, saturation and sharpness. Loop out for local monitor. 5 Volt DC power supply and VGA, VGA to Component cables are included.

specifications:

Input port: 1 X HDDB15 Female
Output port: 1 X HDDB 15 Female
Loop port: 1 X HDDB15 Female
Power Supply: 5Vdc, 1A
Dimension: Length 5.75" X Width 4" X Height 1"

oSD menu Controls



CALRAD

40 series - Component Video Converters/Baluns/Adapters

40-888 VgA, hDt V Compo NeNt ViDeo t o s-ViDeo, Composit e ViDeo, 480i Compo NeNt ViDeo CoNVeRt eR/sCALeR

The 40-888 allows you to convert VGA or 480i component video to composite video or S-Video. Supports NTSC 3.58, NTSC 4.43, Pal-M, Pal-N or Secam formats. Switchable component video or VGA inputs. Manual push button or IR remote controlled. RS232 for PC control. Easy to use OSD menu allows you to change output resolution, brightness and contrast. Supports input resolutions of 640X480, 800X600, 1024X768 and 1280X1024. Output resolution 480I or 480P. Includes 3 ft. VGA cable, 3 Ft., component video cable, 3 ft. composite video cable, 3 ft. s-video cable, IR remote control, 5Vdc power supply. Size: Length 8" x Width 6" x Height 2".

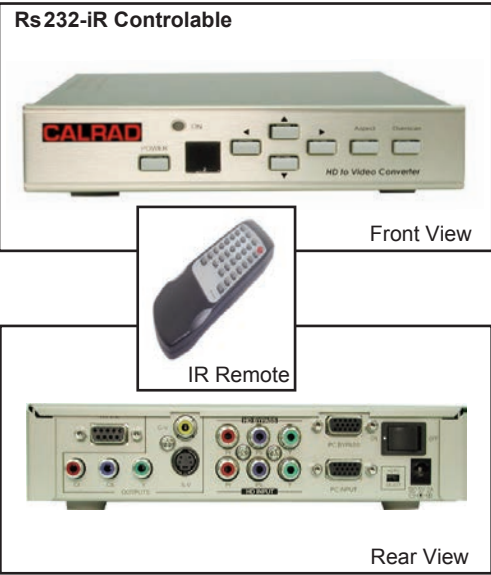
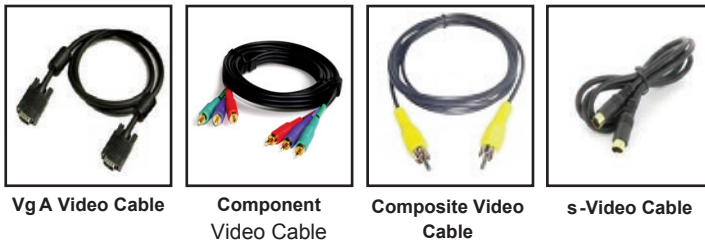

28-202D pAssive Compo NeNt ViDeo BALUN Wit h Desig NeR st YLe WALLpLAT e

RJ45 or punchdown termination. Works with Cat 5 or Cat5e UTP cable Depth 2.5", works with Calrad 95-1044. RCA desktop Balun unit. RCA connectors on front. Wall Plate included. Distance capability
480p.....300 feet
720p.....200 feet
1080i.....100 feet

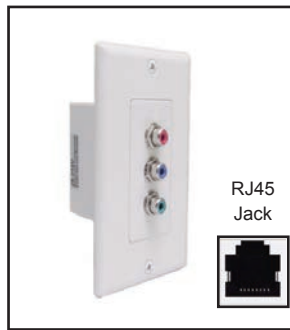

35-730 Compo NeNt ViDeo At t eNUAt o Rs

provides proper video attenuation for large distributed video applications, gold plated male to female adapters, 75 ohm, provides 3db of attenuation. Green, Blue and Red color coded inserts.



40-YW01D siNg Le CAT 5e o R CAT 6 Desig NeR st YLe Compo NeNt FLUsh mo UNT BALUN Wit h Dig it AL AUDio

40-YW01D HDTV Balun system is designed to transmit Component video (Y,Pb,Pr) and digital audio over a single Cat5E/6 cable. Supports 480i/p, 720p and 1080i. Two units required. Bi-directional signal design. Passive design with no power required with built in cable distance equalizer circuit. Single RJ-45 Jack, 4 x Gold RCA Jacks. Sturdy White Plastic Designer Style enclosure. Includes wallplates and mounting hardware.



55-612-sp HDDB 15 SVGA Male to 3 RCA Male plugs, Length: 1ft..



35-510g Gold plated RCA jacks used to extend component video cables. Green, Blue and Red colored inserts. Black plastic molded body labeled Y, Pb, Pr.



35-720 M1DA Male to component video RCA Female jacks. Gold plated connectors. Green, Blue and Red color coded inserts.



40 series - Baluns/Composite Video Amplifiers

40-DA01 BALANCEd pAssive sigNAL CoNVeRt eR 40-DA02 BALANCEd pAssive sigNAL CoNVeRt eR With 4" WiRe pig t AiL

Passive bi-directional signal design using UTP Cat5e or Cat6 cable pair. Use for Audio\Video\Component\IR signals.

Cable Distance:

Analog Audio, 1000 ft. Digital Audio, 300 ft. IR Signals, 300 ft.
Composite video, 1000 ft., High Definition 480P - 300 ft.,
720P - 200 ft., 1080i -100 ft., 1080P - 50 ft.

Wire t ermination

40-DA01: 2 Conductor captive screw terminals

40-DA02: 2 conductor locking style punch down blocks for easy wire

specifications

Bandwidth: DC to 50Mhz, DC passive

Connectors: RCA Male Plug

Signal Types: Analog+Digital Audio \ Video \ IR Signals

Housing Material: Plastic, Color: Black

Dimensions: 1.76"(L) x .68"(W) x .68"(H)

Dimensions: Length 1.32" x Width 0.6" x Height 0.6"

40-DA01Male RCA Plug spacing .64 inch center to center

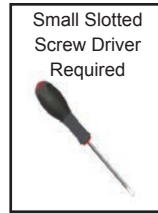

40-804m Composite 1 x 4 Video, stereo AUDIO Dist RiBUt ioN Amp

The 40-804M 1X4 composite video and stereo audio amplifier gives you the ability to distribute low-noise, low-distortion signals to either four or seven destinations if you daisy chain two amplifiers. Amplified, broadband circuitry eliminates signal loss and assures true one-to-one ratio, low noise, low distortion, unity gain audio and video distribution. Video bandwidth 480i. Front panel L.E.D indicator. Includes 5Vdc AC adaptor. Size: Length 8.8" x Width 6.5" x Height 1.7".

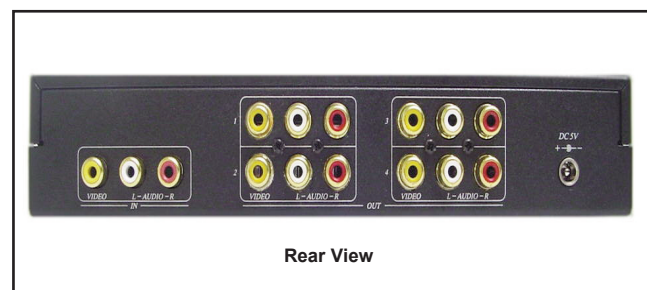
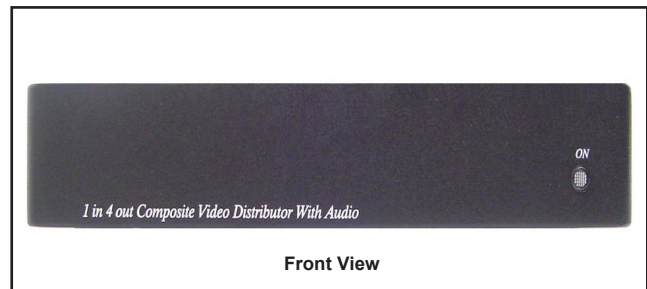

40-936B Composite-SVHS Video, stereo AUDIO Dist RiBUt ioN Amp

The 40-936B 1X4 composite-SVHS video and stereo audio amplifier gives you the ability to distribute low-noise, low-distortion signals to either four or seven destinations if you daisy chain two amplifiers. Amplified, broadband circuitry eliminates signal loss and assures true one-to-one ratio, low noise, low distortion, unity gain audio and video distribution. Video bandwidth 480i. Includes 12Vdc AC adaptor. Size: Length 7.5" x Width 3.6" x Height 1.25".



CALRAD

40 series - Composite Video Amplifiers



Front View



Rear View

40-809-8, 8 port Audio\Video Dist RiBUt io N AmpLiFieR

1 input to 8 buffered and isolated outputs. L.E.D.power indicator. Extends audio and composite video up to over 200'. RCA jacks IN\OUT. This product is perfect for multi-TV demo's, CCD camera feeds, and home theater systems. Front panel power switch, AC adapter included.

specifications:

iNpUt :

Type of Video.....Composite video (V/C) x 1
 Video Input..... +0.3 Vpp: 75Ω
 Audio Input..... Stereo (R+L): 40KΩ
 Terminals Input RCA x 1 Jack / Audio x 2 RCA

Video Bandwidth >5Mhz
 Video Distortion<1.2dB (+/-) 3dB
 Audio Distortion<0.6dB (+/-) 3dB
 Extension Distance 0-50 M
 Dimensions..... Length: 11.750 x Width 5" x Height 1.75"
 Weight.....1435 gm
 Power Supply..... 9Vdc, 300ma

oUt pUt :

Video Output 8 x RCA Female Jacks
 +.03 Vpp: 75Ω
 Audio R+L Output RCA connectors 16 RCA Female Jacks (8 x 2)
 Output Impedance Stereo (R+L) 40KΩ

40-812 Nt sC ViDeo CoNDit io NeR

This unit is used for connecting DVD players to combo NTSC TV/VCR units. Removes interfering AGC or encoding signals associated with interfacing a DVD player to a VCR. Uses digital processing circuitry to maintain AGC and video contrast. RCA In/Out jacks. Includes video cable and power supply. One input to one output.

40-812 -5

This unit is used for connecting DVD players to combo NTSC TV/VCR units. Removes interfering AGC or encoding signals associated with interfacing a DVD player to a VCR. Uses digital processing circuitry to maintain AGC and video contrast. RCA In/Out jacks. Includes video cable and power supply. One input to five outputs.



40-838-RCA

40-838-BNC (Same as 40-838 only with BNC connectors)

1 X 8 Composite (RCA) ViDeo Dist RiBUt io N AmpLiFieR

RCA composite video distribution amplifier with 1 RCA or BNC video in to 8 RCA or BNC video out. This unit can be used for composite video signals from a DVD or VCR as well as CCTV cameras. AC adapter included.

specifications:

iNpUt :

Video System NTSC/PAL Video (composite)
 Video Input0.50Vpp~2Vpp, 75Ω
 Input Terminal.....RCA connector x 1

Video Bandwidth.....250MHz (+/- 3dB)
 Video Distortion>1.2dB
 Power Consumed....@350mA Maximum
 Power Source12Vdc, @500mA
 AC Power Adapter Included

oUt pUt :

Video System NTSC/PAL Video (composite)
 Video Output1Vpp, 75Ω
 Output terminalsRCA connectors X 8

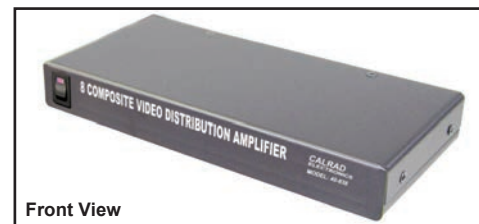

Front View



Rear of RCA Version



Rear of BNC Version

40 series - Composite Video Amplifiers

40-839 1 X 8 s-ViDeo Dist RiBUT io N AmpLiFie R

S-Video distribution amplifier with 1 SVHS Female input to 8 SVHS Female outputs. This unit can be used for composite video signals from a DVD player or S-Video VCR. AC adapter included.

specifications:

iNpUt :

Video System: NTSC/PAL S-Video (Y/C)
Video Input:0.50 Vpp. ~2Vpp, 75Ω
Input Terminal: S-VHS Mini-Din 4 Pin x 1

oUt pUt :

Video System: NTSC/PAL S-Video (Y/C)
Video Output:1 Vpp, 75Ω
Output Terminals: S-VHS Mini-Din 4 Pin x 8

Video Bandwidth:250MHz, (+/- 3dB)
Video Distortion:>1.2dB
Power Consumed: @ 350mA Maximum
Power Source: 12Vdc @ 500mA (included)

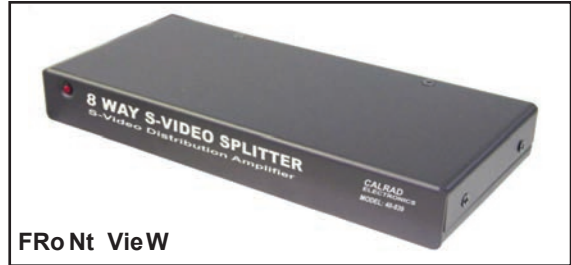

FRoNt VieW

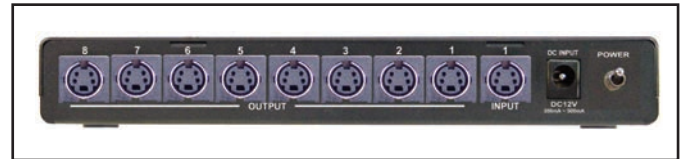

ReAR VieW

40-930m 1X8 s-ViDeo Dist RiBUT io N AmpLiFie R

The 40-930M 1 X 8 S-Video (Y/C) with Analog Stereo Audio and Digital Audio Distribution Amplifier has one Input for S-Video and Gold Plated RCA jacks for composite video and audio. Eight outputs are also S-Video and RCA composite video and audio. Front panel on/off switch. Video amplifier bandwidth: 700MHz. Digital audio bandwidth: 110MHZ. Audio frequency response: 20Hz - 20KHz. Power supply: 12VDC; 1.2A included. Dimensions: Length 6.4" x Width 17" x Height 1.75".

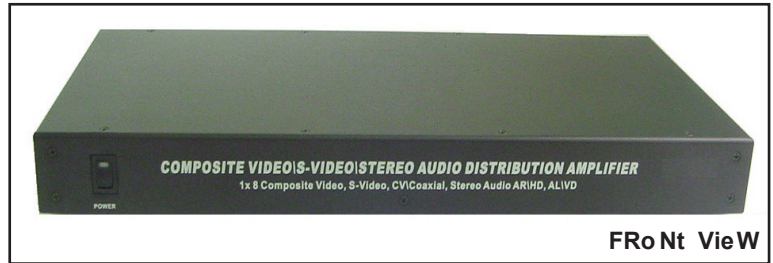

FRoNt VieW

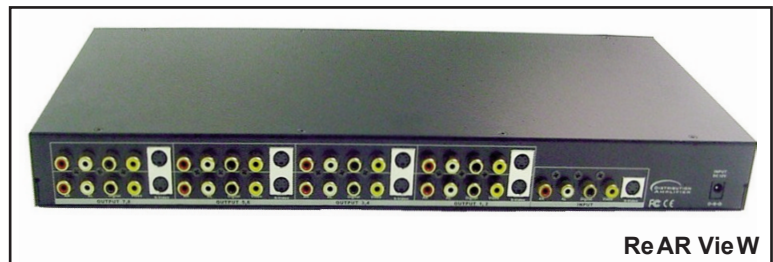

ReAR VieW

40-827m 1 X 16 AUDio / ViDeo

Dist RiBUT io N AmpLiFie R

Composite Video/Stereo Audio Distribution Amplifier. Includes AC power adapter.

specifications:

iNpUt :

Type of Video: Composite Video x 1 Output:
Video Input:+1 Vpp, 75Ω
Audio Input:Stereo (R+L) 40KΩ
Terminals In/Out: ...RCA Jacks (Female)
Dimensions: Length 5.9" x Width 17.32" x Height 2.6"
Power Source 12Vdc, @500ma pos. center
AC Power Adapter Included.

oUt pUt :

Video Output: Composite Video x 16
+1Vpp 75Ω
Audio R+L Output: RCA jacks (Female) x 16
Stereo (R+L), 40KΩ
Video Bandwidth: >250 MHz
Video Distortion: <1.2dB (+/- 3dB)
Audio Distortion: <0.6dB (+/- 3dB)
Channel Isolation: >50dB
Signal to Noise Ratio: <50dB

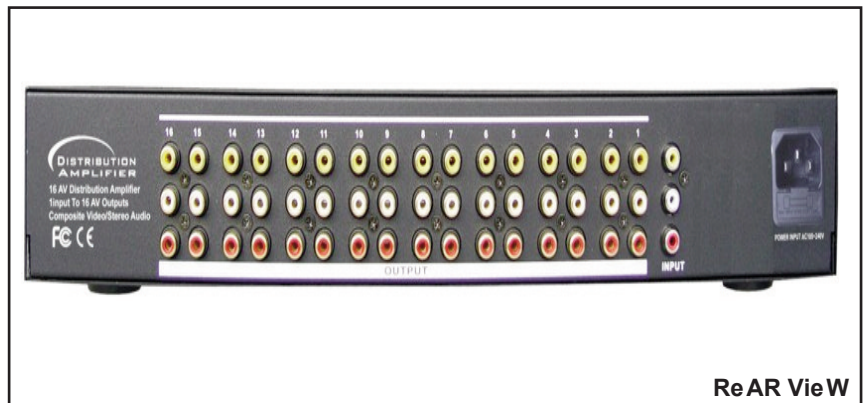

ReAR VieW

CALRAD

40 series - Composite-S-Vhs Video s witchers

40-841m 4 X 2 Co mposit e/s-ViDeo mAt RiX sWit CheR

Remote/Manual controlled 4 inputs to 2 outputs composite/S-Video Matrix switchers with audio combined. Comes with IR remote control (batteries included) A/V input cable and DC power supply. Composite/S-Video bandwidth up to 100 Mhz. Switching Control: Via Infra Red Remote Control or front panel manual push buttons. Individual L.E.D. indicators display Output-A, Output-B input selections. 40-841M-RS232 interface adapter sold seperately.

specifications:

iNpUt :

Video Terminals..Composite & SVHS Jacks x 4
Video Input.....+1Vpp, 75Ω
Audio Terminals RCA Jacks x 12
Audio InputStereo (R+L), 40Ω

o Ut pUt :

Video Terminals..Composite & SVHS Jacks x 2
Video Output.....+1Vpp, 75Ω
Audio OutputStereo (R+L), 40KΩ

Video Bandwidth.....>250MHz
Video Distortion<1.2dB (+/- 3dB)
Audio Distortion<0.6dB (+/- 3dB)
Channel Isolation>50dB
Signal to Noise Ratio.....<50dB
Dimensions ...9"(W) x 5.2"(D) x 1.70"(H)
Weight (unit only)580 gm
Power Consumed...@350mA Maximum
Power Source 5Vdc, @2A
AC Adapter Included

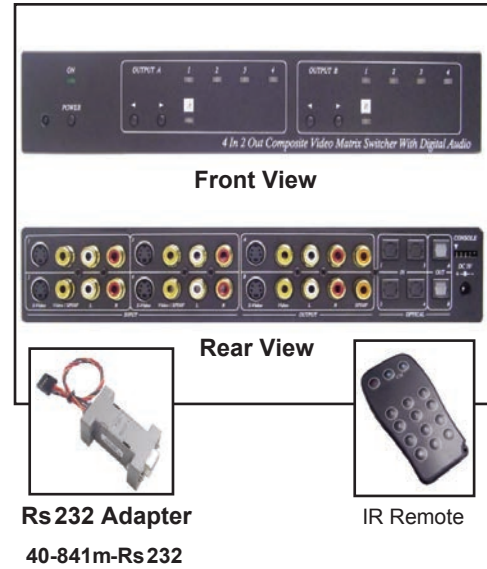

Rs 232 Adapter
40-841m-Rs232

40-948m 8 X 8 AUDIo\ViDeo Co mposit e mAt RiX sWit CheR

IR Remote or Manual controlled 8 input to 8 output RCA composite video and L+R audio Matrix switcher. Comes with IR remote control (batteries included) A/V input cable and DC power supply. Composite Video bandwidth up to 250 Mhz.

specifications:

iNpUt :

Video Input.....Composite Video x 8
.....+1Vpp, 75Ω
Audio InputStereo (R+L), 40KΩ
Terminal InputRCA Jacks x 24

o Ut pUt :

Video Output.....Composite Video x 8
.....+1Vpp, 75Ω
Audio R+L Output..... RCA Jacks x 16
Video Bandwidth.....>250MHz

Video Distortion<1.2dB (+/- 3dB)
Audio Distortion<0.6dB (+/- 3dB)
Channel Isolation>50dB
Signal to NoiseRatio.....<50dB
Video Crosstalk<60dB
Dimensions 17.3(W)x 5.90"(D) x 2.60"(H)
Weight (unit only)1560 gm
Power Consumed...@500mA Maximum
Power Source 12Vdc @1Amp
Power Adapter Included



40-940m 8 X 4 Composite Video/s-Video matrix switcher

The 40-940M has eight S-Video, composite video and stereo audio inputs to four S-Video, composite video and stereo audio outputs. A maximum bandwidth of 250MHz will support 480P and 720P resolutions. IR remote control or manual push button programming allows you to assign any input to any output. RS232 interface allows you to control and program the switcher with PC controlled software. 12Vdc power supply included.

specifications:

iNpUt :

Video Terminals..Composite & SVHS Jacks x 8
Video Input.....+1Vpp, 75Ω
Audio Terminals RCA Jacks x 16
Audio InputStereo (R+L), 40Ω

o Ut pUt :

Video Terminals..Composite & SVHS Jacks x 4
Video Output.....+1Vpp, 75Ω
Audio OutputStereo (R+L), 40KΩ

Video Distortion<1.2dB (+/- 3dB)
Audio Distortion<0.6dB (+/- 3dB)
Channel Isolation>50dB
Signal to NoiseRatio.....<50dB
Video Crosstalk<60dB
Dimensions 17.3(W)x 5.90"(D) x 2.60"(H)
Weight (unit only)1560 gm
Power Consumed...@500mA Maximum
Power Source 12Vdc @1Amp
Power Adapter Included

40 series - Composite-sVhs Video switchers

40-830m 4 X 4 AUDIo \ViDeo CoMposit e mAt RiX sWit CheR

IR Remote or Manual controlled 4 input to 4 output RCA composite Video Matrix switcher with audio combined. Comes with remote control (batteries included) A/V input cable and AC power adapter. RCA Composite Video bandwidth up to 100 MHz.

specifications:

iNpUt :

Video InputComposite Video x 4
+1Vpp, 75Ω
Audio InputStereo (R+L), 40KΩ
Terminals Input.....RCA Jacks x 12

Video Bandwidth.....>100MHz
Video Distortion<1.2dB (+/- 3dB)
Audio Distortion<0.6dB (+/- 3dB)
Channel Isolation>50dB
Signal to Noise Ratio>50dB
Video Crosstalk<60dB
Dimensions 12"(W) x 5.90"(D) x 1.73"(H)
Weight (unit only)1360 gm
Power Consumed@500mA Maximum
Power Source12Vdc, @1Amp

oUt pUt :

Video OutputComposite Video x 4,1Vpp, 75Ω
Audio R+L Output.....RCA Jacks x 8
Stereo (R+L), 40KΩ

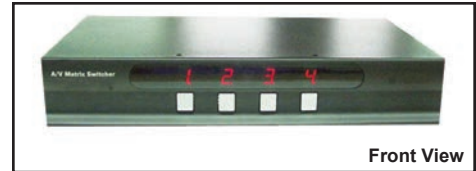

Front View



Rear View

40-803 4 X 2 sVhs ViDeo AND st eReo AUDIo AUt o sWit CheR

4 inputs, 2 outputs. This device switches between 4 s-video/audio sources automatically. When a video signal is detected from 1 of the 4 inputs that channel's video and audio are switched to the output. To select a different input simply turn on that piece of equipment and the video and audio signals will override the previous signal and route it to the output. Switching is automatic with no user interaction. This unit can easily be hidden behind the equipment and provides a simple solution for switching video devices. A L.E.D. indicator is provided on the front panel for visual indication of what input is selected. Unit can also be operated manually. AC Power adapter Included.

specifications:

AV signals Selector 4 SVHS in > 2 out
Video Input SYNC +0.30Vpp, 75Ω
Audio Input Stereo (R+L), 40KΩ
Video Output 1 Vpp ; 75Ω
Audio Output Stereo (R+L), 40KΩ
Audio Input terminals video 10 RCA jacks
Audio Distortion < 0.6dB (+/- 3dB)
Power Supply 12Vdc @300mA
Power Consumption 125mA
Accessories AV cable M-M 3 x RCA

Channel Separation > 50dB
Noise Reduction > 50dBVideo
Bandwidth 5 MHz
Audio Bandwidth 2-Hz-20KHz
Power Consumption 100mA~120mA
Video Distortion video < 1.2dB (+/- 3dB)
Dimensions Length 5.1" x Width 7.9" x
Height 1.6"
Weight 845 gm



Front View



Rear View

40-813 pAssiVe 4 iNpUt sVhs & CoMposit e

ViDeo, st eReo AUDIo sWit CheR

Used to switch 4 SVHS, composite video and L+R audio input signals to 1 output. Allows you to switch between DVD, VCR, camcorder, or any other Composite-SVHS, Stereo Analog Audio-Video device.

specifications:

Composite Video

Video level 1Vpp +/- 10%
Input impedance 75Ω
Through loss < 5%
Color dark gray
Video connector: Female RCA jacks with yellow inserts

Audio

Signal distortion audio< 0.6dB
(standard ± 3dB)
Audio input level 0-1Vpp, 10Hz-20KHz
Audio impedance 10k Min
Audio connectors Female Red & White RCA jacks

sVhs (Y/C)

Y, luminance input level 1Vpp +/- 10%
Input impedance 75Ω
Through loss < 5%
C, chrominance input level 1Vpp +/- 10%
Size: Length 7.75" x Width 4.5" x Height 1.75"

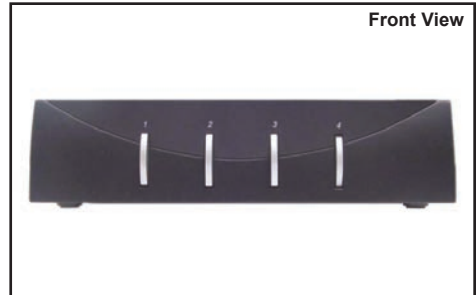

Front View



Rear View

CALRAD

40 series - ip Video products

40-CDL-160et h et heRNet AND UsB t o hDmi CoNVeRt eR

The Ethernet and USB to HDMI Converter allows you to use a TV as your laptop/desktops primary display. Simply connect the TV to the device and then plug the device into the Ethernet network and your TV will instantly become the PC's principal display. This Converter also has two USB ports, for a mouse and keyboard, allowing you to control any networked computer. Aside from enabling a TV to be your primary PC display this device also removes the problem of running expensive audio and video cabling over long distances, all that is needed is an Ethernet network. Because everyone can access a TV, they gain the ability to use a computer without being physically connected to it, so they can perform PC tasks like browsing the internet, use Microsoft Office and access any music or movies you may have on iTunes, a truly easy and cost effective solution for sharing AV among computers. Includes software disc and 5 Vdc power supply. Works with windows 2K SP4, windows XPhome or professional32 bit, windows vista 32 bit.

Applications:

Ethernet to HDMI Displays, USB to HDMI Display, Long distance PC display and control, PC application sharing, Docking stations, Projectors.

Features:

Experience the complete PC environment on a TV from 100 meters away. Content on the original PC monitor can be different from the TV content.

Allows a TV to act as the primary PC display, and when using a keyboard and mouse this allows you to browse the internet, use Microsoft Office and watch and listen to music/movies, from any networked computer.

Extend or mirror video through network or USB cable to HDMI display, including both video and audio output signals.

Share HDMI displays with multiple users through your existing office or home IP network.

Add an HDMI display to your computer through a USB 2.0 port. Supports mirror and extended video modes.

specifications:

Input Ports: 1 x Mini USB, Ethernet

Output Port: 1 x HDMI

Extender Ports: 2 x USB

Power Supply: 5VDC/2.6A (US/EU standards, CE/FCC/UL certified)

Size: Length 4.5" x Width 3.6" x Height 1.2"

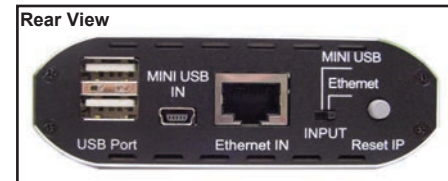

example 1A Connection and installation

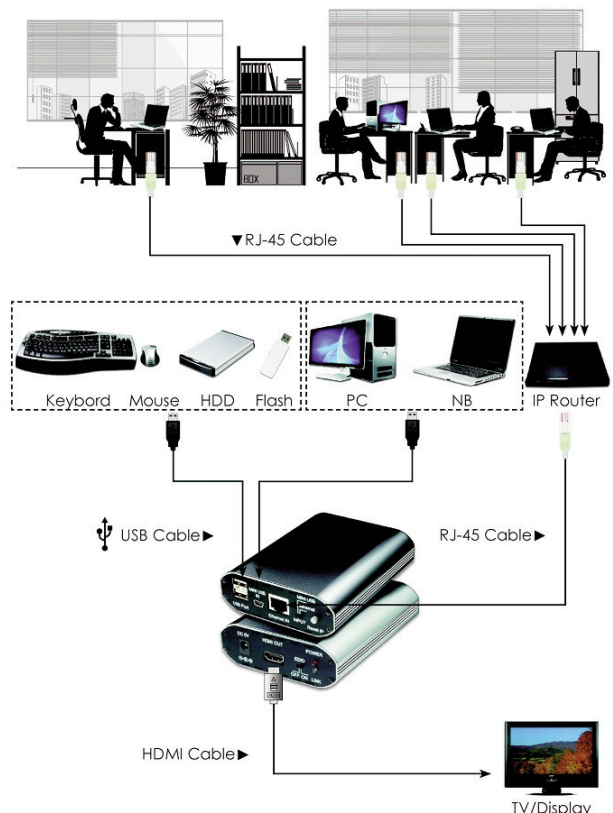

40 series - Audio-Video/speaker selectors/Audio Converters

40-851VC siX CHANNeL AUt oFoRmeR BAseD st eReo speAkeR seLeCt oR Wit h VoLUme CoNt RoLs

Rating per channel 100W, RMS continuous selectable A/B amplifier input. Multiple-position volume control: 10 position switch - max attenuation 42dB heavy duty. Push type connectors accept up to 12 awg. cable. Independent channel grounds for safe connection to all amplifiers (including bridged or floating ground). Load impedance resistors for amplifier protection. Size: 17"(W) x 3"(H) x 8"(D) front to back including knobs and terminal. Weight 12.5 lbs.



Size: 17"W x 3.0"H x 8"D

40-644 st eReo 2 WAY AUDIo iNpUt seLeCt oR (A+B)

Enables 2 audio inputs to be switched to 1 output. Slim metal chassis with black finish. Mounts with velcro, included or double stick tape. 2 L+R inputs, Female RCA jacks. Output cable with L+R Male RCA plugs, 5' long.



Size: 3"W x 1"H x 2.9"D

40-647 FoUR posit ioN st eReo speAkeR sWit Ch

Designed to switch 4 pairs of stereo speakers from 1 amplifier. Heavy duty rocker switches. Push-style terminals accept up to 14 gauge cable. Black steel cabinet with white labeling. Rated at 120 watts.

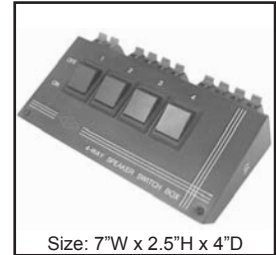

Size: 7"W x 2.5"H x 4"D

40-648 FiVe posit ioN RCA AUDIo st eReo sWit CheR

5 inputs to 1 output device. When more audio inputs are needed for a receiver/amplifier, provides switching for CD players, tape decks, tuners, VCR's, etc. Black steel cabinet with white labeling.



Size: 7"W x 2.5"H x 4"D

40-649 t hRee posit ioN RCA ViDeo/st eReo AUDIo sWit CheR

3 position rotary switch selects between 3 audio/video input signals and sends them to 1 output device. Black steel cabinet with white labeling.



Size: 7"W x 2.5"H x 4"D

40-DCT -1 Dig it AL t o ANALog CoNVeRt eR (LpCm) LiNeAR pULse CoDe moDULAt ioN

The 40-DCT-1 converts a digital audio signal source from a digital coax RCA jack or optical toslink jack and converts it to an analog stereo audio signal L+R RCA output jacks. It also includes a digital coaxial (SPDIF) "loopout" RCA jack, which is ideal if you need to send a single digital audio signal to both a digital and an analog device at the same time. Inputs: Coaxial and Optical digital audio ports. Outputs: Right and Left RCA-type Stereo analog output jacks. Digital audio format: Two Channel Linear Pulse Code Modulation (LPCM) Frequency response : 44.1 – 192KHz Sample rate. 24-bit incoming bitstream on left and right channels. DC Power Supply:12V DC Included. Size: Length 3.1" x Width 2.5" x Height 1".

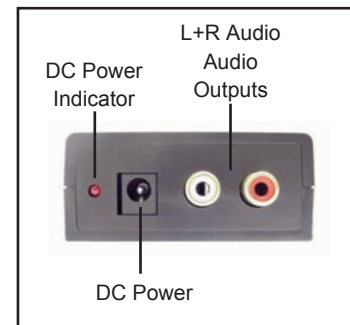
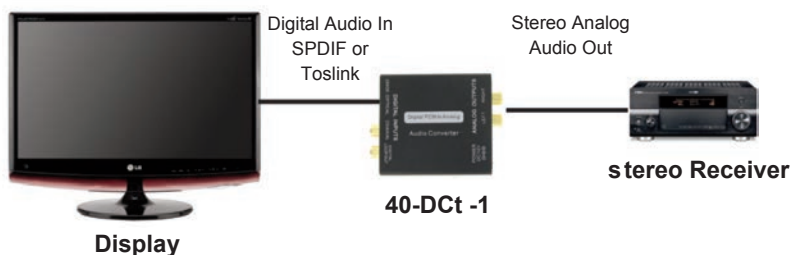
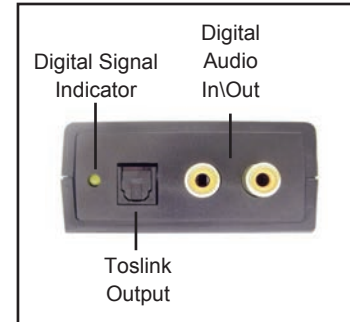
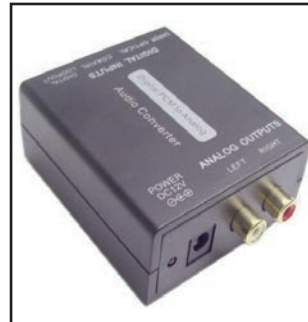

CALRAD

40 series - Analog/Digital Audio Converters

40-DCT-4 ANALog st eReo t o Dig it AL Co NVeRt eR (LpCm) LiNeAR pULSe CoDe moDULAt ioN

The 40-DCT-4 converts analog audio signal source to a digital coax jack or optical toslink jack and converts it to a PCM digital audio signal, coax, toslink output jacks. Inputs: RCA L+R audio jacks. Outputs: RCA coax jack, optical toslink jacks. Input audio impedance: 47K, Digital audio output format: Two Channel Linear Pulse Code Modulation (LPCM) Frequency response : 48/96Khz Sample rate. DC Power Supply: 12V DC Included. Size: Length 3.1" x Width 2.5" x Height 1".

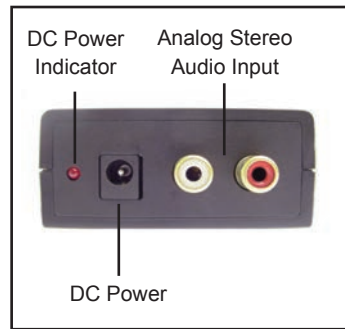
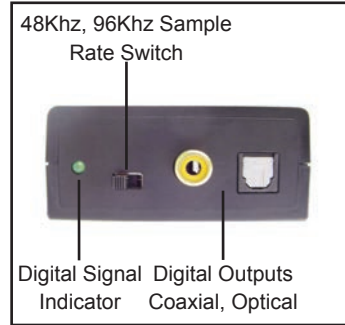

40-DCT-2 2 WAY Dig it AL AUDio Co NVeRt eR, RePeAt eR (spDiF t o t osLiNK, t osLiNK t o spDiF)

Coaxial / Toslink audio converter, its compact size and convenient features provides simple solutions for interfacing digital audio gear. It accepts S/PDIF audio signal input through either coaxial cable or toslink cable, and passes the signal (as is) to both its coaxial and toslink output ports. With its built-in amplification feature the 40-DCT-2 can also serve as a signal repeater and extend (double) the transferring distance. The 40-DCT-2 Cross-converts digital audio signals between "Toslink" optical and coax-electrical SPDIF formats transparently converting in either direction, and handling PCM (stereo) and bitstream (Dolby Digital, DTS) signals. Supports two-way conversion: coaxial to toslink or toslink to coaxial. Size: Length 1.75" x Width 1.75" x Height 1".

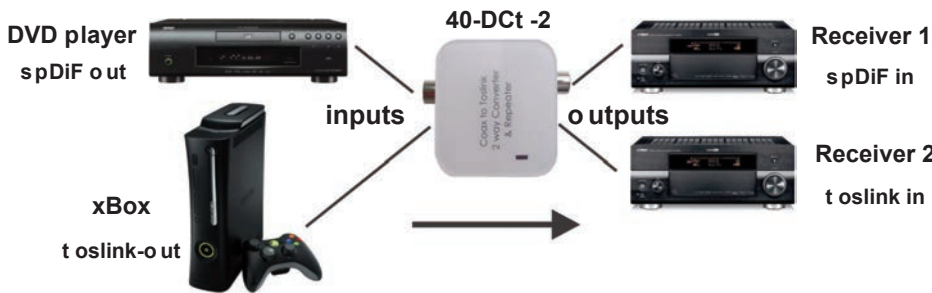

40-DCT-9 UNIVeRsAL Dig it AL \ ANALog AUDio Co NVeRt eR

The 40-DCT-9 is a comprehensive audio converter that provides a wide variety of audio formats/interfaces for users to take advantage of. With three different types of bidirectional connectors namely optical, coaxial and L/R, the DCT-9 can convert all three signals into any preferred format. Analog audio signal input can be converted into digital output, and digital audio signal into analog output. L.E.D. Indicators show what signal type is selected. The conversion process can be done simultaneously without any signal loss or delay. Supports sampling frequencies from 16 - 100 kHz. Size: Length 3.6" x Width 3.6" x Height 1.45".



CALRAD

40 series - Converters/Baluns

40-CW01A Designer style Composite Video + stereo Audio Wallplate Balun

Composite video and stereo audio over Cat5e extender on a designer style insert. Passive balun wall plate allows you to send composite video and stereo audio up to 1000 feet over a single Cat5e UTP cable. No power required. Dimensions: 11.5mm X 71mm. Sold in pairs.

1 x RJ45 Jacks



40-VW01

VGA over Cat5e extender on a designer style insert. Passive balun wall plate allows you to send VGA up to 300 feet over a single Cat5e UTP cable. Supports resolutions up to 1280 X 1024 No power required. Dimensions: 11.5mm X 71mm. Sold in pairs.

1 x RJ45 Jacks



40-DA01 Balanced passive signal Converter

40-DA02 Balanced passive signal Converter with 4" wire pigtail

Passive bi-directional signal design using UTP Cat5e or Cat6 cable pair. Use for Audio\Video\Component\IR signals.

Cable Distance:

Analog Audio, 1000 ft. Digital Audio, 300 ft. IR Signals, 300 ft. Composite video, 1000 ft., High Definition 480P - 300 ft., 720P - 200 ft., 1080i -100 ft., 1080P - 50 ft.

Wire termination

40-DA01: 2 Conductor captive screw terminals

40-DA02: 2 conductor locking style punch down blocks for easy wire

specifications

Bandwidth: DC to 50Mhz, DC passive

Connectors: RCA Male Plug

Signal Types: Analog+Digital Audio \ Video \ IR Signals

Housing Material: Plastic, Color: Black

Dimensions: 1.76"(L) x .68"(W) x .68"(H)

Dimensions: L 1.32" x W 0.6" x H 0.6"

40-DA01 Male RCA Plug spacing .64 inch center to center

40-DA01



40-DA01



40-DA02



40-DA02



Small Slotted Screw Driver Required



95-1041 ViDeo BALUN Cat -5 CABLE sYst em

Balanced video RJ45 to unbalanced Male BNC adapter. Transmit a composite video signal up to 1000' using industry CAT-5 networking cables with RJ45 connectors. Includes CAT 5 RJ45 Male to 2 screw terminal adapter. The advantages of this type of system are clear video signal, fewer cables to manage, lower cost per connection, centralized wiring for greater control. Video bandwidth 12MHz. Two units required for transmission and reception of balanced signals Size: Width .76" x Height .9" x Depth 2".

1 x RJ45 Jacks



Small Slotted Screw Driver Required



95-1046 Composite Video, s-Video, Analog or Digital Audio Balun

This passive RCA Audio/Video balun is ideal for corporate A/V, schools or home theater applications. Transmit stereo audio, digital audio, composite video or S-Video over A single Cat 5/Cat 6 UTP cable up to 1000 feet. Transmission of S-Video requires the Calrad 55-741 S-video Y adapter cable sold separately.

specifications:

RCA input Connectors: Gold plated RCA jacks X 2

RJ45 Connector : Female RJ45 jack X 1

Signal Input: Stereo Audio, Digital Audio, Composite Video, S-Video

Cable Transmission Distance: Stereo audio 2500 Feet max, Digital audio 1000 feet max

Dimensions: Length: 2.4" X Width: 1.69" X Height .865"

1 x RJ45 Jacks



CALRAD

40 series - k m, k Vm / Us B Baluns

40-km01 pC ps2 moUse AND keYBoARD oVeR CAT 5e \ CAT 6 BALUN

The 40-KM01 PS 2 mouse and keyboard balun system provides a low cost solution for extending the transmission signals of the mouse and keyboard over Cat5e or Cat 6 UTP cable up to 300 feet. Passive design requires no power. Ideal for corporate conference rooms and schools. Receiver dimensions: L- 2.6" x W-1.7" x H-1", transmitter dimensions: L x 2" x W- .96" x H-.82", Color: Black. Sold in pairs.

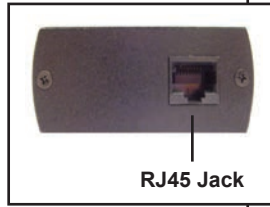

Rear View

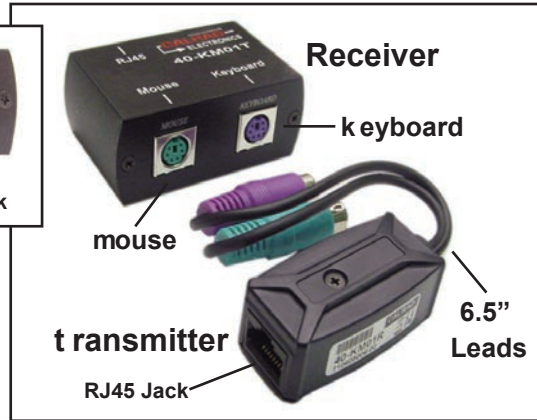

40-Vk m01 pC Vg A ps2 mo Use AND keYBoARD oVeR CAT 5e \ CAT 6 BALUN

The 40-VKM01 VGA, PS 2 mouse and keyboard balun system provides a low cost solution for extending the transmission signals of the VGA output, mouse and keyboard over Cat5e or Cat 6 UTP cable up to 300 feet. Passive design requires no power. Includes 9" VGA, PS2 keyboard and mouse cables. Ideal for corporate conference rooms and schools. Dimensions: Length 2.52" x Width 4.25" x Height 1.07". Chassis material ABS plastic, Color: Black. Sold in pairs.

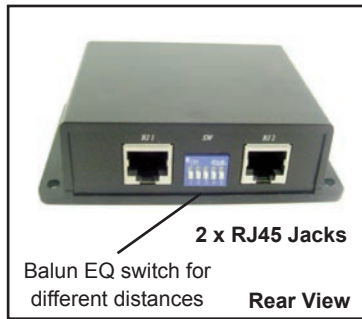

2 x RJ45 Jacks

Balun EQ switch for different distances

Rear View

Video Resolutions:
 800 x 600 at 105 Meters
 1024 x 768 at 75 Meters
 1280 1024 at 60 meters

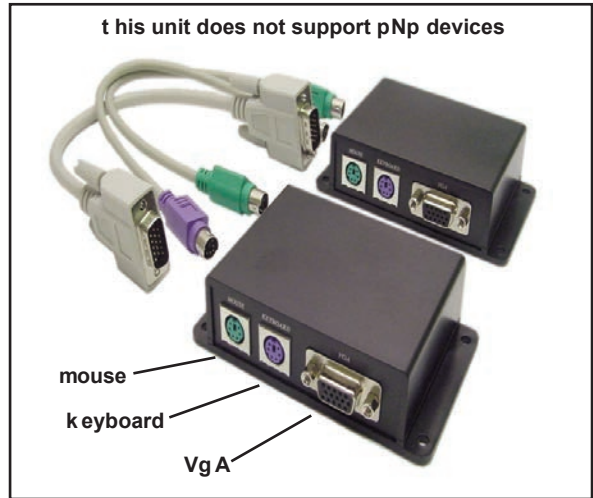

This unit does not support pNp devices

40-Ue04h UsB 1.1 CAT 5e eXt eNDeR \ BALUN Wit h 4 poRt UsB hUB

Extend 4 USB devices up to 50 meters over CAT5/5e cable. USB 1.1 compliant. Including local and remote unit. Compact size, easy plug and play. USB powered Transmitter, 5Vdc power supply for receiver included. Size: Receiver, Length 3.5" x Width 2.5" x Height 1.1", Transmitter, Length 2" x Width .75" x Height .6".



RJ45 Jack

Transmitter

Receiver

4 x Type 'A' USB Ports

40-Ue02 UsB 2.0 CAT 5e eXt eNDeR \ BALUN Wit h 4 poRt UsB 2.0 hUB

USB 2.0 extender can extend 4 USB 2.0 devices up to 150 meters from the location of your computer over CAT5/5e/6 UTP cable. It is optimized for applications such as digital signage, home network integration, industrial control, security, USB device sharing and KVM extension. Power + transmitter, receiver link L.E.D's.

specifications

Transmitter supports USB 2.0 high speed and USB 1.1 devices. Receiver supports 4 x USB 2.0 high-speed and USB 1.1 devices, data bit rate 1.5Mb/s, 12Mb/s, 480Mb/s. 5Vdc external power supply for the transmitter included. Plug and play for easy operation. Size: Transmitter, Length 6.7" x Width 3.3" x Height 1.3". Receiver Length 5.5" x Width 3.3" x Height 1.3".

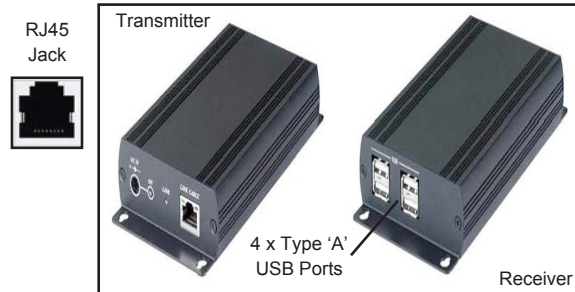

RJ45 Jack

Transmitter

Receiver

4 x Type 'A' USB Ports

40 series DVi \ hDmi Amplifiers & splitters

40-1030 hDCp Com plIAnT DVi AmpLiFieR CAsCADe UNIt s AND DeLiVeR sigNAlS Up t o 150 Ft . WoRks Wit h pC oR hDt V DeViCes

specifications:

Input/Output Connectors.....DVI Female Jacks Rear and Front
 Bandwidth..HDCP..... Compliant, 480i, 480P, 720P, 1080i (25 - 165 Mhz)
 Maximum Resolution..... 1600 X 1200 at 60 Hz
 Distance. (Using High Quality Cables) Total 100 -120 ft.Cascade to 150 ft.
 AC Power Supply/Connector.....9VDC 600 mA with 2.1mm coax jack
 Dimensions/Color.....4 1/8"W X 3" D X 1 1/8" H Silver Color
 Please note! Not all manufacturers are consistent with the specifications issued by the DDWG DVI 1.0 standard. Some equipment may not be able to achieve distances of 150 ft. Shorter length may be required, reducing the ability of the Calrad 40-1030 unit to reach longer distances. It is recommended to test the amplifier and cables prior to installation.



40-1060-2 hDt V 2 poRt DVi \ hDmi spLit t eR

HDCP Compliant. 1 DVI input to 2 HDCP DVI Compliant outputs. Supports HDTV 480P, 720P and 1080i. The DVI Splitter will ONLY pass DVI-D (DVI Digital) or HDMI Video Signals. PC up to UXGA (25-165MHz) Use Calrad 35 Series adaptes for HDMI signals. (Video only)

specifications:

Frequency Bandwidth:1.65 GHz
 DC Power:..... 7.5VDC, 1500 mA (included)
 Supported HD Graphic Resolutions:.....480P, 720P and 1080I
 Supported PC Resolutions VGA, SVGA, SXGA, UXGA(1600 X 1200)60Hz
 Connectors:..... 3 Female DVI jacks 24 + 5 pin
 Dimensions:..... Length: 6.0", Width: 3.0", Height: 1.6"
 Weight..... 1 lb

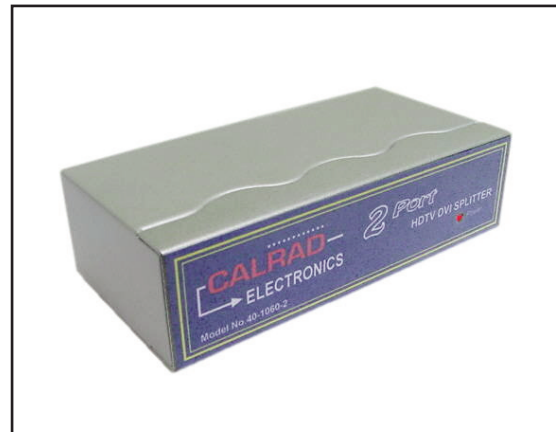

40-1060-4 pC \ hDt V 4 poRt DVi \ hDmi spLit t eR

Compact 1 RU size metal case, includes 19" rack mount ears. DVI Connectors, 1 input to 4 HDCP DVI 1.0 Compliant outputs. Cascadeable design for connecting multiple units.

Supports HDTV 480P,720P and 1080i. The DVI Splitter will ONLY pass DVI-D (DVI Digital) or HDMI type video signals. PC UXGA (25 - 165MHz)
 Use Calrad 35 series adapters for HDMI signals. (Video only)

specifications:

Frequency Bandwidth:1.65 GHz
 DC Power:7.5VDC, 1.5 Amps
 Supported HD Graphic Resolutions:.....480P, 720P, 1080I
 Supported PC Resolutions: VGA, SVGA, SXGA, UXGA(1600 X 1200) 60Hz
 Connectors:5 Female 24+5 pin DVI Female Jacks
 Dimensions..... Depth: 6.0", Width: 10.5", Height: 1.6"
 Weight.....1 lb

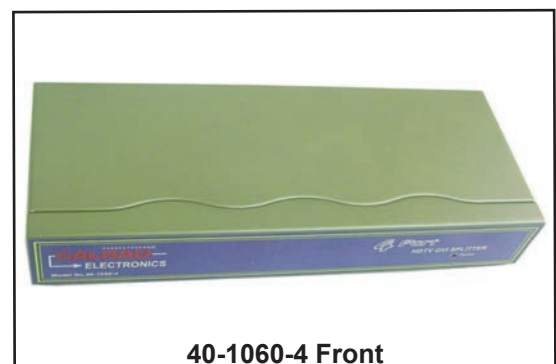

40-1060-4 Front



40-1060-4 Rear

CALRAD

40 series - DVi Converters

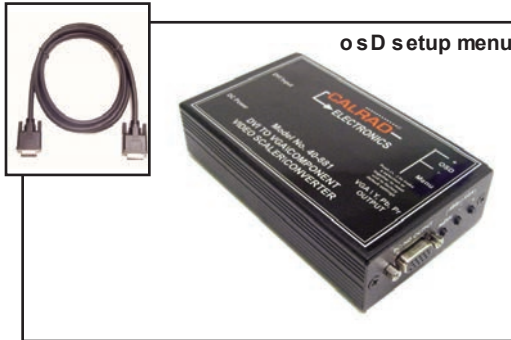

40-881 DVI-D to VgA CoNVeRt eR \ sCALeR

The 40-881 is a Digital DVI-D to analog VGA converter and scaler. DVI-D input to HDB15 VGA output. Input resolution is automatically detected while the output resolution and refresh rate can be selected via the OSD menu. The 40-881 has non-volatile memory and memorizes all your settings before the power is turned off and recalls those settings the next time the power is turned on. Supports 480P, 720P and 1080i input resolutions and will output 640X480, 800X600, 1024X768, and 1280X1024 PC resolutions. DVI-D cable and 5Vdc power supply included. Size: Length 5.25" x Width 3" x Height 1.25".



40-882 CoMpo NeNt , s-ViDeo , CoMposit e ViDeo to DVI CoNVeRt eR \ sCALeR

The 40-882 is a composite video and S-Video to DVI converter/scaler. Composite video and S-Video inputs are converted and scaled up to PC or HDTV resolutions. All settings are modifiable through the OSD menu. Supports NTSC 3.58, NTSC 4.43. Pal-M, Pal-N and Secam formats. Output resolutions for PC are 640X480, 800X600, 1024X768 and 1280X1024. HDTV resolutions are 480P, 720P and 1080i. 5Vdc power supply included. Includes 6 ft. DVI M-M, 3 ft. S-Video M-M, 3 ft. Composite video M-M, 6" pigtail component video adapter. Size: Length 5.75" x Width 3" x Height 1.25".



40-883 DVI-hDmi ViDeo pAt t eR N g e N e R a t o R

The 40-883 DVI test pattern generator provides over 20 of the most-often-used test patterns for calibration, testing and troubleshooting DVI-D or DVI-I signals. It is ideal for use with LCD monitors, PC monitors or projectors that are equipped with DVI-I or DVI-D inputs. Easy to use OSD menu allows you to select a variety of test patterns. Grey scale and multiburst. Requires 35-711A DVI to HDMI adapter sold separately. 5Vdc power supply included. Size: Length 5.75" x Width 3" x Height 1.25".



35-711A
HDMI Female to DVI-Male Adapter with Gold plated contacts.



40-886 VgA to DVI-D CoNVeRt eR \ sCALeR

The Calrad 40-886 converts VGA or Y, Pb, Pr component video to DVI-D. can interface between analog VGA and digital DVI-D signals while scaling up or down. The default DVI output resolution is set for 1024 X 768. A backup memory system saves and recalls the previous settings when power is removed and reapplied. 5Vdc power supply included. Includes 3ft. DVI, composite video, component video dongle cables. Size: Length 5.75" x Width 3" x Height 1.25".

specifications:

input/output resolutions

VGA 640 x 480	1080i ,1920 x 1080	Weight: 10 oz, Dimensions: 1.2" x 3" x 5.5" Power Source 5 Volt DC
VGA 800 x 600	720P,1280 x 720	
XGA 1024 x 768	576P, 720 x 480	
Mac 1152x 864	480P, 640 x 480	
WXGA 1280 x 768	480i, 720 x 480	
SXGA 1280 x 1024		

28-35 series - DVi/hDmi Adapters

28-163p

DVi-i to DVi-i Feed-thRU

White plastic designer style insert plate with one DVi-I Female to Female feedthru. Nickel plated. Includes mounting hardware. Color is white. Interior depth 0.4 inches

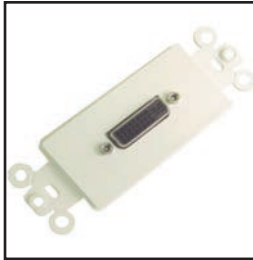

28-163-pC

White plastic insert plate with DVi Female jacks on both sides. Jacks are mounted on offset circuit board for a low profile front and back. Gold plated connectors insure excellent contact and long life. Red L.E.D. 5V signal indicator. Overall depth 1" front to back.

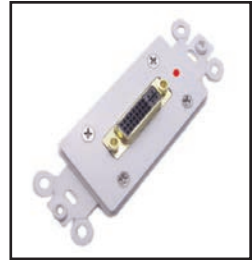

28-164-m

28-164m-2

Single or Dual DVi-I feed thru

DVi-i Feed-thRU

Stainless Steel full sized wall plate with a single or dual DVi-I Female to Female feed-thru.



DVi-i pinout

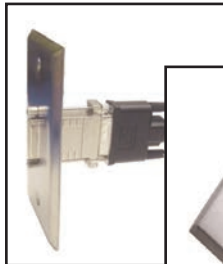

hDt V

35-600

HD-DB15 "Y" shielded low loss cable. Male HD-DB15 SVGA connector to 2 Female HD-DB15 SVGA connectors. Used to drive 2 monitors from A single graphics card.



DVi-I Male
VGA Female
DVi-D Male

35-601

DVi-I to DVi-D & VGA Splitter. Separates DVi-I Male to DVi-D Female and VGA Female. For use with DVi-I ports that share analog + digital signals.



35-700

DVi-I Male to VGA DB-15 Female Adapter. Allows you to connect VGA display to a DVi-I graphics card. **Not e**, this adapter does not provide a digital to analog signal conversion. It will not work with DVi-D.



35-701

DVi-A Male to VGA DB-15 Female Adapter. This adapter allows you to connect a DVi-A display to a VGA graphics card.



35-702

DVi-D Female to DFP 20 Pin Male Adapter. **35-703** DVi-D Male to DFP 20 Pin Female Adapter.



35-710A

DVi-I to DVi-I Female to Female Coupler. Shielded di-cast case handles 5 pin analog and 24 pin digital signals. gold plated contact pins. Used for inline or chassis mount. Fits in standard DB15 d-sub cutout. Overall length .93" For wall mounting use Calrad p/n 30-598.



35-711A

HDMI Female to DVi-D Male Adapter with Gold plated contacts.



35-712A

HDMI Male to DVi-D Female Adapter with Gold plated contacts.



35-715

HDMI Female to DVi-D Male Cable Adapter with Gold plated contacts, 6" Length.

35-716

HDMI Male to DVi-D Female Cable Adapter with Gold plated contacts, 6" Length.



35-717

DVi-I Female to M1DA Male plug. Length 6" Gold plated contacts.



35-727

DVi-D Female to Male Display Port. Gold plated contacts.

CALRAD

40 series - hDmi Baluns, extenders

40-1072m hDmi 1.3, 3D eXt eNDeR oVeR tWo CAT 5e \ Cat 6 CABLEs

Compact HDMI extender is designed to deliver HDMI 1.3 signal sources over 2x Cat 5e or Cat 6 UTP cables that can deliver HDTV signals to plasma, LCD and projection displays. All metal case with ear mounts. These devices are a perfect solution for replacing costly standard HDMI cables that are difficult to route thru walls and cabinets. A small class 2 power supply is required on the receiver side. HDTV Resolutions: 480P, 720P, 1080i, 1080P (Max 10.2Gbps, HDMI 1.3), HDCP Compliant.

specifications:

Input TMDS Signal: 5Vpp, Input DDC 5Vpp
 HDMI female In\Out Connector Jacks, 2 x RJ45 Shielded Jacks
 DC Power Supply: 5V, 1A, Switch mode Regulated, 110-220Vac
 Dimensions: Transmitter: L-2.6" x W-1.69" x H-1.0", Receiver: L-2.4" x W-1.69" x H-1.0"
Cable Distance 1080Pat 100 ft., CAT6 Cable at 125 ft., 1080i at 200 ft.
 720P at 200 ft. 480P at 300 ft.



40-1070 hDmi 1.3, 3D eXt eNDeR oVeR siNg Le CAT 5e \ Cat 6 CABLE

Extends an HDMI signal over a single CAT5e or Cat6 cable. HDCP and HDMI 1.3 compliant. EQ rotary switch on the transmitter and receiver for HDMI or DVI mode and for LPCM 7.1 or stereo audio modes. Sold as a transmitter and receiver set. 5Vdc power supplies included.

specifications:

HDMI in/out 19 pin Female connectors
 2 RJ 45 shielded connectors
Cable Distance 1080P, 100 ft., CAT6 Cable 125 ft. 1080i, 200 ft.
 720P, 200 ft. 480P, 300 ft.
 Dimensions: L 3.25" X W 2.5" X H 1.1"



40-1090 hDmi 1.3B \ DVi eXt eNDeR\ViDeo BALUN oVeR siNg Le CAT 5e \ Cat 6 CABLE

HDTV Resolutions: 480P, 720P, 1080i, 1080P (1.65 Gbps, HDMI 1.3b)
 Input TMDS Signal: 5Vpp, Input DDC 5Vpp
 Vertical Frequency Range: 50/60Hz
 HDMI In\Out Connectors: 19 pin Female Jack, 1 Jack each unit
 RJ45 Shielded Connectors: 1 Jack, each unit, 2 x L.E.D power indicators
 DC Power Supply: 2 x 5V, 2A, Switchmode Regulated, 110-220Vac
 Dimensions: Length 3.9" x Width 2.57" x Height 1.1"

Cable Distance
 1080P, 150 ft. 1080i, 200 ft. 720P, 250 ft. 480P, 300 ft.



40-1093 hDmi 1.3B \ DVi 48Bit , 3D eXt eNDeR \ ViDeo BALUN oVeR siNg Le CAT 5e \ Cat 6 CABLE Wit h iR, Rs 232

40-1094 1.3B \ DVi 48Bit , 3D eXt eNDeR\ViDeo BALUN oVeR siNg Le CAT 5e \ Cat 6 CABLE

Extends an HDMI signal over a single CAT5e or Cat6 cable. HDCP and HDMI 1.3b compliant. HDMI or DVI mode, LPCM 7.1, True HD, DTS-HS or stereo audio modes. Sold as a transmitter and receiver set. 5Vdc power supplies included.

specifications:

Video Resolution 480P, 720P, 1080P
 Distance: 100 Meters
 HDMI In\Out Connectors
 RS232 Baud Rate: 115,200 bps / Full Duplex
 RS232 Connector: DB9 Female
 IR Carrier: 38Khz
 IR Receiver +/-10 degrees, 5 Meters
 DC Power Supply: 5Vdc, 2A
 Receiver-Transmitter Size: Length 5.125" x Width 3.5" x Height 1.25"
 Bi-Directional IR In\Output Jacks

40-1093-iRA optional iR Adapters

Use these 3.5mm Male to Female IR pigtail adapters to interface industry standard IR connecting blocks and IR emitters. Sold in pairs, 1 x transmitter, 1 x receiver.



100 meter hDmi Balun

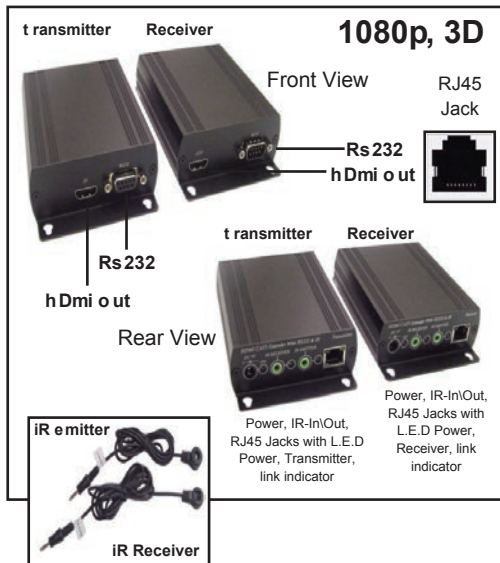

40 seRies - hDmi Converter-s calers

40-1096 2 input hDmi 1.3B, 1080p-3D oVeR A siNg Le Co AX CABLE eNCo DiNg -DeCo DiNg sYst em

Extend HDMI 1.3b, 1080P digital signals over a single RG59 or RG6 coax cable. Advanced chip technology enables HDMI to be delivered over new or existing coax cable available in most homes over long distances with IR control back to the source and to switch between HDMI inputs on the transmitter. Include 2 button IR remote, 5Vdc power supply.

specifications

Video amplifier Speed 10.2 Gbps (HDMI 1.3b)
 Video Amplifier Bandwidth:340Mhz, up to 12 bit YUV 444 Supported @ 1080p
 Power Supply: 5Vdc, 2A
 Size: Length 4.75" x Width 3.75" Height 1.2"



IR Remote



hDmi oVer a single Coax Cable

supports 3D

40-1095 hDmi 1.3B, 1080p-3D oVeR FiVe Co AX CABLEs eNCo DiNg -DeCo DiNg sYst em

Extend HDMI 1.3b digital signals over five 75Ω BNC or 'F' coaxial cables. Supports 480I, 480P, 720P, 1080I and 1080P resolutions. HDMI, HDCP and RoHS compliant. Use existing coaxial cables to extend a 1080P signal up to 300 ft. Includes the HDMI over coaxial transmitter, the HDMI over coaxial receiver and 5Vdc power supply.

specifications

Video Amplifier Bandwidth:3.4 GHz
 Video Amplifier Frequency:340 MHz
 Vertical Frequency Range: 50 - 85 Hz
 Input Connector: HDMI Female X 1
 Output Connectors: BNC Female X 5
 Power Supply : 5 Vdc
 Size: Length 4.29" X Width 2.48" x Height 1.18"

1080p Front View



hDmi oVer Five Coax Cables



75-679
"F" Female to BNC Male adapter.

40-255i mULt ipLe ViDeo sigNAl FoRmAt tO hDmi 1.2 Dig it AL ViDeo sCALeR pRoCessor

Upscale composite video, S-video, SVGA or component video to HDMI 1.2. Also convert digital or analog audio to HDMI 1.2 combined audio and video or digital coaxial SPDIF output. Comprehensive OSD menu allows the user to select a variety of settings and output resolutions. IR, RS232 or manual control. Supports 480P, 720P, 1080I and 1080P resolutions.

specifications

HDMI 1.2 HDCP compliant
 Supports 50/60Hz frame rate conversion
 Picture adjustments: Contrast, Brightness, Hue, Saturation, Sharpness, RGB levels and Aspect ratio. Inputs: Component Video, Composite Video, S-Video, SVGA and HDMI 1.2+ Aux analog audio for DVI adapter connectivity.
 Outputs: HDMI 1.2, RCA SPDIF.
 Includes one ea. of a 3 ft. VGA cable, 3 ft. component cable, 3 ft. composite, L+R cable and 5 Vdc power supply.
 Size: Length 8.375" x Width 6" x Height 1.25"



IR Remote

Front View



Rear View



Vg A Video Cable

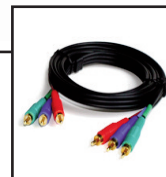

Component Video Cable



Composite Video Cable

CALRAD

40 series - Composite & Component Video, Vg A to hDmi Converters

40-720pHD Composite Video \s-Video to hDmi CoNVerT eR

The 40-720PHD converts composite video/s-video/stereo audio to HDMI. Accepts NTSC 3.58, Pal-M and Pal-N composite video and S-Video inputs as well as 3.5mm stereo audio and converts the signals to 720P HDMI with audio. Audio is incorporated into the HDMI output as well as the 3.5mm stereo output simultaneously. Video inputs auto detect video source. Selectable vertical rates of 50/60Hz. DVI-D compatible with Calrad adapter 35-712A. 5Vdc power supply included. Size: Length 5.75" x Width 3" x Height 1.25".

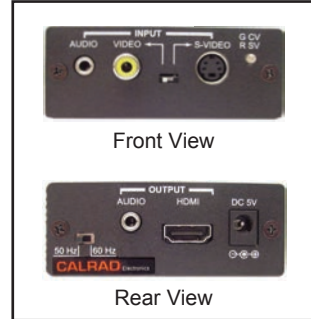

40-40Vh01 Vg A to hDmi CoNVerT eR Wit h Loop Out pUt s

The 40-40VH01 video converter provides a simple method to allow PC users to show their image not only on their PC's monitor but also on their HD television by converting VGA, RGB+HV into HDMI-HDTV. Selectable dip switches for 3.5mm stereo jack R/L audio or digital audio. Convert a VGA signal to HDMI. If the VGA source is set to 480i, 720P or 1080i, 1080P Then it will convert to HDMI at the same resolution. 1Ft. Male to Male VGA cable included. VGA, Analog and Digital audio pass-thru jacks.

specifications:

Input Signal: VGA (DB15 Jack), (3.5mm Jack) Analog Stereo Audio or (RCA Jack) Digital Audio

Output Signal Loop (VGA, Analog Stereo + Digital Audio)

Output Signal: HDMI 1.3, supports DVI format, adapter not included

Audio Input Impedance: Analog Audio - 10K, Digital Audio - 75 Ω

DC Power Coax Jack: 5Vdc, 500ma

Size: Length 3.75" x Width 4.75" x Height 1.25"



40-40Vh02 Vg A to hDmi CoNVerT eR

The 40-40VH02 Converts VGA, RGB+HV into an HDMI-HDTV format with stereo audio. The 3.5mm stereo jack provides R/L audio that mixes with the VGA video to be converted into HDMI video and audio. The 40-40VH02 converts the VGA signal to HDMI at the resolution of the VGA video source. If the VGA source is set to 480i, 720P or 1080i, 1080P, then it will convert to HDMI at the same corresponding resolution. Front panel power and signal L.E.Ds.

specifications:

Input Signal: VGA (HD-DB15 Jack), 1920 x 1080 max, (3.5mm Jack) Analog Stereo Audio

Output Signal: HDMI 1.3 HDCP compliant, supports DVI format, adapter not included

Audio Input Impedance: Analog Audio - 10KΩ

DC Power Coax Jack: 5Vdc, 500ma

Size: Length 2.75" x Width 4.25" x Height 1"



40-40Yh01 Component Video to hDmi CoNVerT eR

The 40-40YH01 video converter provides a simple method to convert component video and analog or digital audio to HDMI. Plug and Play design. The converter uses a selectable dip switch to select either stereo R/L audio or digital audio. If the component video source is set to 480i, 576i, 576P, 720P, 1080i, 1080P, then it will convert to HDMI at the same corresponding resolution. Component video, stereo analog and digital audio pass-thru jacks are provided for uninterrupted signal to a second display.

specifications:

Input Signal: Component Video (RCA Jacks Y, Pb, Pr), 1920 x 1080P max, Analog Stereo Audio or Digital Audio (RCA Jacks)

Output Signal Loop (Component Video, Analog Stereo + Digital Audio)

Output Signal: HDMI 1.3, supports DVI format, adapter not included

Video Amplifier Bandwidth: >140MHz

Audio Input Impedance: Analog Audio - 10K, Digital Audio - 75 Ohms

DC Power Coax Jack: 5Vdc, 500ma

Size: Length 3.75" x Width 4.75" x Height 1.25"



CALRAD

40 series - hDmi Amplifiers

40-1061-2, 1X2 hDmi 1.3, 3D Dist RiBUt io N AmpLiFieR

One input to two outputs HDMI 1.3 distribution amplifier. HDCP and HDMI 1.4a compliant. Supports HDTV resolutions of 108i and 1080P. 5Vdc power supply included. Length 3.4" X Width 1.85" X Height 1.0". Color: Black.



40-1061-4, 1X4 hDmi 1.3, 3D Dist RiBUt io N AmpLiFieR

One input to four outputs HDMI 1.3 distribution amplifier. HDCP and HDMI 1.4a compliant. Supports HDTV resolutions of 108i and 1080P. Front panel on/off power switch. Length 10.2" X Width 4.5" X Height 1.0". 5Vdc power supply included. Color: Black.



40-1061-8, 1X8 hDmi 1.3, 3D

Dist RiBUt io N AmpLiFieR

40-1061-16, 1X16 hDmi 1.3, 3D

Dist RiBUt io N AmpLiFieR

One input to eight outputs HDMI 1.3 distribution amplifier. HDCP and HDMI 1.4a compliant. Supports HDTV resolutions of 480P, 720P, 1080i and 1080P. 40-1061-8 size: Length 8.9" x Width 6.2" x Height 1.0". 5Vdc power supply included. Color: Black. 19" rack mounted design.



CALRAD

40 series - hDmi switchers

40-991, 2 iNpUt s t o 1 oUt pUt mANUAL hDmi sWit CheR

Two input to one output manual HDMI switcher with Locking push button switching. Passive operation does not require power. Supports 1080i and 1080P HDTV and 1600X1200 PC resolutions. Size: Length 5.25" X Width 4.5" X Height 1.25".



40-992-1.3 Co mpACt hDmi 1.3B 3 X 1 sWit CheR

3x1 compact HDMI 1.3 switcher routes high definition video and digital audio from any one of the three sources to a single video display unit. The 40-992-1.3 can be manually switched or controlled with the IR remote that is provided. Active operation, gets power from the HDMI sources or display. IR receiver Cable length: 3 ft. Dimensions: Length 3" x Width 1.8" x Height .55". Includes external remote IR receiver and IR remote control.



40-998-hs, 3D hDmi 1.4A, 3D 4 X 1 sWit CheR

4X1 HDMI 1.3b HDCPcompliant switcher. Manual/IR or RS232 control. Plug and play installation. Maintains input memory after power loss. LED signal selection indicators for inputs. Supports 480P, 720P, 1080I and 1080P resolutions. 5Vdc power supply and IR remote included.

specifications

IR distance: 30-35 feet
 Frequency bandwidth: 1.65 Gbps
 Connectors: Gold plated Female HDMI jacks X 5
 Power: 5Vdc, 2 Amp
 Dimensions: Length 9.5" x Width 4.1" x Height 2"



IR Remote



40-967m 4X2 1080p 3D 1.3B hDmi mAt RiX sWit CheR

4 HDMI Inputs to 2 HDMI Outputs HDMI matrix switcher. Supports HDTV resolutions of 480i, 576i, 480P, 576P, 1080i, 720P and 1080P, deep Color 24/36 Bit, 3D Support. Fully HDMI and HDCP compliant. Separate digital toslink and stereo audio outputs from HDMI/Out 1. The matrix switcher allows you to assign any of the 4 HDMI inputs to either of the 2 HDMI outputs from the manual push button controls or IR remote control. External IR receiver input jack for external IR receiver. Use optional IR interface cable to connect directly to IR connecting blocks. 12Vdc power supply, IR remote control included. Size Length 12.5" x Width 6.25" x Height 1.25".



40-967M-EII External IR Interface Cable



External IR Remote Receiver



IR Remote

CALRAD

40 series - hDmi switchers

40-968m-4 4X4 mAt RiX sWit CheR
40-968m-8 8x8 mAt RiX sWit CheR
sUpport s hDmi 1.4A, 1080p, 3D
 4, 8 HDMI Inputs to 4, 8 HDMI Outputs
 HDMI matrix switcher. Supports HDTV
 resolutions of 480i, 576i, 480P, 576P,
 1080i, 720P and 1080P 3D. Fully HDMI
 and HDCP compliant. The matrix switcher
 allows you to assign any of the HDMI
 inputs to any of the HDMI outputs through
 the manual push button controls or IR
 remote control. 12Vdc power supply, IR
 remote control included. 40-968M-4 Size:
 Length 19" x Width 8" x Height 1.75",
 40-968M-8 Size: Length 19" x Width 8" x
 Height 1.75". 40-IR-KIT sold separately.

supports 1080p 3D

FRoNt

19"
Rack ears



Front panel Buttons

iR Receiver, ext. iR Receiver port

iR emitter ports



Rs232 Control

ReAR

40-iR-kit



HDMI IR Dongle



IR Emitter



IR Receiver



IR Remote

19"
Rack ears



IR Ext. Receiver
Included



FRoNt

Front panel Buttons

iR Receiver, ext. iR Receiver port

iR emitter ports



Rs232 Control

ReAR



Displays

Use The optional HDMI IR Dongle, IR Emitter, IR Receiver
as a remote IR repeater system from any HDMI output port.

Application Diagram 8 sources to 8 Displays

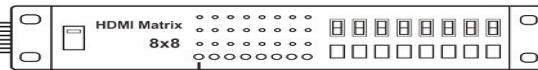

iR emitter

iR Receiver

40-iR-kit

hDmi iR Dongle

iR Remote

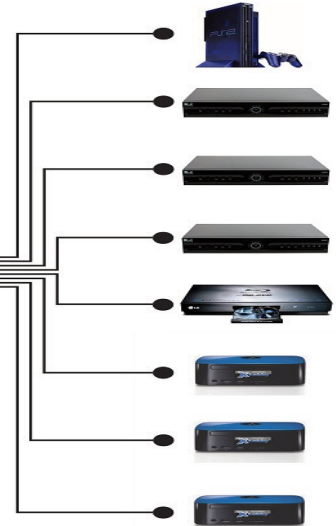

sources

Note: All specifications on this page are subject to change without notice

CALRÄD

40 series - Us B pC Video Adapter

40-40AN2420 DVI-D, hDmi t o UsB ADAPT eR

40-40AN2440 DVI-, hDmi t o UsB ADAPT eR (sUppo Rt s ViDeo Up t o 1680X1050)

This USB Display Adapter enables you to connect one more monitor, LCD or projector to a computer with a USB 2.0 port. For desktop users adding an extra monitor via USB connection is easier than ever without having to open the computer chassis to install an internal video card. Once the installation is done, the USB-attached monitor soon wakes up. No function key hassle to swap a second monitor.

With this handy adapter, you can enjoy many benefits brought by an add-on monitor. The most obvious one is that you get more desktop area to have more applications visible at one time. For example, you may work on one monitor while your family watch video on the other. No more stacking windows within the confines of a single display. Or you may span an application, e.g. spreadsheets, across two displays. What's more, the adapter is hot pluggable. If you are not using the extra monitor, just unplug the adapter at any time; no reboot needed.

specifications:

UsB: Ver 2.0

Video interface: DVI-I

Connectors: Video output: DVI-I 24pin + 5pin Female Connector

host upstream link: USB Mini-B Type Female Connector

Connectivity: Up to 2 adapters on a computer

RAm: 8M x 16 DDR Synchronous DRAM (SDRAM)

power mode: Bus-powered

operation system support: Windows 2000 SP4, XP SP2 and Vista 32-bit

supported modes: Extended Desktop (Default), Mirrored Desktop, Primary Display

supported Resolutions: 640x480, 800x600, 1024x768, 1280x960, 1280x1024, 1360x768, 1366x768, 1368x768, 1400x1050, 1440x900, 1600x1200, 1680x1050

housing: Plastic

Dimensions: 84.3 (L) x 54 (W) x17.8 (H) mm

UsB Cable separated from the body: Type: USB A -Type Male to 5pin Mini USB B-Type Male

Color: Black

Length: 1M

operating temperature: 10-40°C

Relative humidity: < 85% non-condensing

EMC FCC Part 15 Class B, IC ICES-003 CE (EN55022, EN61000, EN55024)

Rohs: RoHS compliant



package Contents

USB Display Adapter x1

Driver CD x1

USB Cable x1

Quick Installation Guide x1

DVI-A male to VGA female Adapter x 1

35-700 DVI-i male to Vg A DB-15 Female Adapter

Allows you to connect VGA display to a DVI-I graphics card. Note, this adapter does not provide a digital to analog signal conversion. It will not work with DVI-D, Included.



Desktop PC,
Laptop

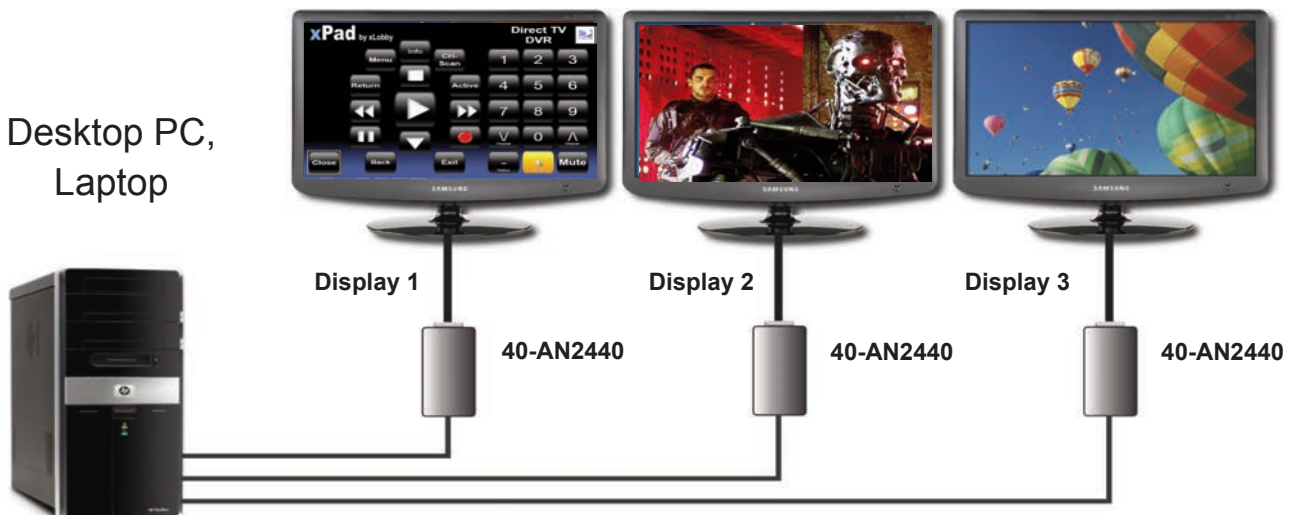

40 series - passive A/V hum eliminators



Typically 60Hz black or dark to light bars can be seen as slowly vertically moving horizontal bars in normal TV video signals, this normally caused by different ground path potentials. Calrads Hum Eliminator products remove 60Hz hum bars from your video and audio signals to provide an interference free installation.

40-970 Component Video Hum Eliminator

HDTV component video hum eliminator. Supports 480P, 720P, 1080i and 1080P resolutions. 75 ohm impedance. 200MHz video bandwidth. RCA input and output jacks. Dimensions: Length 8.7" X Width 4.1" X Height 2.1". Chassis color: Black.



40-973 Composite Video AND Stereo Audio Hum Eliminator

Composite video and stereo audio hum eliminator. 75 ohm impedance. 200MHz video bandwidth. Audio bandwidth 200-15Khz. RCA input and output jacks. Dimensions Length 8.7" X Width 4.1" X Height 2.1". Chassis color: Black.



40-975 Single Channel SDI Digital Video Hum Eliminator

Single channel SDI digital video hum eliminator. 75 ohm impedance 1.5Gb/sec data rate BNC input and output jacks. Dimensions Length 4.68" X Width 3.68" X Height 2.0". Chassis color: Black.

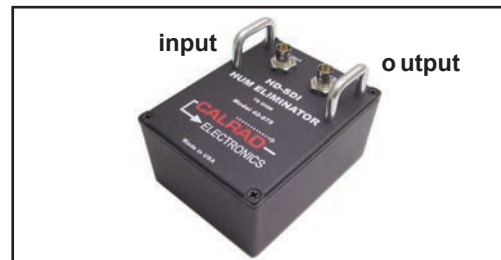

40-977 4 Channel SDI Digital Video Hum Eliminator

4 channel SDI digital video hum eliminator. 75 ohm impedance 1.5Gb/sec data rate BNC input and output jacks. Dimensions: Length 7.40" X Width 4.70" X Height 3.2". Chassis color: Black.

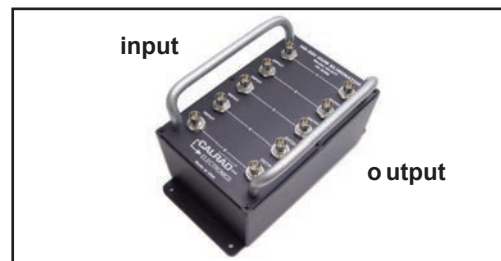

40-979 CATV Digital Hum Eliminator

CATV digital hum eliminator. DC passive design. Low VSWR prevents signal loss. 75 ohm impedance. 2Ghz video bandwidth. RF-81 input and output jacks. Dimensions: Length 6" X Width 4.7" X Height 3.75". Chassis color: Black.

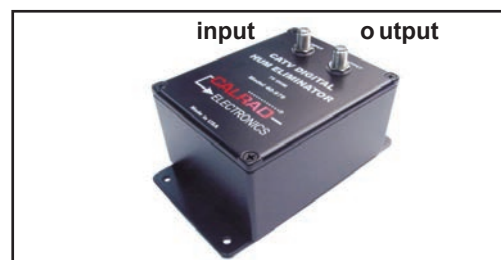

CALRAD

40 series - VgA Baluns, extenders

40-1010 VgA oVeR siNg Le CAT 5e eXt eNDer

The 40-1010 allows you to transmit a VGA signal up to 580 ft. over Cat 5e. Supports PC resolutions up to 1280X1024. HDDB 15 Female input and output. The receiver has built-in active equalization circuitry providing adjustments of Gain/EQ levels for different lengths of cable. The transmitter and receiver requires individual power. 12Vdc power supplies, included. Sold in pairs, Transmitter, Receiver Size: Length 3.76" x Width 1.3" x Height 1.2".

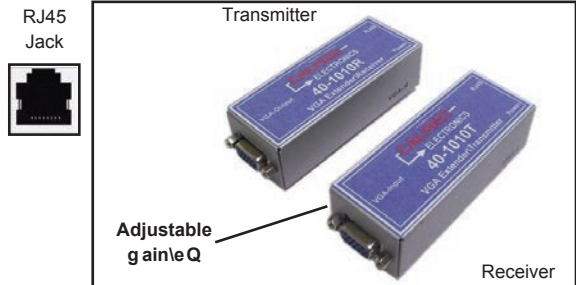

40-7110 VgA \ CoMpoNeNt ViDeo oVeR siNg Le CAT 5e eXt eNDer tRANsmit tER AND ReCeiveR

Calrad's high-resolution baluns for VGA or Component video over Cat5e/Cat6 can extend stereo audio and video signals up to 1,000 feet using a single Cat5e or Cat6 cable. The receiver has built-in active equalization circuitry providing adjustments of Gain/Peak levels for different lengths of cable. This technology is a perfect and reliable solution for situations where your VGA/HDTV monitor needs to be located in a separate location from where the VGA/HDTV source is located. Cat6 UTP cables can be used but may cause skewing of signal pairs at certain resolutions. This balun does not do any video transcoding only the same signal type in/out. Sold in pairs. 5Vdc external power supply included. Audio video adapter cables required for component video, sold separately. Video Delivery: VGA 1000 ft., 480P 900 ft., 720P 700 ft., XGA 600 ft., 1080i 500 ft., SXGA 450 ft., 1080P 250 ft. . Size: Transmitter Length 4.25" x Width 2.6" x Height 1.1", Receiver Length 3.5" x Width 1.75" x Height .9".

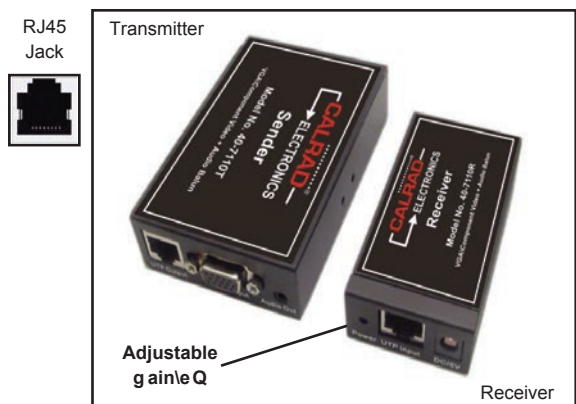

40-6220 (tRANsmit tER & ReCeiveR), 40-6220R (ReCeiveR oNLY, soLD sePeRAt eLY) ACt iVe VgA \ CoMpoNeNt ViDeo oVeR CAT 5e eXt eNDer, tRANsmit tER AND ReCeiveR VgA+RJ45 Loop oUt pUt s)

Transmit VGA and 3.5 stereo audio up to 1000 ft over a single Cat 5e or Cat 6 cable. Can also be used for component video and audio. 1ft 3.5mm plug to dual RCA adapter cable and 1ft. HDDB15 Male to 3 RCA Male Y, Pb, Pr, 1 ft. 3.5mm to stereo RCA audio adapter cables included. The receiver has a RJ45 loop out jack to daisy chain more receivers and the transmitter has a VGA + stereo audio loop out for a local monitor. Adjustable video gain and EQ controls. Includes 2 x 5Vdc, 2A power supplies. See example 1A for typical hookup.

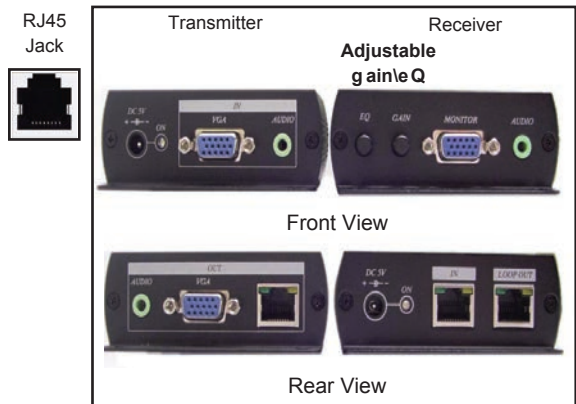

example 1A.

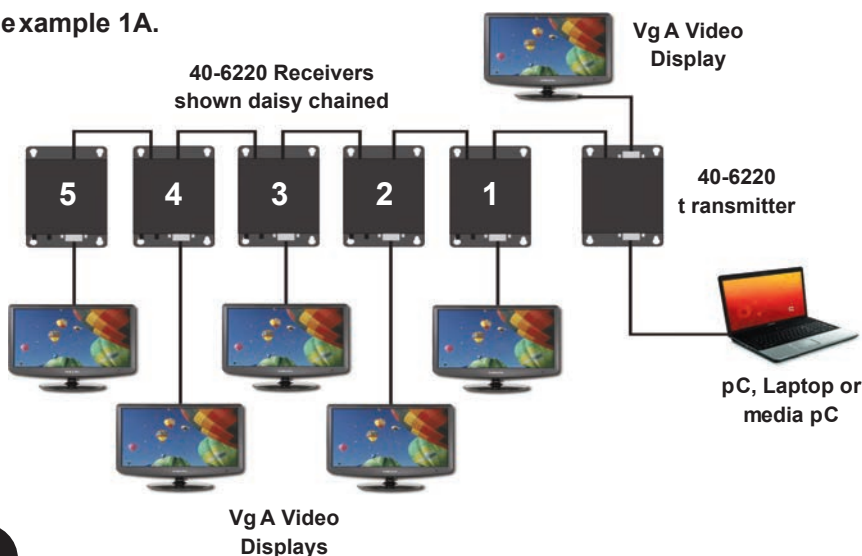

CALRAD

40 series - Vg A Coverters

40-888 Vg A, hDt V CoMpoNeNt ViDeo t o s-ViDeo, CoMposit e ViDeo, 480i CoMpoNeNt ViDeo CoNVeRt eR/sCALeR

The 40-888 allows you to convert VGA or 480i component video to composite video or S-Video. Supports NTSC 3.58, NTSC 4.43, Pal-M, Pal-N or Secam formats. Switchable component video or VGA inputs. Manual push button or IR remote controlled. RS232 for PC control. Easy to use OSD menu allows you to change output resolution, brightness and contrast. Supports input resolutions of 640X480, 800X600, 1024X768 and 1280X1024. Output resolution 480i or 480P. Includes 3 ft. VGA cable, 3 Ft., component video cable, 3 ft. composite video cable, 3 ft. s-video cable, IR remote control, 5Vdc power supply. Size: Length 8" x Width 6" x Height 2".



Vg A Video Cable Component Video Cable Composite Video Cable s-Video Cable

40-880A t Wo WAY pC \ hDt V, hDt V \ pC CoNVeRt eR

This Bi-directional 2 way scaler converts PC VGA to HD component video or HD component video to PC VGA. Supports HD resolutions of 480P, 720P, 1080i and 1080P and PC resolutions of VGA, SVGA, XGA, SXGA, UXGA, WXGA, WSXGA and WUXGA. The comprehensive OSD menu allows users to adjust output resolutions, contrast, brightness, hue, saturation and sharpness. Loop out for local monitor. 5 Volt DC power supply and VGA, VGA to Component cables are included.

specifications:

Input port: 1 X HDB15 Female
 Output port: 1 X HDB 15 Female
 Loop port: 1 X HDB15 Female
 Power Supply 5 Volt DC-110/220
 Dimension: Length 5.75" X Width 4" X Height 1"

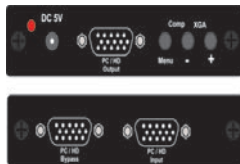

40-881 DVi-D t o Vg A CoNVeRt eR \ sCALeR

The 40-881 is a Digital DVI-D to analog VGA converter and scaler. DVI-D input to HDB15 VGA output. Input resolution is automatically detected while the output resolution and refresh rate can be selected via the OSD menu. The 40-881 has non-volatile memory and memorizes all your settings before the power is turned off and recalls those settings the next time the power is turned on. Supports 480P, 720P and 1080i input resolutions and will output 640X480, 800X600, 1024X768, and 1280X1024 PC resolutions. DVI-D cable and 5Vdc power supply included. Size: Length 5.25" x Width 3" x Height 1.25".

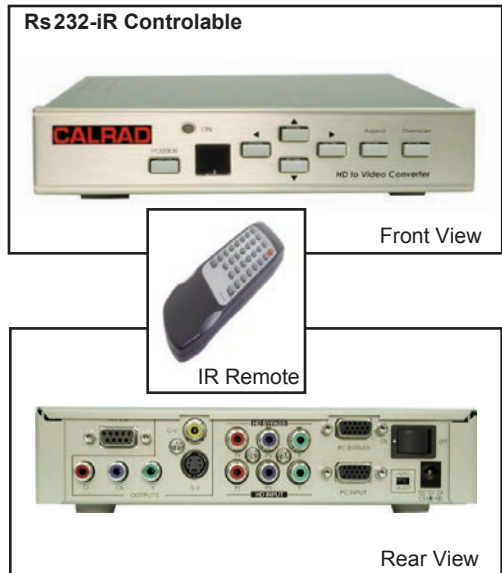

40-884 Vg A / hDt V pAt t eRN geNeRAt oR

The 40-884 is an easy-to-use handheld video pattern generator that generates a wide variety of test patterns for comprehensive testing, calibration, and repair of HDTV or PC monitors, and other display based video equipment. Delivers the quality and functionality you would expect from an expensive high end HDTV pattern generator with an easy to understand three button control interfaces and visible OSD. Size: Length 5.25" x Width 3" x Height 1.25".



CALRAD

40 series - Vg A Converters

40-885

Composite ViDeo t o Vg A CoNVeRt eR \ sCALeR

The 40-885 is a composite video and S-Video to VGA converter/scaler. Composite video and S-Video inputs are scaled up to PC or HDTV resolutions through the OSD menu. Supports NTSC 3.58, NTSC 4.43. Pal-M, Pal-N and Secam formats. Output resolutions for PC are 640X480, 800X600, 1024X768 and 1280X1024. HDTV resolutions are 480P, 720P and 1080i. 5Vdc power supply included. Size: Length 5.25" x Width 3" x Height 1.25".



40-886

Vg A t o DVi-D CoNVeRt eR \ sCALeR

The Calrad 40-886 converts VGA or Y, Pb, Pr component video to DVI-D. can interface between analog VGA and digital DVI-D signals while scaling up or down. The default DVI output resolution is set for 1024 X 768. A backup memory system saves and recalls the previous settings when power is applied. 5Vdc power supply included. Size: Length 5.75" x Width 3" x Height 1.25".



40-40VC01

Vg A t o CoMPosit e ViDeo CoNVeRt eR (pAL-Nt sC sUppoRt)

VGA to composite video converter provides a simple method to view PC based video on any TV, projector, or any other viewing device that uses standard BNC (RCA) type composite video connectors. The converter also features a VGA output port that allows for VGA Loop-Thru. You can simultaneously view video on a VGA monitor while viewing the video on your CRT ,TV monitor. Simple to use push button controls for video setup. Includes DC power supply and 6" M-M vga pigtail cable.

o s D Features: H-Size, V-Size, Brightness, Contrast, Hue, Saturation, Flicker, Sharpness, OSD Background.

specifications

Supported video standards: NTSC/NTSC-EIAJ/PAL/PAL-M/PAL-N/SECAM. Supports Resolutions: 640 x 480 (up to 85 Hz), 800 x 600 (up to 85 Hz) and 1024 x 768 (up to 75 Hz).

Image controls: Horizontal and vertical size, brightness, contrast, hue, saturation, sharpness and on screen display background.

Input Signal: VGA (HDDB15 Female Jack)

Output Signal VGA Loop-Thru (HDDB15 Female Jack)

Output Signal Converted: (BNC Female Jack, Composite Video)

DC Power Coax Jack: 5Vdc, 500ma

Size: Length 3.75" x Width 4.75" x Height 1.25"

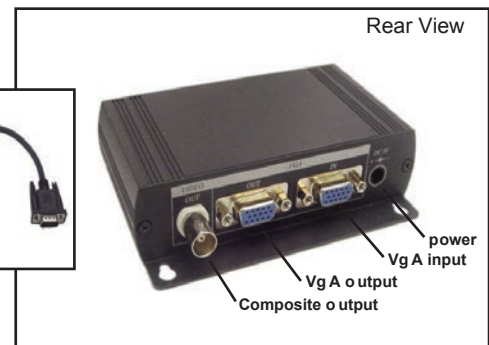
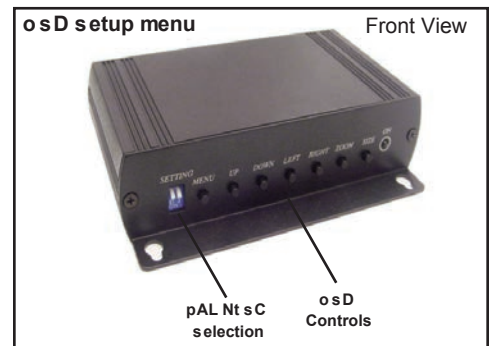

75-547
BNC Male to
RCA Female
adapter, Not
Included.

CALRAD

40 series - Vg A Converters

40-889 Composite ViDeo t o Vg A CoNVeRt eR (640 X 480)

Composite to VGA, (RGB+HV) conversion using 1:1 computer based displays for CCTV applications. Compact size, plug and play installation. OSD Video adjustment for Brightness, Contrast, Color, Tint. **Note !** Your VGA display must be able to render 640 x 480 resolutions in order for this converter to work. Includes 5Vdc, 500ma power supply. See example 1A for typical hookup.

specifications:

Video Formats NTSC & PAL, 1Vpp, 75 ohms, BNC Female Jack
 VGA Output.....0.7 Volts pp RGB+HV (640 x 480) resolution, 15 Pin D Female Jack
 DC Power.....5Vdc
 Current Draw.....200 ma
 Size.....Length: 5.68" (145mm), Width: 2.6" (67mm)
 Height: 1.1", (27mm)
 Weight: (220g)



75-547
BNC Male toRCA Female adapter, not Included.



example 1A

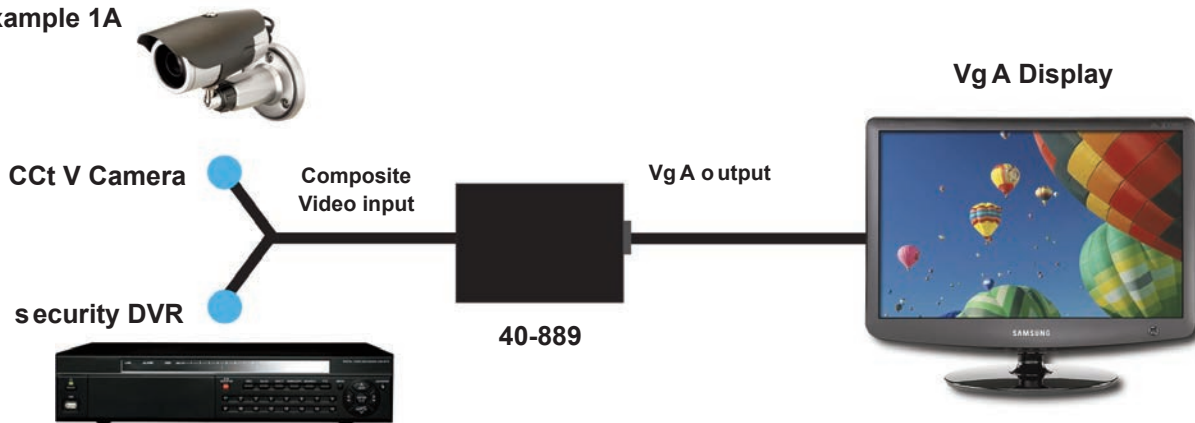

40-822 series sVg A/hDt V Dist RiBUt io N AmpliFieRs

These amplifier/splitters are perfect for driving multiple (2, 4, or 8) analog monitor displays. Supports products up to 1GHz, one port is PNP compatible. Typical usage is 200 MHz for PCs and 350 MHz for HDTV. Comes with front panel L.E.D power indicator. Compatible for use with Calrad 55-612, 55-614, 55-866, 55-620 and 55-621 series cables.

1 DB-15 Female to Female gender changer included.

- 40-822-200200MHz for computer (1 in 2 out)
- 40-822-350350MHz for HDTV (1 in 2 out)
- 40-824-200200MHz for computer (1 in 4 out)
- 40-824-350350MHz for HDTV (1 in 4 out)
- 40-828-200200Mhz for computer (1 in 8 out)
- 40-828-350350Mhz for HDTV (1 in 8 out)

specifications:

Supports SVGA, VGA, XGA and Multisync
 Max resolution 2048 x 1536 @ 60 Hz
 Enhances video signal up to 200 feet
 High density DB-15HD Male (input), Female (output) connectors
 200 & 350 MHz Operates on 9 Vdc, 600 mA
 AC Power Adapter Included
 Rugged metal housing
 Size: **40-822** and **40-824**: (L) 4.75" x (H) 1.75" x (W) 2.75"
40-828: (L) 7.5" x (H) 1.75" x (W) 2.75"



40-822 Rear View



40-824 Rear View



40-828 Rear View

CALRAD

40, 28 series - hDmi Baluns & Wall plates

28-166k hDmi keYst oNe iNseRt

Keystone HDMI 1.3b Female to Female Insert Fits in a standard keystone cutout, 1.3b Certified Female HDMI on front and back Keystone is rotated 90 degrees to insert into any standard keystone faceplate Gold-plated connections. Designer style wall plate not included. Overall depth 1", Color: White.



hDt V

28-166-Lp single Version 28-167-Lp Dual Version

hDmi t o hDmi FeeD-t hRU
White plastic designer style insert plate with single or dual HDMI Female to Female feedthrus. Comes with red L.E.D. signal indicator. Nickel plated. Includes mounting hardware. Color is white.

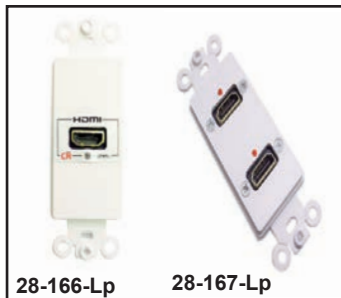

28-166-Lp

28-167-Lp

28-168-1 (1 port), 28-168-2 (2 port) hDmi Desig NeR st YLe WALL pLAt es

Designer style Wall plate with Straight Snap-In HDMI Female to Female Coupler 1 or 2 port Designer style wall plates, with Female/Female gold plated HDMI gender changer module so you can use standard HDMI cables. 1.3b Certified, Color: White.



28-169-1 (1 port), 28-169-2 (2 port) hDmi Desig NeR st YLe WALL pLAt es

Designer style Wall plate with 90 Degree Snap-In HDMI Female to Female Coupler 1 or 2 port Designer style wall plates, with 90 degree (Right Angle) Female/Female HDMI gender changer module so you can use standard HDMI cables inside walls without having to bend your cables at angles that could damage them. Includes a single or double Designer style plate. 1.3b Certified, Color: White.

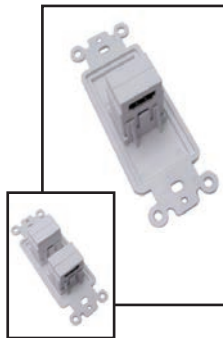

28-171-1 (1 port), 28-171-2 (2 port)

Designer Style Dual Port HDMI HDMI1.3 Female to Female Couplers Fits into the designer style wall plates with inner locking snap-in cutouts, included, Color: White.



28-172 hDmi / Co mpo NeNt WALL pLAt e

Designer style HDTV Video Wall plate with HDMI and Component Video Feed-Thru Jacks Gold plated HDMI F/F and 3 RCA F/F connectors, Color Coded: RED, GREEN, BLUE allow you to couple two HDMI cables and Component Video cables together within a in-wall installation. Perfect for HDTV and home theater needs. Color: White.

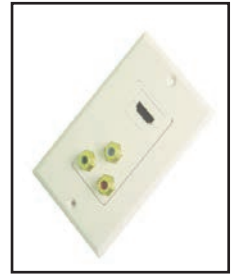

40-1074 hDmi BALUN

Designer style looking wall plate HDMI Balun over 2 Cat5e/Cat6 Cables
Cable Distance (CAT5e) 1080P, 100 ft., CAT6 Cable 125 ft. 1080i, 200 ft. 720P, 200 ft. 480P, 300 ft. HDMI In/Out Connectors: 19 pin Female Jacks, 2 x RJ45 Shielded Jacks each unit. Color: White Dimensions: L-4.5" x W-2.75" x D-1.25".



40-1075 Desig NeR st YLe WALL pLAt e BALUN, hDmi AND iR oVeR 2 Cat 5e/Cat 6 CABLEs

HDMI 1.3b and IR designer style wall plate balun system over two Cat5e, Cat 6 cables. Cable Distance (CAT5e) 1080P, 100 ft., CAT6 Cable 125 ft. 1080i, 200 ft. 720P, 200 ft. 480P, 300 ft. HDMI In/Out Connectors: 19 pin Female Jacks, 2 x RJ45 Shielded Jacks each unit, 2 x 3.5mm jacks (IR). Includes IR Receiver, Emitter, External AC power adapter. Color: White.

Note: Do not use other manufactures receivers with this balun, only the included receiver will work.

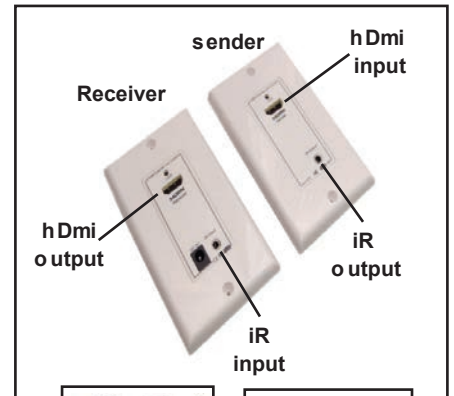

iR Receiver, emitter



Rear View

40-hW01 hDmi AND iR WALL pLAt e BALUN

HDMI 1.3 and IR wall plate balun system over two Cat5e, Cat 6 cables. Transmission Distance (CAT5e) 1080P, 100 ft., CAT6 Cable 125 ft. 1080i, 200 ft. 720P, 200 ft. 480P, 300 ft.. External AC power adapter included. Color: White, Sold in pairs.



CALRAD

40 series - Vg A switchers

40-829-2, 2 iNpUt 1 oUt pUt mANUAL Vg A sWit CheR

2 X 1 Manual VGA switcher. Max Input Video Level 1.5V p-p. Video Bandwidth 250 MHZ. Video Resolutions up to 1920 x 1440. Front panel selection buttons, Connectors: Input\Output HD-DB15 Female Jacks. LED selection indicators. DC Power 9Vdc 300ma Power supply included. Dimensions: Length 3.0" x Width 5.125" x Height 1.6".

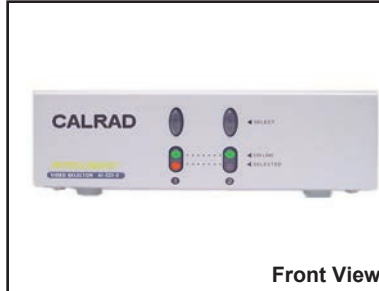

Front View



Rear View

40-829-4, 4 iNpUt 1 oUt pUt mANUAL Vg A sWit CheR

4 X 1 Manual VGA switcher. Max Input Video Level 1.5V p-p. Video Bandwidth 250 MHZ. Video Resolutions up to 1920 x 1440. Connectors: Input\Output HD-DB15 Female Jacks. LED selection indicators. DC Power 9Vdc 300ma Power supply included. Size: Length 3.0" x Width 8.0" x Height 1.6".

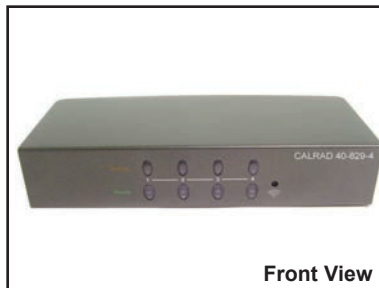

Front View



Rear View

40-829R-4, 4 iNpUt 1 oUt pUt mANUAL oR iR Vg A sWit CheR

4 X 1 Manual or IR remote controlled VGA switcher. Max Input Video Level 1.5V p-p. Video Bandwidth 250 MHZ. Video Resolutions up to 1920 x 1440. Connectors: Input\Output HD-DB15 Female Jacks. LED selection indicators. Auto-scan Function adjusts input scan from 5 - 30 seconds. Skips un-active video ports. DC Power 9Vdc 300ma Power supply included. Remote control included. Size: Length 3.0" x Width 8.0" x Height 1.6".



iR Remote

40-829-8, 8 iNpUt 1 oUt pUt mANUAL Vg A sWit CheR

8 X 1 Manual VGA switcher. Max Input Video Level 1.5V p-p. Video Bandwidth 250 MHZ. Video Resolutions up to 1920 x 1440. Connectors: Input\Output HD-DB15 Female Jacks. LED selection indicators. DC Power 9Vdc 300ma Power supply included. Size: Length 3.0" x Width 8.0" x Height 1.6".

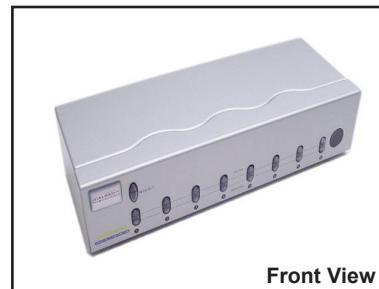

Front View



Rear View

40-829R-8, 8 iNpUt 1 oUt pUt mANUAL oR iR Vg A sWit CheR

8 X 1 Manual or IR remote controlled VGA switcher. Max Input Video Level 1.5V p-p. Video Bandwidth 250 MHZ. Video Resolutions up to 1920 x 1440. Connectors: Input\Output HD-DB15 Female Jacks. LED selection indicators. Auto-scan Function adjusts input scan from 5 - 30 seconds. Skips un-active video ports. DC Power 9Vdc 300ma Power supply included. Remote control included. Size: Length 3.0" x Width 8.0" x Height 1.6".



iR Remote

CALRAD

40 series - kVm/VgA switchers

40-825-8, 8X1 kVm sWit CheR

Control eight computers with ONE PS/2 Keyboard / PS/2 Mouse / Monitor. Supports standard PS/2 mouse, Intellimouse, etc. Easy to operate and install - No software required. Keyboard and mouse emulation for error free PC booting PC selection via push button switches or hot key. Auto scan function to monitor PC operation, scan interval 5-30 seconds. Superior video quality: up to 1920 x 1440. Controls PC's with one keyboard, mouse and monitor. Auto skip on PC power off - Hot pluggable. Metal Chassis, Size: Length 13.5" x Width 4.125" x Height 1.75". Includes 9Vdc, 300ma power supply and 19" 1U rack mount ears.

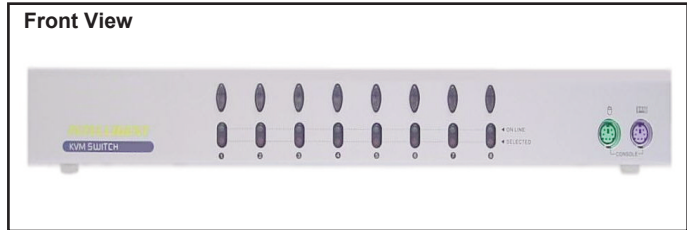

40-4140 4X4 VgA mAt RiX sWit CheR

The 40-4140 is an 4 input 4 output VGA matrix switcher ideally suited for HDTV or PC applications. Supports XGA, SXGA, UXGA and WUXGA PC resolutions. 380Mhz video bandwidth supports 1080i HDTV resolution. The matrix switcher allows you to assign any of the 4 VGA inputs to any of the 4 VGA outputs through the manual push button controls or IR remote control. RS232 interface for PC control. 12Vdc power supply, IR remote control and the windows based software driver included. Size: Length 8.25" x Width 19" x Height 1.75".



IR Remote



40-8180 8X8 VgA mAt RiX sWit CheR

The 40-8180 is an 8 input 8 output VGA matrix switcher ideally suited for HDTV or PC applications. Supports XGA, SXGA, UXGA and WUXGA PC resolutions. 380Mhz video bandwidth supports 1080i HDTV resolution. The matrix switcher allows you to assign any of the 8 VGA inputs to any of the 8 VGA outputs through the manual push button controls or IR remote control. RS232 interface for PC control. 12Vdc power supply, IR remote control and the windows based software driver included. Size: Length 8.25" x Width 19" x Height 1.75".



IR Remote



40-8188 8X8 VgA mAt RiX sWit CheR Wit h AUDio

The 40-8188 is an 8 input 8 output VGA matrix switcher with 3.5 stereo audio ideally suited for HDTV or PC applications. Supports XGA, SXGA, UXGA and WUXGA PC resolutions. 380Mhz video bandwidth supports 1080i HDTV resolution. The matrix switcher allows you to assign any of the 8 VGA and audio inputs to any of the 8 VGA and audio outputs through the manual push button controls or IR remote control. RS232 interface for PC control. 12Vdc power supply, IR remote control and the windows based software Driver included. Size: Length 8.25" x Width 19" x Height 1.75".



IR Remote



40 series - Vg A Wallplates/Adapters

28-160

**siNg Le high DeNsit Y DB-15
FeeD-t hRU AND DUAL RCA
FeeD-t hRU JACKs**

White plastic designer insert plate. HD-DB-15 high density Female to Female jack with red/white RCA Female to Female jacks. Includes mounting hardware.

28-160.....Nickel

28-160g.....Gold

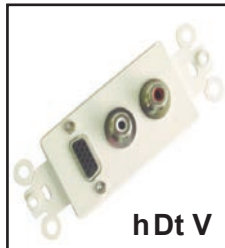

hDt V

28-161-3.5

**3.5 high DeNsit Y DB-15 AND
3.5mm FeeDt hRU JACKs**

White plastic designer style insert plate. (1) HD-DB-15 high density Female to Female jack and (1) 3.5mm Female to Female stereo jack. nickel plated connectors. Includes mounting hardware.

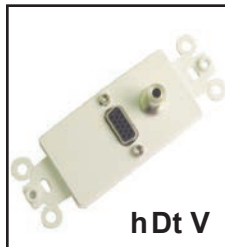

hDt V

28-161

**siNg Le high DeNsit Y DB-15
FeeD-t hRU**

White plastic designer style insert with a single HD-DB-15 feed-thru jack. Available in nickel or gold plated versions. Includes mounting hardware.

28-161.....Nickel

28-161g.....Gold

28-161-t.....VGA terminal block with screws.



hDt V

28-162

**DUAL high DeNsit Y DB-15
FeeD-t hRU**

White plastic designer style insert plate. 2 HD-DB-15 high density Female to Female jacks. Comes in either nickel or gold versions. Includes mounting hardware.

28-162.....Nickel

28-162g.....Gold

28-162-m-2.....Metal Plate



hDt V



**35-700
DVi-i male to Vg A
DB-15 Female
Adapter**

Allows you to connect VGA display to a DVI-I graphics card. note, this adapter does not provide a digital to analog signal conversion. It will not work with DVI-D.



**35-701
DVi-A male to Vg A
DB-15 Female
Adapter.**

This adapter allows you to connect a DVI-A display to a VGA graphics card.



**35-722
m1DA male plug to
DB-15 Female
plug.**

6 inch cord and Gold plated contacts.



Vg A ViDeo

pC or hDt V

30-587 Nickel
30-587g Gold
15-pin Female to Female gender changer. High density "D" connector sockets for inline or panel mounting.



Vg A ViDeo

pC or hDt V

30-588
30-588g gold
15-pin Male to Male gender changer. High density "D" connector plugs for inline or panel mounting.



Vg A ViDeo

35-704
15 pin VGA Male to Female right angle adapter for projectors. Cable exits up from the jack.



Vg A ViDeo

35-704A
15 pin VGA Male to Female right angle adapter for projectors. Cable exits down from the jack.

CALRAD

40 series - Audio/Video Balun extenders

40-6920 CAT 5e Co mpo NeNt / Co mposit e ViDeo / Dig it AL / st eReo AUDio ReCeivER BALUN

The 40-6920 is a CAT 5 based component video, composite video, PCM digital audio and stereo audio distribution amplifier receiver. Designed to work together with the transmitter unit 40-6950. The receiver unit can be up to 1000 ft away from the transmitter unit. The receiver has RCA loop outputs for cascading to another distribution amplifier. Will support HDTV resolutions of 480P, 720P, 1080i and 1080P. Transmission distance for 480P 1000 feet, 720P 600 feet and 1080i or 1080P 450 feet. 12 Vdc power supply included.



40-6930 CAT 5e Co mpo NeNt / Co mposit e ViDeo/Dig it AL / st eReo AUDio ReCeivER / RepeAt eR BALUN

The 40-6930 is a CAT 5 based component video, composite video, PCM digital audio and stereo audio distribution amplifier receiver. Designed to work together with the transmitter unit 40-6950. The receiver unit can be up to 1000 ft away from the transmitter unit. The receiver has a CAT5 loop output for cascading to another distribution amplifier. Will support HDTV resolutions of 480P, 720P, 1080i and 1080P. Transmission distance for 480P 1000 feet, 720P 600 feet and 1080i or 1080P 450 feet. 12 Vdc power supply included.



40-6950 CAT 5e Co mpo NeNt / Co mposit e ViDeo / Dig it AL / st eReo AUDio t RANsmit t eR BALUN

The 40-6950 is a CAT 5 based component video, composite video, PCM digital audio and stereo audio distribution amplifier transmitter. Designed to work together with the 40-6920 or 40-6930 receiver units. The receiver unit can be up to 1000 ft away from the transmitter unit. The transmitter has RCA Inputs and RCA loop outputs as well as buffered RJ 45 outputs. Will support HDTV resolutions of 480P, 720P, 1080i and 1080P. Transmission distance for 480P 1000 feet, 720P 600 feet and 1080i or 1080P 450 feet. 12 Vdc power supply included.



This Balun system can provide multiple configurations for large scale Audio-Video signal delivery for standard or HDTV. Signals from the Transmitter can be sent to a Receiver (40-6920) or a Receiver / Repeater (40-6930) to further extend the signals to multiple locations.

**40-6950
Transmitter**



**Large scale hDt V signal
Distribution over Cat5e / Cat6**



**40-6930
Receiver,
Repeater**



**40-6920
Receiver**

Video pattern generators

40-884 Vg A / CompoNeNt ViDeo hDt V pAt t eRN geNeRAt oR

The 40-884 is an easy-to-use handheld video pattern generator that generates a wide variety of test patterns for comprehensive testing, calibration, and repair of HDTV or PC monitors, and other display based video equipment. Delivers the quality and functionality you would expect from an expensive high end HDTV pattern generator with an easy to understand three button control interfaces and visible OSD, 27 patterns total. 5Vdc power supply included. Size: Length 5.25" x Width 3" x Height 1.25".



PC Resolutions: VGA, SVGA, XGA, WXGA, SXGA.
HDTV Resolutions: 480P, 576P, 720P, 1080i.

40-CphD-1 1080p DVi / hDmi hDt V pAt t eRN geNeRAt oR

The 40-CPHD-1 HDMI Pattern Generator is a handy tool for evaluation and testing of HDMI displays. With the combination of 39 timings, 39 patterns and color spaces, the easy to read front panel LCD display can provide access for up to 4095 types of video testing signals. Besides video patterns, the generator also supports digital and analog audio testing signals. You can use the front panel buttons or the ir remote control to select different timings, patterns, color spaces. HDMI output with analog, digital audio input jacks selectable internal audio sinewave signal or external audio sources. The 9 pin RS232 control port can be used with the bundled Windows software application to perform advanced control, such as timing/pattern programming, EDID reading and writing. ear panel on/off power switch. 5Vdc power supply, 3 ft. stereo RCA, digital toslink cables, included. Color: Beige. Size: Length 11.1" x Width 5.5" x Height 1.75".



IR Remote Control



Front View



Rear View

PC Resolutions: VGA, SVGA, XGA, WXGA, SXGA. HDTV Resolutions: 480P, 576P, 720P, 1080i, 1080P.

40-883 DVi-hDmi pC / hDt V ViDeo pAt t eRN geNeRAt oR

The 40-883 DVI test pattern generator provides over 20 of the most-often-used test patterns for calibration, testing and troubleshooting DVI-D or DVI-I signals. It is ideal for use with LCD monitors, PC monitors or projectors that are equipped with DVI-I or DVI-D inputs. Easy to use OSD menu allows you to select a variety of test patterns. Grey scale and multiburst. Includes 3ft. DVI-DVI cable. 35-711A DVI to HDMI adapter, 35-700 DVI-I to VGA adapters sold separately. 5Vdc power supply included. Size: Length 5.75" x Width 3" x Height 1.25".



PC Resolutions: VGA, SVGA, XGA, WXGA, SXGA. HDTV Resolutions: 480P, 576P, 720P, 1080i.



35-711A
HDMI Female to DVI-D Male Adapter with Gold plated contacts.



35-700
Dvi-i mALE to VgA DB-15 FemALE ADAPT eR
Allows you to connect a VGA cable to DVI-A sources.

CALRAD

40 series - switches

spst RoCkeR

sWit Ches Wit h L.e.D.

(Switch contacts rated 5 AMP-125 VAC) Easy Snap-in mounting. Hole size $\frac{3}{4}$ " x $\frac{1}{2}$ ". Dropping resistor required. DC voltage: 6 vdc-270 ohms, 12 vdc-680 ohms, 24 vdc-1.5k.

40-710 Red LED
40-711 Green LED
40-712 Orange LED

L.e.D indicator



40-600, spst

40-601, DpDt

t o g g L e s W i t C h

SPST bakelite case, bat handle with chrome on/off plate. Solder-type terminals. Rated 3 Amp, 125 volt.

40-600 Size: 1" x $\frac{3}{16}$ " x $\frac{1}{8}$ " deep to top of $\frac{7}{16}$ " bushing.

40-601 Size: $\frac{1}{8}$ " x $\frac{3}{4}$ " x $\frac{1}{4}$ " deep to top of $\frac{7}{16}$ " bushing.



40-635

spDt iLLUmiNAt eD RoCkeR sWit Ch

SPST switch. Rated 10 Amp, 125 volt. Neon bulb operates on 117 AC line. Has built-in resistor, $\frac{1}{4}$ " x $\frac{5}{8}$ " top dimensions.

40-635A
 12 volt DC version of 40-635.



40-602

heAVY DUT Y CeNt eR-oFF

t o g g L e s W i t C h

DPDT center-off, rated 6 Amp, 125 volt, bat handle, red and black on/off plate. Screw terminals.

Size: $\frac{5}{16}$ " x $\frac{3}{4}$ " x $\frac{1}{8}$ " deep, mounts in $\frac{7}{16}$ " hole.



L.e.D. t o g g L e s W i t C h e s

3 Amp, 125 Vac, attractive, slim, cylindrical handle, with built-in L.E.D indicator light in the tip. Solder-type terminals. Body size: $\frac{3}{4}$ " x $\frac{1}{2}$ " x $\frac{11}{16}$ " deep (including pins). Bushing size: $\frac{7}{16}$ ". Dropping resistor required. DC voltage: 6 vdc-270 ohms, 12 vdc-680 ohms, 24 vdc-1.5k.

40-593 SPDT Red L.E.D
40-594 SPDT Green L.E.D

L.e.D indicator



40-691

heAVY DUT Y t o g g L e s W i t C h

SPST 6 Amp, 125 Vac. Body size: $\frac{1}{8}$ " x $\frac{5}{8}$ " x $\frac{7}{8}$ " deep. Screw terminals. Mounts in $\frac{1}{2}$ " hole.

40-692

DPDT 6 Amp, 125 Vac. Body size: $\frac{5}{16}$ " x $\frac{3}{4}$ " x $\frac{3}{4}$ ". Screw terminals. Mounts in $\frac{1}{2}$ " hole.



heAVY DUT Y 20 Amp (125V)

sWit Ches

Mounts in $\frac{1}{2}$ " hole. Bushing size: $\frac{15}{32}$ " dia. x $\frac{3}{8}$ " long. Body size: $\frac{1}{8}$ " x $\frac{5}{8}$ " x 1" deep.

40-560 SPST (On-Off)
40-561 SPDT (On-Off-On) Center Off



miNiAt URe FLAt t o g g L e s W i t C h seRies

Specially designed for decorative appearance with ease in smooth switching operation in mind. Specify part number.

s p e c i f i c a t i o n s

Contact rating: 6 Amp-125 Vac, 3 Amp-250 Vac.
 Bushing: $\frac{1}{4}$ ". Thread length: $\frac{5}{16}$ ".

All necessary mounting hardware included.



heAVY DUT Y 20 Amp (125V)

sWit Ches

Mounts in $\frac{1}{2}$ " hole. Bushing size: $\frac{15}{32}$ " dia x $\frac{3}{8}$ " long. Body size: $\frac{5}{16}$ " x $\frac{3}{4}$ " x 1" deep.

40-562 DPDT (On-On)
40-563 DPDT (On-Off-On) Center Off

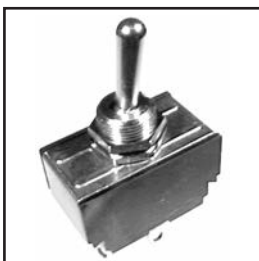

40-580..... SPDT, On-On

40-581.....SPDT, On-On Momentary

40-582.....SPDT, On-Off-On

40-583.....SPDT, On-Off-On, Mom.

40-584.....SPDT,-On-Off-On, Mom.

Body Size 40-580 thru 40-584: $\frac{1}{2}$ " x $\frac{5}{16}$ " x $\frac{1}{2}$ " deep including terminals



heAVY DUT Y t o g g L e

sWit Ches

Fast snap action toggles. Extremely smooth operation. Flat chrome handle. Rate 6 Amps, 250 volts. Silver contacts. Specify type. Both mount in $\frac{1}{2}$ " hole. Bushing size: $\frac{15}{32}$ " dia x $\frac{3}{8}$ " long.

40-605 SPDT $\frac{1}{8}$ " X $\frac{5}{8}$ " X $\frac{13}{16}$ "
40-606 DPDT $\frac{1}{8}$ " X $\frac{3}{4}$ " X $\frac{13}{16}$ "



40-585.....DPDT, On-On

40-586.....DPDT, On-On Momentary

40-587.....DPDT, On-Off-On

40-588.....DPDT, On-Off-On Mom.

40-589.....DPDT, On-Off-On Mom.

Body Size 40-585 thru 40-589: $\frac{1}{2}$ " x $\frac{1}{2}$ " x $\frac{1}{2}$ " deep including terminals.

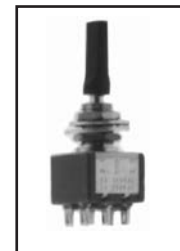

CALRAD

40 series - switches

miNiAt URe CiRCUIt BoARD moUNT iNg sWit Ches

Right angle mounting - $\frac{5}{16}$ " long threaded bushing. Contact rating 6 Amp, 125 Vac. All mount in $\frac{1}{4}$ " hole.
40-502 DPDT On-On
40-503 DPDT On-Off-On
 Body Size: $\frac{1}{2}$ " x $\frac{1}{2}$ " x $\frac{3}{4}$ " deep including terminals



miNiAt URe CiRCUIt BoARD moUNT iNg sWit Ches

Printed circuit mounting - $\frac{5}{16}$ " long threaded bushing. Contact rating 6 Amp, 125 Vac. All mount in $\frac{1}{4}$ " hole.
40-521 SPDT On-Off-On
 Body Size: $\frac{1}{2}$ " x $\frac{5}{16}$ " x $\frac{5}{16}$ " deep including terminals
40-523 DPDT On-Off-On
 Body Size: $\frac{1}{2}$ " x $\frac{1}{2}$ " x $\frac{5}{16}$ " deep including terminals

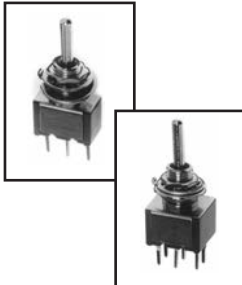

sUB-miNiAt URe t oGg Le sWit Ches

40-610 SPDT-ON/ON, 10 Amp, 125 volt (non-inductive load), solder-type terminals. Body size: $\frac{5}{16}$ " x $\frac{1}{2}$ " x $\frac{9}{16}$ ".
40-611 DPDT, 10 amp, 125 volt (non-inductive load), solder-type terminals. Body size: $\frac{1}{2}$ " x $\frac{1}{2}$ " x $\frac{1}{2}$ ".
40-612 DPDT, center-off. Contact 5 Amp, 125 volt current cap. AC (non-inductive load). Body size: $\frac{1}{2}$ " x $\frac{1}{2}$ " x $\frac{1}{2}$ ".



ULt RA smALL sUB-miNiAt URe t oGg Le sWit Ches

3 Amp, 125 Vac. Chrome handle with red tip for eye-catching indication. $\frac{3}{16}$ " dia. Bushing: $\frac{7}{32}$ " long.
40-608 SPDT-ON/ON
 body size: $\frac{5}{16}$ " x $\frac{3}{16}$ " x $\frac{1}{2}$ " deep including terminals
40-609 DPDT-ON/ON
 body size: $\frac{11}{32}$ " x $\frac{5}{16}$ " x $\frac{1}{2}$ " deep including terminals



miNiAt URe CiRCUIt BoARD moUNT iNg sWit Ches

Vertical mounting - $\frac{5}{16}$ " long threaded bushing. Contact rating 6 Amp, 125 Vac. All mount in $\frac{1}{4}$ " hole.

40-511 SPDT On-Off-On
 Size: $\frac{1}{2}$ " x $\frac{5}{16}$ " x $\frac{7}{8}$ " deep including terminals
40-512 DPDT On-On
40-513 DPDT On-Off-On
 Size: $\frac{1}{2}$ " x $\frac{1}{2}$ " x $\frac{7}{8}$ " deep including terminals

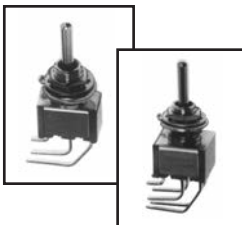

miNiAt URe eCoNomY t oGg Le sWit Ches W/ siLVeR pLATeD CoNt Act s

3A-125 Vac, mounts in $\frac{1}{4}$ " hole size, solder terminals. $\frac{5}{16}$ " long threaded bushing.
40-566 SPDT On-On
40-567 SPDT On-Off-On
 Size: $\frac{1}{2}$ " x $\frac{5}{16}$ " x $\frac{9}{16}$ " deep including terminals
40-568 DPDT On-On
40-569 DPDT On-Off-On
 Size: $\frac{1}{2}$ " x $\frac{1}{2}$ " x $\frac{9}{16}$ " deep including terminals

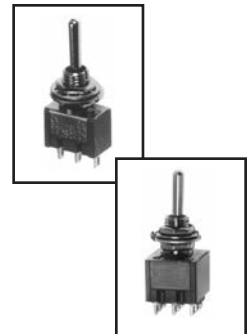

sUB-miNiAt URe t oGg Le sWit Ches

Extra small in size, chrome handles with red tip for quick eye-catching indication, 3 Amp, 125 Vac.
40-613 SPDT-ON/ON
 Size: $\frac{7}{16}$ " x $\frac{1}{4}$ " x $\frac{9}{16}$ " deep including terminals
40-614 DPDT-ON/ON
 Size: $\frac{7}{16}$ " x $\frac{7}{16}$ " x $\frac{9}{16}$ " deep including terminals Bushing: $\frac{1}{4}$ " dia x $\frac{1}{4}$ " long.



sUB-miNiAt URe t oGg Le sWit Ch

6 Amp, 125 Vac, $\frac{1}{4}$ " mounting hole. $\frac{5}{16}$ " thread length.
40-699 SPDT-ON/ON
 body size $\frac{3}{4}$ " x $\frac{1}{2}$ " x $\frac{5}{8}$ "
40-700 DPDT-ON/ON
 body size $\frac{7}{8}$ " x $\frac{1}{2}$ " x $\frac{9}{16}$ "

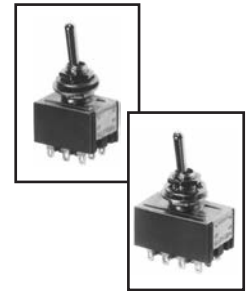

LeVeR sWit Ches

6 Amp, 125 Vac, mounts in $\frac{3}{4}$ " round hole. Lever color is red. Lever height is .99"
40-705 DPDT-ON/ON
40-706 SPDT-ON/ON



RoCkeR sWit Ches

6 Amp, 125 Vac, mounts in $\frac{3}{4}$ " round hole. Rocker color is white. Size is .7"
40-707 SPDT-ON/ON
40-708 DPDT-ON/ON



40-630 spst RoCkeR sWit Ch

Molded plastic, encased with mounting flanges. Mounting centers: $\frac{1}{32}$ "
 Size: $\frac{1}{2}$ " x $\frac{1}{2}$ " x $\frac{7}{8}$ ".
 Rating: 3 amps, 125 volts AC.



CALRAD

40 series - switches

40-632 spDt -oN/oN

RoCkeR sWit Ch

Molded plastic, encased with mounting flanges. Mounting centers: 1 7/8" Size: 1 11/16" x 5/8" x 1 1/16". Rating: 3 amps, 125 volts AC.



RoCkeR sWit Ches

6 Amp, 125 Vac, mounts in 3/4" round hole. Color is black.

40-687 DPDT-ON/ON

40-690 SPDT-ON/ON



40-620

sLiDe sWit Ch

DPDT, positive action. Size 1 3/8" x 1/2". Mounting centers: 1 1/8". Rated 0.5 Amp, 125 volt. Color is black.

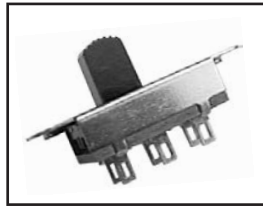

40-621

CeNt eR-oFF sLiDe sWit Ch

Same as the 40-620 except for center-off position. Color is black.

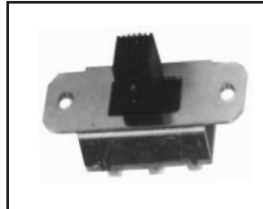

miNi sLiDe sWit Ches

Used where small size is necessary. Rated 0.25 Amp, 125 volt. Size: 5/16" x 5/8" x 3/8" deep including terminals.

40-622 SPDT Mtg. Centers 1 1/16"

40-623 DPDT Mtg. Centers 3/4"



heAVY DUt Y ChRome

pUshBUt t oN sWit Ch pUsh oN/pUsh oFF

10 Amp, 125 Vac. Mounting hole size: 15/32". Thread length: 1/2"

40-595 SPDT 1 1/8" x 5/8" x 3/4"

40-596 DPDT 1 1/8" x 3/4" x 7/8"



40-615 / 40-615-W (white cap)

spDt miNiAt URe

pUshBUt t oN sWit Ch

Push-on/push-off, 3 Amp, 125 Vac. Hole size 1/4". Body Size 1/4" x 15/32" x 7/8" L - including terminals. Body color is green, button color available in black or white.



40-616

DpDt miNiAt URe pUshBUt t oN sWit Ch

Same as 40-615.

7/16" x 7/16" x 7/8" L - including terminal. Body color is green, button color is black.



40-626

sUB-miNiAt URe

mo meNt ARY sWit Ch spst pUsh t o mAKe

0.5 Amp, 125 Vac. Fits 3/16" hole, 1/4" dia, length 13/16" overall. Button color is black.



heAVY DUt Y

pUshBUt t oN sWit Ch

SPST momentary, push to make. Rated 3 Amp, 125 volt. Specify color. Hole size: 5/8".

40-627Black 40-629-BU Blue

40-628Red 40-629-Wh White

40-629 ...Green 40-629-YL Yellow



miNiAt URe pUshBUt t oN sWit Ch

SPST momentary, ideal for panel mounting. Rated 1 Amp, 125 volt, 1 1/8" overall length, diameter 7/16", fits 1/4" hole.

40-636 Push to Break, Black

40-637 ...Push to Make, Red, Japan

40-637-s Same as 40-637 but from Taiwan



mo meNt ARY pUshBUt t oN sWit Ches

Rated 3 Amp, 250 Vac. Bushing: 7/16". Hole size: 1/2".

40-688SPST Push-on—Red

40-689SPST Push-on—Cream



spDt mo meNt ARY pUsh t o mAKe oR BReAk

Rated 3 Amp, 125 Vac. Mounting hole: 1/4". Body size: 7/16" x 7/16" x 1 1/16". Normally open or normally closed.

40-693 Red

40-694 Black



40-697

spst mo meNt ARY pUsh t o mAKe

1 Amp, 125 Vac. Overall length: 1 1/8". Mounting hole: 1/4". Button color is black.



CALRAD

40 series - security switches

40-625 iNLine pUsh BUt t o N sWit Ch

Red N/O momentary push button switch mounted in a silver XLR housing. Operating voltage 125Vac, 3Amp max. current. Accepts up to .30" cable.

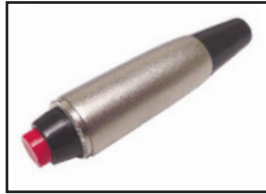

40-698 spst moMeNt ARY pUsh t o mAke sWit Ch

1 Amp, 125 Vac. Mounting hole: 1/2". Overall length: 3/4".



40-565 miCRo-miNiAt URe pUshBUt t o N keYBoARD sWit Ch

Rating.....50 mA at 12 Vdc.Contact resistance.....100 MΩ Max. Voltage breakdown..100 Vac/minute Life expectancy.....100,000 cycles Dimensions.....1/4" L X 1/4" W X 5/16" D

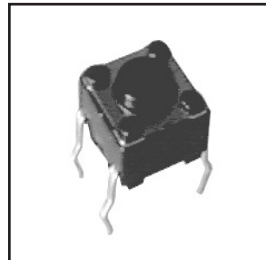

40-634 spDt miCRo LeVeR sWit Ch

Leaf-type, normally open or normally closed momentary contact 1/2 Amp, 125 Vdc; 5 Amps, 1/6 h.p., 125 or 250 Vac. Body size: 1 1/8" x 5/8" x 3/8" not including contacts.

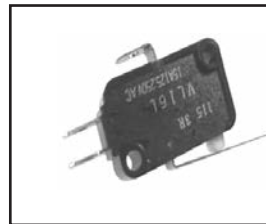

40-651 moMeNt ARY Foot sWit Ch

Push to make, can be reversed. Used for remote operation. Metal case has slip-proof bottom, 60-inch lead, has 1/4" plug. Size: 3 1/8" x 3 3/8" x 1". Ratings: 0.5 amp, 125 volts AC.



40-678 12 VoLt DC spDt ReLAY

DC resistance 5K. Current 1.5 mA. Contact Rating: 500 mA.

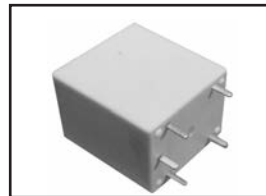

spDt miNiAt URe ReLAYS

Sensitive, lightweight, fully encased. Pin type terminal leads for easy connection on printed circuit boards. 3 Amp contacts. Size: 5/8" x 3/4" x 29/32". Specify model number.

40-674

6Vdc SPDT, DC resistance 100 ohms, current 60dc mA

40-675

12Vdc SPDT, DC resistance 350 ohms, current 34 mA



DpDt miNiAt URe Dip st YLe ReLAYS

40-760 5Vdc - 3.6 Vdc Min, DC Resistance 167 ohms

40-761 12Vdc - 8.5 Vdc Min, DC resistance 388 ohms

40-762 24Vdc - 16.8 Vdc Min, DC Resistance 960 ohms

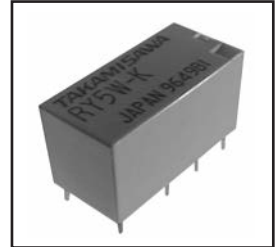

Small and perfect for low signals in audio, computer, telcom, and security products. Fully sealed construction.

Contact rating (resistive) .5A 120Vac, 1Amp, 24 Vdc, .3Amp, 60 Vdc

Diagram for 40-760, 40-761, & 40-762

Wiring Diagram (bottom view)

Drilling Plan (in mm) (bottom view)

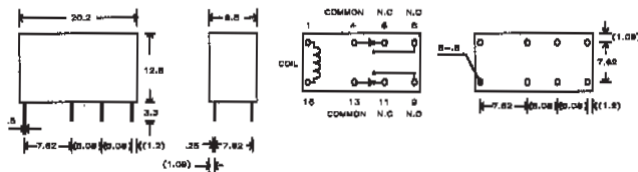

40-763 smALL seCURit Y mAg Net iC Co Nt ACT (Whit e)

Closed circuit switch with magnet in place. 18" white wired leads exit at the end. Mounts with self adhesive tape. Size: L-1.1" x W-.371" x H-.24".



40-764 smALL seCURit Y mAg Net iC Co Nt ACT (Whit e)

Closed circuit switch with magnet in place. 18" white wired leads exit at the middle. Size: L-1.1" x W-.371" x H-.24".



Small Slotted Screw Driver Required

screw terminals



40-765 smALL seCURit Y mAg Net iC Co Nt ACT (Whit e)

Closed circuit with magnet in place. Screw terminals accept 22-26 Awg cable. Mounts with self adhesive tape. Size: L-1.1" x W-.371" x H-.24".

40-715 Bi-piN 6 Vo Lt iNCANDesCeNt BULB



CALRAD

40 series - security switches

mAg Net iC

Co Nt Act s Wit Ches

Versatile, used in many alarms sensing for window and door protection. Specify either normally open or normally closed. Mounting center: 2 1/8" 130V max. 50 mA or 10 watts. Up to .5 Amp max.

- 40-656** Normally Closed
40-657 Normally Open
 (Both with magnet in place.)



40-755

3/8" ReCesseD Co Nt Act

Switch/magnet case with ribs for securing in holes, 1" operating gap. Closed circuit with magnet in place. Available in white only. Rating 100mA-100 Vdc, 1 Amp-10 Vdc. Contact length is 1.32". Wire length is 15".



sURFACE mo UNT

Co Nt Act s

Includes terminal cover. 3/4" operating gap. Available in white only. Rated 100mA - 100 Vdc max.

- 40-750** Normally Closed
40-751 Normally Open
 (Both with magnet in place.)



40-655 WAT eR s eNsIng

Co Nt Act s Wit Ch

When the switch senses water (or any conductive liquid) it acts as a high resistance N/O contact. This switch only works with specific security alarm panels that support this type of switch.



40-752 WiDe g Ap sURFACE mo UNT Co Nt Act

Used for loose fitting doors and windows. 2 3/4" operating gap. Includes spacers. Normally closed with magnet in place. Color is grey. Rated 100mA-100 Vdc max.



40-753-g Y

sURFACE

mo UNT Co Nt Act

15" prewired leads. Foam tape mounting. Closed circuit with magnet in place. Available in grey only.



seLF-ADhesiVe Co Nt Act s

Alarm switches for window and door protection, with 12" wire leads. 1 1/2" length, 3/8" wide. 0.5 amp, 125VDC. Rated 100mA-100V max., 1 amp-10Vdc max., 10 watts max. Self-adhesive and screw mount.

- 40-665** Closed Circuit w/ magnet in place
40-666 Open Circuit w/ magnet in place



40-668 mAg Net iC FLo o R s Wit Ch

Extra wide gap. Magnetic contacts embedded in solid aluminum block. Switch wires protected in a flexible steel jacket. Size: 5/8" x 1/4" x 3 1/2" L. Normally closed with magnet in place. 2 1/2" operating distance. Alnico magnet. UL approved. Rating 100mA-100Vdc max., 1 Amp-10Vdc max., 10 watts max.



ReCesseD mAg Net iC s Wit Ch

Complete concealment, positive action, easy to install, recesses into 3/8" hole. 0.5 Amp - 125V. Rated 130 Vdc-30mA. Contact length is 1.19". Wire length is 11".

- 40-660** Normally Closed (white wire) .75" gap
40-661 Normally Open (green wire) .5" gap
 Both with magnet in place.



40-658 oVeRheAD Do o R Co Nt Act

Heavy duty, wide gap, 24" wire leads enclosed in stainless steel cable. Closed circuit with magnet in place. 1 Amp - 125V, 130Vdc - 50mA contact rating. Contact size is 3.47" long x 1.27" wide. Wire length is 17".



40-659 FLUsh

mo UNT Co Nt Act

SPST normally closed with magnet in place. Circuit opens when magnet is removed. Recesses into 1/4" hole. Alnico magnet. 15" leads. Rating 100mA-100 Vdc, 1 Amp-10 Vdc, 10 watts max.

No mounting brackets included



40-664

ViBRAt io N s Wit Ch

Shock switch for protection of window glass, walls, showcase, etc. Normally closed circuit. Size: 2 3/8"(L) x 7/8"(W) x 9/16"(H). Contact rating .5 Amp at 25 Vdc max.



40-756 st UBBY ReCesseD

Co Nt Act

5/8" long switch for tight installations. Normally closed with magnet in place. Available in off white only. 3/8" operating gap. Rating 100mA-100 Vdc max., 1 amp-10 Vdc. Contact length is .78". Wire length is 17".



40-667 ReCesseD pLUNgeR s Wit Ch

Positive action, easy to install, tapered body for tight fit, mounts in 3/8" hole. Normally closed circuit. Adjustable plunger.



* please note that Calrad's magnetic switches are for use with alarm systems only and not voltage type circuits that exceed the contact ratings, doing so may cause the reed switch to arc closed and become defective.

CALRAD

40 series - security switches

pLAsT iC BALL pLUNgER sWit Ch

Completely environmental proof for window, door protection, etc. Mounts in 3/4" hole. Mounting centers 1 3/16". Rating 100mA-100 Vdc max., 1 Amp-10 Vdc max., 10 watts max. 30" wired leads. Overall mounting depth 1.7".

40-670 Normally Closed

40-671 Normally Open and Normally Closed contacts (Both with ball depressed.)

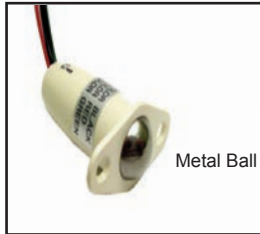

Metal Ball

40-676 Lo W pRo FiLe pLAsT iC BALL pLUNgER sWit Ch

Completely environmental proof for window, door protection, etc. Mounts in 3/4" hole. Mounting centers 1 5/16". Rating 100mA-100 Vdc max., 1 Amp-10 Vdc max., 10 watts max. Normally closed switch with 18" leads. Overall mounting depth 1". Includes .1" plastic spacer.



Plastic Ball

40-654 t AmPeR sWit Ch

SPST momentary contact. Use in conjunction with most security devices. Normally closed (with plunger depressed). Contact rating .5 Amp-50 Vdc. Size is 1.84" long x 1.09" wide.



40-652 hoLD-Up UNit

Double button operation virtually eliminates accidental triggering. Sturdy metal case, silver plated SPST contacts. Prewired for quick installation. Color beige, contacts rated for 1 Amp @25Vdc. Size is 1.99"(W) x .99"(H) x 1.74"(D).



40-758 sURFAcE moUNT

t oggLe sWit Ch
SPST toggle switch mounted in a white impact housing. Mounting centers 2.125". Overall height 2", 6" black flying leads, stripped. Chrome switch position ID label ON/OFF. Current rating 3Amps @125Vac, 50Vdc.



40-650 eMeRgEnCY pANiC

sWit Ch
3" long, 7/8" wide, 2 5/8" mounting centers. Normally open circuit. Screw terminals on the rear of switch for connection.

40-650A

Same as 40-650 only with normally open and closed options available.



40-673 pLAsT iC NYLoN hoLDeR

Used for recessed mounting of contacts and magnets on steel doors. Holds magnet or contact in place away from frame. For use with our 40-659 contact, magnet. Hole size 3/4". Color: grey.



40-672 ALUmiNum Z-BRACkEt

Needed for extending magnet greater distances when uneven surfaces exist. Used for 40-750, 751, 752. Over-all length is 8". Long tongue is 5.75" and short tongue is 2.5".



40-663A spst DoUBLE siDeD keY sWit Ches

Sometimes called a shunt lock. Complete with 2 keys and mounting hardware. Hook up using screw terminals. Used with most alarm equipment and with all Calrad Alarm Modules. 125Vac, 4Amp. 250Vac, 2A. Mounts in 1.8" deep hole. Bushing length to connectors 1.8", Mounts in .75" hole.



RoUND high seCURit Y keYLoCk sWit Ches

Mounts in 3/4" hole. 1 11/16" deep. 3 Amp - 125V.

40-682 SPST Momentary, Spring Return

40-683 SPST Shunt On/Off Solder Terminals



40-768 3/8" stUBBY ReCesseD CoNt ACt Wit h sCRew t eRmiNALS

5/8" long switch for tight installations with short mounting areas. Switch/magnet case with ribs for securing in holes, 5/16" operating gap. Closed circuit with magnet in place. Available in white only. 100mA 100Vdc max., 1A 10Vdc. Contact length is .78".



Small Slotted Screw Driver Required



40-769 3/8" ReCesseD CoNt ACt Wit h sCRew t eRmiNALS

Switch/magnet case with ribs for securing in holes, 5/8" operating gap. Closed circuit with magnet in place. Available in white only. 100mA 100Vdc max., 1Amp 10Vdc. Contact length is 1.32".



CALRAD

42 Series - IPOD Accessories



**42-100-1.5M, -2M
IPOD STEREO
INTERFACE CABLE**
Plug your iPod into your home stereo system with this 24K Gold plated Male 3.5mm plug to two L+R RCA Male plugs. Available in 1.5 meters and 2 meters.



**42-105
IPOD A/V
INTERFACE CABLE**
Connect your iPod to a TV display. Watch slide shows. Connect the A/V Cable to your stereo or powered speakers. The 3 ft. A/V Cable connects to the headphone port of the iPod or the line-out port on the iPod Universal Dock.



**42-107-RT-RT
3.5mm IPOD, IPAD
STEREO
INTERFACE CABLE**
Right angle 3.5mm stereo audio interface cable. Connects the headphone out of your iPod, iPad to the 3.5mm line input of your PC. Available in 2 feet or 3 feet lengths.



**42-107-ST-ST-3
3.5mm IPOD, IPAD
STEREO
INTERFACE CABLE**
Straight 3.5mm stereo audio interface cable. Connects the headphone out of your iPod, iPad to the 3.5mm line input of your PC. Available in 2 feet or 3 feet lengths.



**42-107-ST-RT-2,-3
3.5mm IPOD, IPAD
STEREO
INTERFACE CABLE**
Right angle to straight 3.5mm stereo audio interface cable. Connects the headphone out of your iPod, iPad to the 3.5mm line input of your PC. Available in 2 feet or 3 feet lengths.



**42-115
CONVENIENT IPOD,
IPAD USB-BASED
DATA AND POWER
ADAPTER**
Used to transfer files or charge your iPod, iPad at home, on the road. 6 ft. 24K gold plated connectors, Apple's proprietary 30-pin Male dock plug to type 'A' male USB plug.



**42-130
iPod CIGARETTE
LIGHTER CAR
CHARGER**
Plugs into any cigarette lighter jack and provides charging of your iPod player. Retractable cable with Apple's proprietary 30-pin Male dock plug, L.E.D. power and charging indicator.



**42-AC-1 USB
AC CHARGER**
Use this iPod Power Adapter for home, office or travel. This is an USB type 'A' wall charger that is used to charge your iPod, iPad, Iphone from any 110v outlet instead of always having a computer around.



**42-CAR-1 USB
SINGLE PORT
CAR CHARGER**
Power USB 12-24 dc power output, 5vdc 700ma output, 1 usb port Type 'A' Car Charger. Charge USB devices while in the car. Great for charging cell phones, cameras, Ipods, iPads.



**42-CAR-2 USB
CAR CHARGER**
Power USB 12-24 dc power output, 5vdc 700ma output, 2 usb ports Type 'A' Car Charger. Charge USB devices while in the car. Great for charging cell phones, cameras, Ipods, iPads. L.E.D. charging/power indicators.

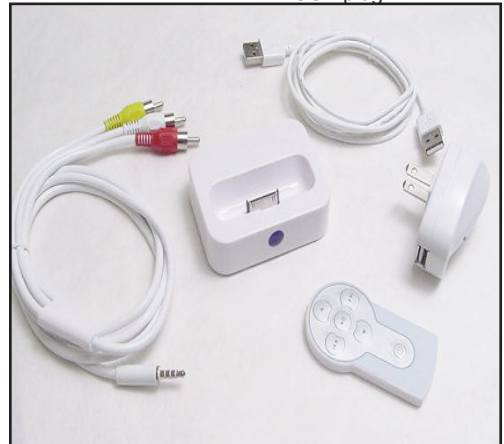

**42-160
iPod Audio/Video, IR Remote Docking Station**
The iPod photo dock is an elegant home base for charging and synching with your computer or for connecting to your home audio video system. Includes 6 button slimline IR remote with play/pause, next/previous track select, power on/off, volume - up-down, 3 ft. A/V interface cable, power supply, 5 ft. USB interface cable, docking station. Composite, S-Video, L+R analog audio outputs.



**42-165
4 WATT PORTABLE OR WALL
MOUNT IPOD AMPLIFIED SPEAKER
SYSTEM WITH IR REMOTE CONTROL**
Slim, lightweight design with an efficient 4 Watt class D stereo amplifier. Transparent and foldable cover protects your iPod. Built-in removable dock inserts for charging and using different style iPods. Infrared remote control allows you to operate your iPod for music selection, play pause, volume, power on/off. Compatible with iPod, iPod Mini, iPod Photo, iPod Nano. Rear 3.5mm aux input jack for external devices. Ac Adapter or 6 x AA batteries required for battery power.



Docking Station
Base
Connector View

45 Series - AC Adapters & Power Supplies

Technical drawings and specifications are available for these power supplies. Please ask your Calrad sales representative for details.

All DC adapters with coax power plugs are wired positive center unless specified otherwise.

All DC adapters with 3.5mm power plugs are wired tip positive unless specified otherwise.

AC TO DC ADAPTERS

- 45-754 multi plugs, 6 ft. cord, UL & CSA appStyle C.....Input 117 Vac, Output 3,4,5,6,7,5,9,12 Vdc, 800 mA
- 45-754A multi plugs, 6ft. cord , UL & CSA app.....Style C.....Input 117 Vac, Output 3,4,5,6,7,5,9,12 Vdc, 2.2 Amps
- 45-756 3.5 mm plug, 7 ft. cord, UL & CSA approvedStyle A.....Input 117 Vac, 60 Hz, Output 6 Vdc, 300 mA
- 45-757 3.5 mm plug, 7 ft. cord, UL & CSA approvedStyle A.....Input 117 Vac, 60 Hz, Output 9 Vdc, 300 mA
- 45-757-2.1 2.1 mm plug, UL & CSA approvedStyle A.....Input 117 Vac, 60 Hz, Output 9 Vdc, 300 mA
- 45-757-2.5 2.5 mm plug, UL & CSA approvedStyle A.....Input 117 Vac, 60 Hz, Output 9 Vdc, 300 mA
- 45-765 3.5 mm plug, 6 ft. cord, UL & CSA approvedStyle A.....Input 117 Vac, 60 Hz, Output 9 Vdc, 500 mA
- 45-766 3.5 mm plug, 6 ft. cord, UL & CSA approvedStyle A.....Input 117 Vac, 60 Hz, Output 9 Vdc, 1.0 Amps
- 45-746 3.5 mm plug, 6 ft. cord, UL & CSA approvedStyle A.....Input 117 Vac, 60 Hz, Output 12 Vdc, 300 mA
- 45-746-2.1 2.1 mm plug, 6 ft. cord, UL & CSA approved Style A.....Input 117 Vac, 60 Hz, Output 12 Vdc, 300 mA
- 45-761 3.5 mm plug, 6 ft. cord, UL & CSA approvedStyle A.....Input 117 Vac, 60 Hz, Output 12 Vdc, 500 mA
- 45-761-2.1 2.1 mm plug, UL & CSA approvedStyle A.....Input 117 Vac, 60 Hz, Output 12 Vdc, 500 mA
- 45-763 3.5 mm plug, 6 ft. cord, UL & CSA approved.Style A.....Input 117 Vac, 60 Hz, Output 12 Vdc, 800 mA
- 45-763-2.5 2.5mm coax plug, 6 ft. cord,UL & CSA app.....Style A.....Input 117 Vac, 60 Hz, Output 12 Vdc, 800 mA
- 45-763-S 2.5 mm coax plug, 6 ft. cord, UL & CSA app.....Style A. Input 117/220 Vac,60 Hz,Output 12 Vdc, 800 mA
- 45-751 2.1mm coax plug, 6 ft. cord, UL & CSA app.....Style A.....Input 117 Vac, Output 12 Vdc, 1.2 Amps
- 45-772 3.5 mm plug, 6 ft. cord, UL & CSA approvedStyle A.....Input 117 Vac, 60 Hz, Output 18 Vdc, 200 mA
- 45-773 2.1mm coax plug, 6 ft. cord, UL & CSA app.....Style A.....Input 117 Vac, Output 18 Vdc, 500 mA
- 45-767 3.5 mm plug, 6 ft. cord, UL & CSA approvedStyle A.....Input 117 Vac, 60 Hz, Output 24 Vdc, 400 mA
- 45-767-2.1 2.1 mm plug, 6 ft. cord, UL & CSA approved Style A.....Input 117 Vac, 60 Hz, Output 24 Vdc, 400 mA
- 45-762 2.1mm plug, 6 ft. cord, UL & CSA app.....Style A.....Input 120 Vac, Output 24 Vdc, 600 mA

Please note plug changes are available for most power supplies but this action negates the UL rating. Please contact your Calrad Representative for details

AC TO AC ADAPTERS

- 45-776 2.1mm coax plug, 6 ft. cord, UL & CSA approved Style A.....Input 117 Vac, Output 9 Vac, 1 Amps
- 45-776-2.5 2.5mm coax plug, 6 ft. cord, UL & CSA approved Style A.....Input 117 Vac, Output 9 Vac, 1 Amps
- 45-768 3.5mm plug, 6 ft. cord, UL & CSA app.Style A.....Input 117 Vac, Output 12 Vac, 830 mA
- 45-768-2.5 2.5mm coax plug, 6 ft. cord, UL & CSA app. Style A.....Input 117 Vac, Output 12 Vac, 830 mA
- 45-775 screw terminals, UL approvedStyle B.....Input 117 Vac, Output 12 Vac, 3.3 Amps
- 45-775-50 screw terminals, UL approved.....StyleB.....Input 117Vac, Output 12 Vac, 2 Amps
- 45-760 screw terminals, UL approvedStyle D.....Input 117 Vac, Output 16 Vac, 700 mA
- 45-764 2.1mm coax plug, 6 ft. cord, UL & CSA app.....Style A.....Input 117 Vac, Output 16 Vac, 1.1 Amps
- 45-777 screw terminals, UL approvedStyle B.....Input 117 Vac, Output 16 Vac, 2.5 Amps
- 45-774 screw terminals, UL approvedStyle B.....Input 117 Vac, Output 24 Vac, 1.6 Amps
- 45-774-50 screw terminals, UL approved.....Style B.Input 117 Vac Output 24 Vac, 2 Amps

Case style may vary on AC adapters

Style

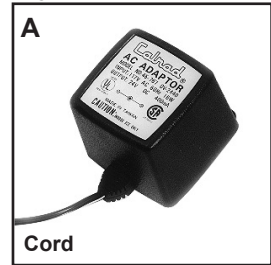

Cord

Style



Screw Terminals

Style

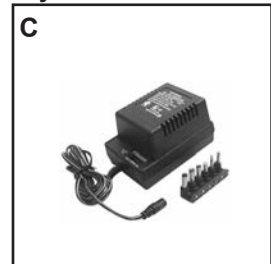

Style



Screw Terminals



2.1 coax plug



2.5 coax plug



3.5 coax plug



MULTI PLUGS



SCREW TERMINALS

CALRAD

45 Series - AC Adapters & Power Supplies

45-769

11.5 VOLT DC, 1.95 AMP DESK TOP POWER SUPPLY

For use with personal computers, TV games, printers, communications, etc. Input 117Vac (60 Hz). UL and CSA approved.

AC cord is 5ft. and DC 6ft. cord

Specifications

Dimensions:.....2³/₁₆" W x 3³/₁₆" H x 2³/₁₆" D
Power Plug2.1 mm coax
Color..... Black



45-752A

12Vdc REGULATED WALL MOUNT POWER SUPPLY

Plugs directly into standard 117Vac wall outlet. Non-UL approved version of 45-752. Comes with screw terminals. 12Vdc, 1.2 Amps regulated.

Specifications

Dimensions ... 2⁵/₁₆" W x 3³/₄" H x 2¹/₄" D
Color..... Black



Screw Terminals

45-753A

117VAC MULTI-VOLTAGE AC ADAPTER

117Vac Switch with (7) Voltage options: 500 mA. output. 117Vac. input. 3V, 4.5V, 6V, 7.5V, 9V, 12V. DC. Polarity switchable with 6 plug options of 3.5mm, 1.3mm X 3.5mm, 1.7mm x 4.0mm, 2.1mm X 5.5mm, 2.5mm X 5.5mm, 1.75mm X 4.75mm. UL & CSA approved. 6ft. cord length.

Specifications

Dimensions ...2.1"W x 3.05" H x 2.05"D
Color..... Black



WALL MOUNT REGULATED SWITCH MODE POWER SUPPLY

45-601 12Vdc, 1.5A

Operates from 110Vac to 220Vac automatically switches for each voltage. Output 12Vdc regulated at 1.5 Amps. 6ft cord. Short circuit/over, voltage protection.

Specifications:

Dimensions 3" L x W 1.35" W x H 1.76"
Power Plug2.1mm coax
Color..... Black



45-753

Same as 45-753A but with different plug options. Comes with 2.5mm, 3.5mm, 9V Battery Snap, 5.5mm x2.5mm, 5mm x 2.1mm, 3.5mm x 1.3mm coax plugs



45-753

DESKTOP REGULATED SWITCH MODE POWER SUPPLY

These units operate on 110Vac to 220Vac and automatically switches for each voltage. 6ft. IEC cord included.

45-602 12Vdc, 2.5A

Output 12Vdc regulated at 2.5 Amps. 6ft cord. Short circuit/over, voltage protection.



45-603

45-755 UNIVERSAL SWITCHING ADAPTER REGULATED DC POWER SUPPLY

Switching regulator circuit. Light weight design. Adjustable slide switch voltage selector with 3, 4.5, 6, 7.5, 9, and 12Vdc. Over/under voltage protection. Short circuit protection. Input voltage of 100-120Vac. Output current 1A. 6ft cable length. Color: black. Plug sizes: 2.35x0.7mm mini, 3.5x1.35mm coax, 4x1.75mm coax, 4.74x1.75mm coax, 3.5mm Male, 5.5x2.1mm coax, and 5.5x2.1mm coax.



45-603 12Vdc, 4.1A

Output 12Vdc regulated at 4.1 Amps. 6ft cord. Short circuit/over, voltage protection.



45-611

45-611 24Vdc, 1.2A

Output 24Vdc regulated at 1.2 Amps. 6ft cord. Short circuit/over, voltage protection.

Specifications:

Dimensions ... 2.93"W x 1.25"H x 5.1"L
Power Plug, 2.1mm coax
Color..... Black

45-752

12 VOLT DC REGULATED 1.2 AMP ADAPTER-WALL MOUNT

Plugs directly into standard 117Vac wall outlet, solid state, IC regulated.

6 ft. cord with 2.1 x 5.5mm coax plug, UL approved.

Specifications

Dimensions3¹/₁₆" W x 4³/₄" H x 2³/₁₆" D
Color..... Black



72-350 KEYSTONE 2.1mm DC POWER JACK TO SCREW TERMINALS

Labeled (+, -) screw terminals. Accepts up to 18 Awg wire. Overall depth 1.4".

Color: Black



45 Series - AC-DC Adapters, Power Supplies

45-840

DC POWER SUPPLY FOR CCTV AND ACCESSORIES

Total maximum supply current at 12Vdc and each channel output is fused at 1.1 Amps. This DC power supply centralizes the power sources for multiple DC powered CCTV cameras and/or accessories. The power input, power transformer, D regulator and all independently-fused power outputs are enclosed in one heavy duty easy to install metal enclosure.

Specifications:

Power:
 Input: 120Vac, 60Hz,
 Adjustable Vdc Output: 9 Outputs @ 6/12/24Vdc
 UL Approved Power Transformer
 Main Fuse Rated 5.0 Amps @ 250Vac
 Spare Fuse Included
 6ft Power Cord



45-650 UL LISTED UN-REGULATED MINIATURE POWER ADAPTERS

The mini adapter is available in output voltages from 3Vdc to 24Vdc, 117Vac in. These power supplies offer high efficiency and are very small for the amount of output current. Short circuit/over voltage protection. 6ft cord with 2.1mm coax plugs, positive center. Other plug types and configurations available, ask your Calrad representative for details. Weight 36 grams. Size: .88" d x 1.8"H x 1.3"W.

45-650-3	3Vdc.....	.6A
45-650-4.5	4.5Vdc.....	.8A
45-650-6	6Vdc.....	1A
45-650-7.5	7.5Vdc.....	1.2A
45-650-9	9Vdc.....	1.2A
45-650-12	12Vdc.....	1.2A
45-650-15	15Vdc.....	1.2A
45-650-18	18Vdc.....	1A
45-650-24	24Vdc.....	.8A

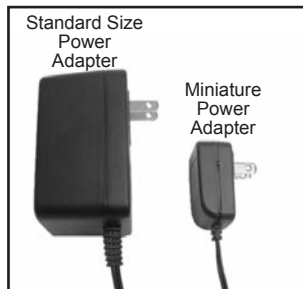

45-606

Universal Laptop Power Supply

Power your laptop or LCD monitor. Selectable power outputs from 12Vdc to 24Vdc. Built in USB port allows you to charge your USB devices. Comes with 8 DC adapter plugs. LED voltage indicator. Overload and short circuit protection



45-607

12Vdc version with cigarette lighter adapter

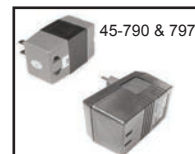

PORTABLE TRAVEL TRANSFORMERS

Travel transformers for use throughout the world, small and lightweight.

45-790 .. in 117Vac - 100 Vac, 100 Watts	45-797in 220Vac - 110Vac, 55 Watts
45-791 .. in 100Vac - 117 Vac, 60 Watts	45-798 in 220Vac - 110Vac, 100 Watts
45-795 .. in 220Vac - 110 Vac, 50 Watts	45-799in 220Vac - 110Vac, 1600 Watts
45-796 .. in 110Vac - 220 Vac, 50 Watts	

AC PLUG ADAPTERS

Travel plug adapters for use throughout the world. Ask Calrad for a requirements chart for the countries.



45-810
 220Vac to 110Vac AC polarized USA Female Plug



45-811
 110Vac to 220Vac AC Plug



45-812
 Australia to polarized USA Female and Europe.



45-813
 USA to UK, 15 Amp. Europe.



45-815
 UK to USA or Europe.



45-816
 German Plug to USA Jack, 9 1/2" overall. Grounded.



45-817
 UK Plug to USA Jack, 7 1/2" overall. Grounded.



45-818
 All countries input to 2 prong European output.

CALRAD

45 Series Battery Chargers, Transformers

45-758 3 AMP REGULATED BATTERY CHARGER & POWER SUPPLY

For alarm system power and automatic recharging of back-up batteries. LED power indicator, 2.5 Amps continuous and 3 Amps peak power. Input 16Vac to programmable output 6/12/24Vdc. Fuse protected. Comes with battery leads. 6 Position Barrier Strip. Mounts with double stick tape.

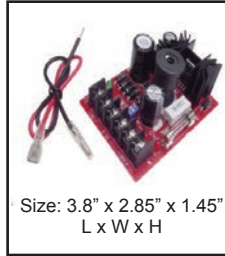

Size: 3.8" x 2.85" x 1.45"
L x W x H

45-759 1.2 AMP REGULATED CHARGER BOARD ONLY

16Vac in, 12Vdc out. Fuse protected. 4 Position Barrier Strip, for alarm system power and automatic recharging of back-up batteries. Fuse protected. Mounts with double stick tape.

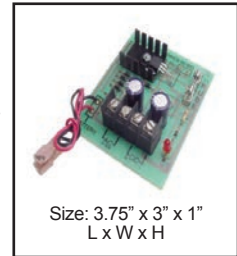

Size: 3.75" x 3" x 1"
L x W x H

45-728 6-VOLT FILAMENT TRANSFORMER

Primary 117 volts AC, secondary 6.3 Volts C.T. 1.5 Amps. Mounting centers 2³/₈". Size: 2" x 1⁵/₈" x 1⁵/₈" high. With wire leads. Weight is 12.8 oz.

45-716 6-Volt Filament Transformer. Primary 117 Volts AC, secondary 6.3 Volts AC 0.4 Amps



45-728

* 45-720 or 45-720L (5-25V) 45-722 or 45-722L (10-25V) 5 AND 10 WATT, 25 VOLT MATCHING LINE TRANSFORMERS (SPECIFY WITH OR WITHOUT LEADS)

Universal 25 Volt 5 & 10 Watts audio line transformers for chassis or speaker mounting. Can be connected to an audio amplifier to enable proper line and speaker impedance. Matches 4 to 8 ohm speakers. Taps of 0.312, 0.625, 1.25, 2.5, 5 Watts for the 45-720. Taps of 0.625, 1.25, 2.5, 5, 10 Watts for the 45-722. Weight for 45-720 is 6.5 oz. Weight for 45-722 is 10.4 oz.

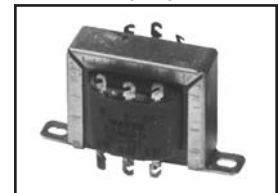

* 45-721 or 45-721L (5-70V) 45-723 or 45-723L (10-70V) 5 AND 10 WATT, 70 VOLT MATCHING LINE TRANSFORMERS (SPECIFY WITH OR WITHOUT LEADS)

Universal 70 Volt 5 & 10 Watts audio line transformer for chassis or speaker mounting, can be connected to an audio amplifier to enable proper line and speaker impedance. Matches 4 to 8 ohm speakers. Taps of 0.31, 0.62, 1.25, 2.5, 5 Watts for the 45-721. Taps of 0.625, 1.25, 2.5, 5, 10 Watts for the 45-723. Weight is 9.6 oz.

45-720, 721, 722, 723, 726, & 727 Without leads.

* 45-726 or 45-726L 10 WATT, 25 VOLT, 70 VOLT COMBINATION LINE TRANSFORMER (SPECIFY WITH OR WITHOUT LEADS)

Taps of .65, 5, 10 Watts at 25 Volt. Taps of 0.25, 1.25, 5 Watts at 70 Volt. Weight is 10.5 oz.



* 45-727 or 45-727L 30 WATT MATCHING LINE TRANSFORMER (SPECIFY WITH OR WITHOUT LEADS)

Taps of 10, 20, 30 Watts at 25 Volt. Taps of 10, 20, 30 Watts at 70 Volt. Weight is 10.2 oz.

45-720L, 721L, 722L, 723L, 726L, & 727L With leads.

MINI TRANSISTOR AUDIO TRANSFORMERS

Ideally suited and selected for building or replacement of transistorized equipment. High vacuum impregnation, application of a special coating seals the coils. A special core of hydrogen heat-treated alloy is used.

Size ³/₄" x ⁵/₈" x ⁵/₈". Frequency Response: +/- 3dB, 20-25KHz. Specify Part No.

Part. No.	Type	Primary Ohms	Primary DC Res.	Secondary Ohms	Secondary DC Res.	Max Power Rating
45-700	Input	100,000	2K	1000	70 Ω	100mW
45-701	Output	1200	60Ω	3.2	.4Ω	100mW
45-703	Mic Input	200,000	2.26K	1000	43Ω	100mW
45-705	Input	20,000	320Ω	1000	230Ω	100mW
45-707	Driver	10,000	700Ω	2000 C.T.	127Ω	100mW
45-709	Output	500 C.T.	35Ω	3.2	.27Ω	100mW
45-711	Output	1000 C.T.	53.1Ω	8	.57Ω	100mW
* 45-715	Input	500Ω	34Ω	50 KΩ	3.17KΩ	100mW



Same as above except sub-miniature, type. Size ¹/₂" x ¹/₂" x ¹/₂". Specify Part No.

45-702	Input	100,000	1K	1000	110Ω	75mW
45-704	Output	500 C.T.	35.5Ω	3.2	.4Ω	75mW
45-706	Input	200,000	1.6K	1000	118Ω	75mW
45-708	Driver	10,000	736Ω	2000 C.T.	173Ω	75mW
45-710	Output	500 C.T.	32Ω	8	2Ω	75mW

* DENOTES SPECIAL ORDER ONLY

45 Series - Transformers, DC Power Adapters

Technical drawings and specifications are available for these power supplies. Please ask your Calrad sales representative for details.

MINI TRANSISTOR AUDIO TRANSFORMERS FOR PRINTED CIRCUIT BOARD MOUNTING

Ideally suited and selected for building or replacement of transistorized equipment. High vacuum impregnation and application of a special coating seals the coils. A special core of hydrogen heat treated alloy is used to give high quality at a low cost. Dimensions $\frac{3}{4}$ " x $\frac{5}{8}$ " x $\frac{5}{8}$ ". Frequency Response: \pm 3dB, 20-25KHz.

Part No.	Type	Primary Ohms	Primary DC Res.	Secondary Ohms	Secondary DC Res.	Max Power Rating
45-712	Driver	10,000	400 Ω	2000 C.T.	100 Ω	200mW
45-713	Output	500 C.T.	30 Ω	3.2	.4 Ω	200mW
45-714	Output	1000 C.T.	45 Ω	8	.4 Ω	200mW

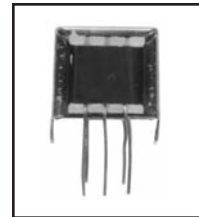

45-698 TRANSFORMER

600 Ω –600 Ω Isolation Transformer–Wire Leads.
Primary DC Resistance – 47W. Secondary DC Resistance – 60 Ω .
Frequency Response of \pm 3dB, 20-25KHz. Size: $\frac{1}{2}$ " x $\frac{1}{2}$ " x $\frac{1}{2}$ "
Max Power Rating: 75mW.

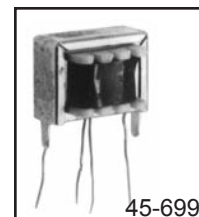

45-699 TRANSFORMER

600 Ω –600 Ω Isolation Transformer–P.C. Leads.
Primary DC Resistance – 47 Ω . Secondary DC Resistance – 60 Ω .
Frequency Response of \pm 3dB, 20-25KHz. Size: $\frac{1}{2}$ " x $\frac{1}{2}$ " x $\frac{1}{2}$ "
Max Power Rating: 75mW

45-748 DC TO DC MULTI-CONVERTER FOR CARS

12 Vdc. input to 3V, 4.5V, 6V, 7.5V, 9V, 12V at 800 mA output. Polarity switchable with multi plugs. Regulated. Fuse protected at 2 Amps. Cigarette lighter plug on 6" cable. Output cable is 5 ft. Color: black. Plug sizes: 3.5mm, 1.1 x 2.5mm, 2.5 x 5.5mm, 1.35 x 3.5mm, 1.7 x 4.0mm, 2.1 x 5.5mm.



45-749 DC TO DC MULTI-CONVERTER FOR CARS

12 Vdc. input to 3V, 4.5V, 6V, 7.5V, 9V, 12V at 2 amp output. Polarity switchable with multi plugs. Fuse protected at 2 Amps. Cigarette lighter plug on 5 ft. cord. Output cable is 1 ft. Color: black. Plug sizes: 3.5mm, 1.1 x 2.5mm, 2.5 x 5.5mm, 1.35 x 3.5mm, 1.7 x 4.0mm, 2.1 x 5.5mm.



45-820 LIGHTER PLUG

Fused lighter plug with 6 detachable plugs. 12 ft. coiled cord with multi plugs on the other end. Fuse protected at 2 Amps.



45-821 LIGHTER PLUG

Fused lighter plug with LED indicator. 6 ft. cord with 2.1mm right angle coax plug on the other end. Fuse protected at 5 Amps. With positive center.



45-824 UL APPROVED AC POWER CORD

Polarized AC power cord with square/round end with two slots for use with many portable audio and video equipment.



45-822 UL APPROVED AC POWER CORD

Polarized AC power cord with round/round end with two slots for use with many portable audio and video equipment. Length 6ft..



CALRAD

45 Series - Variacs & AC Power Cords

45-740

VARIABLE OUTPUT VOLTAGE REGULATOR

Adjustable output from AC line, 0 to 130 Volts. Input 117 Volts, 5 Amps. Current rating apply over full range of output voltage.

Specifications:

Dimensions.....6 1/2" diameter (Including Terminals)
5 1/2" deep (Knob to Base)
Weight..... 9.2 lbs.



45-741

VARIABLE OUTPUT VOLTAGE REGULATOR

5 amp isolated supply w/ volt meter. Fuse protected with On/Off switch and AC volt meter scale 0-150 Vac.

Specifications:

Input Voltage..... 110-120 Vac
Dimensions..... 5"W x 6 1/2"H x 6 1/4"D
Output Voltage ... 0-130 Vac, adjustable
Weight..... 10 lbs.



55-780

AC POWER CABLE

3-Prong, extra heavy duty AC cord. Round 16 gauge wire has stripped and tinned ends. (6 ft. long—Black). UL and CSA approved.

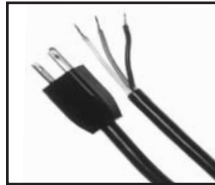

AC COMPUTER POWER CABLES

- 55-782-1 1 ft.
- 55-782-1.5 1.5 ft.
- 55-782-2 2 ft.
- 55-782-3 3 ft.
- 55-782-6 6 ft.
- 55-782-12 12 ft.

3-Prong IEC computer cable. Has grounded AC plug on one end and computer plug on other end. (18 gauge, Black).



(RIGHT ANGLE)

AC COMPUTER POWER CABLES

- 55-782RT-1.5 18 Inches
- 55-782RT-3 3ft.
- 55-782RT-6 6ft.
- 55-782RT-12 12ft.

3-Prong AC computer cable. Right Angle, three pin AC plug to computer jack on other end. 18 gauge, Black.



55-781

3 PRONGED FEMALE TO IEC AC MALE ADAPTER

UL listed, IEC Male plug to 3 prong grounded Female inline jack. 6" long, Black.



55-784

AC POWER CABLE

2-Prong, AC Replacement Cable Wire. Heavy Insulation. 18 gauge, 6 ft. long, color is black.

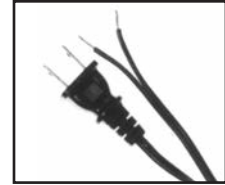

55-788A

18 INCH DUAL POWER STRIP TRANSFORMER SPACE ELIMINATOR CABLE

The Cure for Wall Warts on Electrical Power Strips. 3-Prong AC extension cable. Has AC plug on one end and AC jack on the other end. (UL listed, 18 gauge).



55-788B

POWER STRIP TRANSFORMER SPACE ELIMINATOR WITH A.C. FEEDTHROUGH PLUG

55-788, 6 Inch

55-788-1, 1 ft.

POWER STRIP TRANSFORMER SPACE ELIMINATOR CABLE

The Cure for Wall Warts on Electrical Power Strips. 3 Prong AC extension cable. Has AC plug on one end and AC jack on the other end. (UL listed, 18 gauge). Available in 6 inch and 1 ft.



55-783

AC EXTENSION CABLE

3-Prong AC computer extension cable. Has AC plug on one end and computer jack on other end. (18 gauge, 6 ft. long, Black).



55-785-3 3 ft.

55-785-6 6 ft.

RIGHT ANGLE POWER CABLE

Right angle 3-prong AC computer cable. Has AC plug on one end and right angle computer IEC plug. 18 gauge, 6 ft. long, color is black.

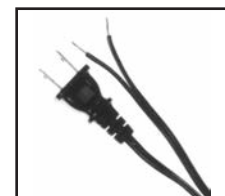

55-782RT WHITE AC CABLES

For use with Plasma, LCD, DLP and Monitors. Shielded design reduces RF/EMI interference. Female IEC to right angle AC Male. 10 Amps 125Vac 18 Gauge 3 conductor. UL and FT2 approved.

55-782RT-6-SHG 6 ft.

55-782RT-12-SHG 12 ft.

55-782RT-25-SHG 25 ft.



CALRAD

45 Series - Power Inverters

DC to AC POWER INVERTERS

Car cigarette plug power inverters. Now you can operate most AC appliances such as camcorders, computers, fax machines and portable TVs from the DC current of your car's battery. This unit is fully portable and gives you a standard AC outlet wherever your car is. These units plug into a cigarette plug and changes your car's DC into AC by using a Modified Sine Wave. Grounded AC outlets. Units come with low battery alarm and auto shutdown.

Overload and short circuit protection. Input polarity reverse protection by fuse. High surge current capability makes it easy to start TV, motors and other inductive loads.

45-900 DC to AC POWER INVERTER 80 WATTS

Changes DC to AC power, cigarette lighter plug style. Comes with illuminated On/Off switch and single 3 prong AC outlet.

SPECIFICATIONS:

Input:.....	12 Vdc	Efficiency:.....	90%
Output:.....	115 Vac	Fuse.....	10 Amps
Continuous Power.....	80 Watts	Weight.....	.60 lbs
Peak Power:.....	150 Watts	Dimensions.....	4.5" x 2.35" x 1.37" (LxWxH)



45-901 DC to AC POWER INVERTER 100 WATTS

Comes with illuminated On/Off switch, single 3 prong AC outlet and 6 ft. cord.

SPECIFICATIONS:

Input:.....	12 Vdc	Efficiency:.....	90%
Output:.....	115 Vac	Fuse.....	20 Amps
Continuous Power.....	100 Watts	Weight.....	1.1 lbs
Peak Power:.....	200 Watts	Dimensions.....	6.9" x 2.95" x 1.57" (LxWxH)



45-902 DC to AC POWER INVERTER 150 WATTS

Comes with illuminated On/Off switch, single 3 prong AC outlet and 6 ft. cord.

SPECIFICATIONS:

Input:.....	12 Vdc	Efficiency:.....	90%
Output:.....	115 Vac	Fuse.....	20 Amps
Continuous Power.....	150 Watts	Weight.....	1.1 lbs
Peak Power:.....	300 Watts	Dimensions.....	6.1" x 2.75" x 1.57" (LxWxH)



45-903 DC to AC POWER INVERTER 300 WATTS

Comes with illuminated On/Off switch, dual 3 prong AC outlets and 6 ft. cord.

SPECIFICATIONS:

Input:.....	12Vdc	Efficiency:.....	90%
Output:.....	115Vac	Fuse.....	30 Amps
Continuous Power.....	300 Watts	Weight.....	0.8 kg
Peak Power:.....	600 Watts	Dimensions.....	5.9" x 4.13" x 1.77" (LxWxH)



45-904 DC to AC POWER INVERTER 500 WATTS

Comes with illuminated On/Off switch, three 3 prong AC outlets and 18 inch battery terminal leads for both unit and car.

SPECIFICATIONS:

Input:.....	12Vdc	Efficiency:.....	90%
Output:.....	115Vac	Fuse.....	30 Amps x 2
Continuous Power.....	500 Watts	Weight.....	1.1 kg
Peak Power:.....	1000 Watts	Dimensions.....	7.90" x 5.1" x 2.35" (LxWxH)



45-905 DC to AC POWER INVERTER 1000 WATTS

Comes with illuminated On/Off switch, three 3 prong AC outlets and 18 inch battery terminal leads for both unit and car.

SPECIFICATIONS:

Input:.....	12Vdc or 24Vdc	Efficiency:.....	90%
Output:.....	115Vac	Fuse.....	30 Amps x 3
Continuous Power.....	1000 Watts	Weight.....	1.95 kg
Peak Power:.....	2000 Watts	Dimensions.....	10.45" x 5.9" x 2.35" (LxWxH)



CALRAD

45 Series - Transformers, Power Supplies

STEP-UP/ DOWN TRANSFORMERS

PORTABLE STEP-DOWN TRANSFORMERS

Can be reversed for use as step-up transformers. No isolation from primary to secondary.

- | | |
|---|---|
| 45-780 220 Vac - 110 Vac, 50 Watts | 45-792 117 Vac or 100Vac, 500 Watts
Cord in on 117 Vac side |
| 45-781 220 Vac - 110 Vac, 100 Watts | |
| 45-782 220 Vac - 110 Vac, 200 Watts | 45-793 117 Vac or 100 Vac, 950 Watts |
| 45-783 220 Vac - 110 Vac, 300 Watts | 45-801 220 Vac - 110 Vac, 1300 Watts
220-110 only cord in on 220 side |
| 45-784 220 Vac - 110 Vac, 500 Watts | |
| 45-786 220 Vac - 110 Vac, 2000 Watts
grounded binding post for input and output | |
| 45-787 220 Vac - 110 Vac, 3000 Watts
with binding post for input and output | |



PORTABLE STEP-DOWN TRANSFORMERS

Can be reversed for use as step-up transformers. No isolation from primary to secondary.

Switchable - has both 220 & 110 sockets. Comes with grounded socket with an ON/OFF switch and a 5A, 5mm x 20mm fuse. Weight is 19 lbs.

- | | |
|---|--|
| 45-781A 220 Vac - 110 Vac, 100 Watts | 45-783A 220 Vac - 110 Vac, 300 Watts |
| 45-782A 220 Vac - 110 Vac, 200 Watts | 45-784A 220 Vac - 110 Vac, 500 Watts |
| | 45-785A 220 Vac - 110 Vac, 1000 Watts |

Size: 13.75" d x 7.5" h x 9" w



45-734 MULTI-VOLTAGE 2 AMP REGULATED POWER SUPPLY

Binding post on the output comes with a 6 ft. cord with six detachable plugs. Comes with ON/OFF switch.

Specifications:

- | | |
|------------------|----------------------------|
| Size..... | 3.5" W x 3" H x 5.5" D |
| Input..... | 120 Vac, 60hz |
| Fuse..... | 0.5 Amp |
| Voltage Out..... | 3, 4.5, 6, 7.5, 9, 11.5Vdc |
| Weight..... | 3.4 lbs. |



45-742A 0-30Vdc 5 AMP REGULATED DIGITAL POWER SUPPLY

Both Amps and Volts are variable. Complete with ON/OFF switch. Uses 3 Amp fuse and is short circuit protected.

Specifications

- | | | |
|------------------------------|---------------------------------|-------------------------|
| Load Regulation at 1%..... | 20-30V Voltage Regulation | 1% max, input |
| Load Regulation at 1.5%..... | 10-20V Output | 115-120V rated load |
| Load Regulation at 2%..... | 0-10V Current Limiter | Adjustable |
| Weight | 13.4 lbs. Size | 9" W x 4.5" H x 10.5" D |



45-778 10 AMP REGULATED SWITCHING POWER SUPPLY

This state-of-the-art power supply gives increased power handling. This new technology gives increased power handling and efficiency at low heat dissipation. Built-in over load and over voltage protection. 6ft. AC cord.

Specifications:

- | | | |
|------------------------------------|-------------------------------|---|
| Size: 5.5" L x 6" W x 3.25" H..... | Ripple | 75 mV at 80% load; Max output ripple 200 mV |
| Input | 105-128 Vac..... | Switching Frequency |
| Output..... | 13.8 Vdc..... | Line Regulation Output..... |
| Output Current..... | 10A (surge 12A)..... | Operating Temperature |
| Over Voltage | Short Circuit Protection..... | Weight |
| | | 3.3 lbs. |



45-739 300 WATT ISOLATION TRANSFORMER

Isolation between different electrical circuits. Front panel On/Off switch. Power LED indicator. 6ft. AC cord.

Specifications:

- | | |
|---------------|-------------------------|
| Wattage | 300 Watts |
| Size | 4.25"W x 3.5"H x 6.25"D |
| Weight | 7.5 lbs. |

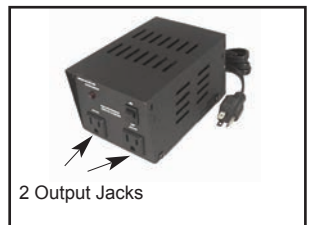

CALRAD

55 Series - Easy Install HDTV Cables

Technical drawings and specifications are available for these cables. Please ask your Calrad sales representative for details.

350 MHz EZ-HDTV / VGA CABLES

Installing a 15 pin HDTV cable in a wall or conduit just became much easier. No more on-site cable prep or connector soldering. Just snake and plug, it's that EZ.

Supports PC Plug and Play

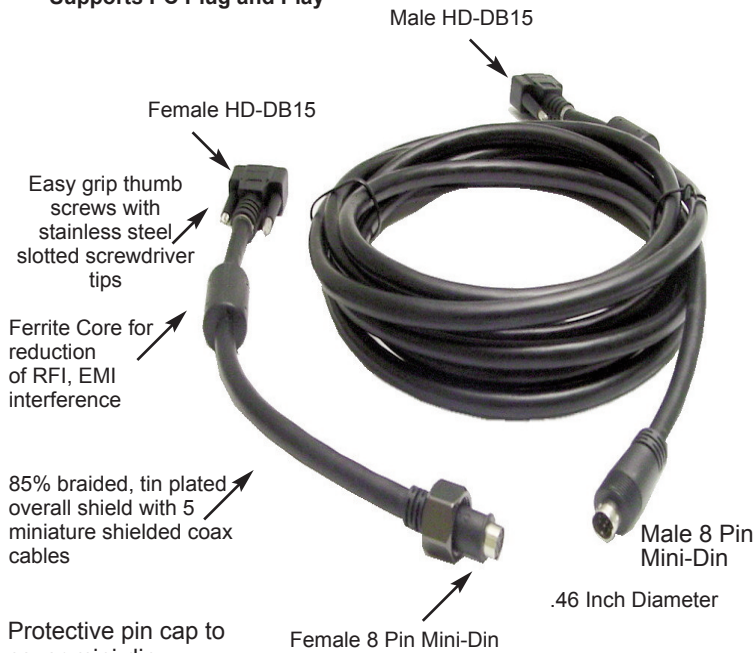

Protective pin cap to cover mini-din connector when fishing the cable

ALL PIGTAILS SOLD SEPARATELY

No heat shrink here, solid molded strain relief for strong cable termination



This Keystone feed-thru jack can be used to pass HDTV, SVGA etc. through a decora wall plate using a single keystone port. Calrad part number 72-304-8-COLOR, Red, Black, White, Ivory, Green, Blue, Yellow, Orange or Purple color options available. Requires one 55-614-EI-Length-PP and one 55-614-EI-12-PP cable to work



1 Foot Pigtail

55-614-EI-HD15FPP
Female HD-DB15 to 8 Pin Female Mini Din

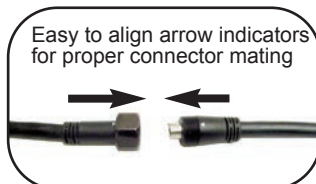

Easy to align arrow indicators for proper connector mating

NEW PLUG N PLAY DESIGN EASY INSTALL CABLE

Engineered for video excellence. Our easy install (EI) cables are suitable for passing the cable through 1/2" conduit or similar small openings. The specifications of this cable are ideal for critical or long runs, even with HDTV signals. Perfect for HDTV, Home Theater PCs, Video Amplifiers, Scalers and any situation where signal quality should not be compromised. This cable enables your equipment to reproduce the best color saturation, black level, and picture detail possible. Our cable construction features five tin-plated, individually shielded 75 ohm mini coax cables. This design insures the critical horizontal and vertical sync timing signals accurately pass from one end of the cable to the other. Since the signal is split into red, green and blue primary colors and then reassembled, the signals must arrive at the same time at the destination. The more the timing variance, the less detail can be resolved in the resulting picture. Calrad guarantees a maximum timing variance of 3 nanoseconds per 100 feet of cable. Our high quality HD-DB15 and 8 pin mini din connectors provide solid low resistance pin-pin signal path terminations. Male to Male and Male to Female plus RCA and BNC versions available.

Lengths Available

55-614-EI-12-PP	12 ft.
55-614-EI-15-PP	15 ft.
55-614-EI-25-PP	25 ft.
55-614-EI-35-PP	35 ft.
55-614-EI-50-PP	50 ft.
55-614-EI-75-PP	75 ft.
55-614-EI-100-PP	100 ft.

RCA, BNC OR VGA PIGTAIL ADAPTERS

Need something besides VGA Male to Female. Adapt your cable to fit your needs with one of three alternative pigtail ends. Available in either VGA, RCA or BNC Male configurations, these pigtails give our 55-614-EI-PP the adaptability needed in today's complex audio & video market. All adapters are 1 foot in length with molded ends. **Adapters sold separately**



55-614-EI-HD15P
Male HD-DB15 to 8 Pin Female Mini Din



55-614-EI-RCAPP
5 RCA Molded Males to 8 Pin Female Mini Din



55-614-EI-BNCP
5 BNC Molded Males to 8 Pin Female Mini Din



Use Calrad 30-588 gender changer to convert the Female HD-DB15 connector on the 55-614-EI-PP cable to a Male HD-DB15. (not included)

EZ Plenum Version Available 55-614P-EI-Length-PP
Contact Calrad for Details

CALRAD

55 Series - Component Video Cables

55-873 SHIELDED RGB VIDEO CABLES

Used to connect HDTV satellite receivers to HDTV with RGB inputs. Both styles utilize HD15 Male connectors with either RCA or BNC RGB Male ends. Overall cable O.D. .37". Mini 75 ohm coax cable O.D. .1".

Male HD15 to 3 RCA Males

55-612-SP.....	1 ft.
55-873-RCA-3.....	3 ft.
55-873-RCA-6.....	6 ft.
55-873-RCA-12.....	12 ft.
55-873-RCA-20.....	20 ft.
55-873-RCA-25.....	25 ft.
55-873-RCA-35.....	35 ft.
55-873-RCA-50.....	50 ft.

Male HD15 to 3 BNC Males

55-873-BNC-3.....	3 ft.
55-873-BNC-6.....	6 ft.
55-873-BNC-12.....	12 ft.
55-873-BNC-20.....	20 ft.
55-873-BNC-25.....	25 ft.

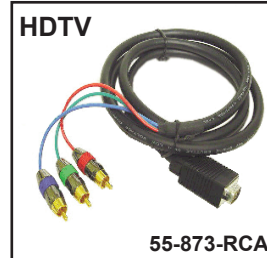

55-866 SVGA/HDTV SHIELDED VIDEO COMPUTER CABLE

15 Pin HD Male to (75 Ohm) 5 BNC (Male or Female) or RCA Male nickel plated connectors. RGB video + Sync. color coded cables. Overall cable O.D. .37". Mini 75 ohm coax cable O.D. .1".

Male HD15 to 5 BNC Males

55-866-1.....	1 ft.
55-866-3.....	3 ft.
55-866-6.....	6 ft.
55-866-10.....	10 ft.
55-866-12.....	12 ft.
55-866-15.....	15 ft.
55-866-20.....	20 ft.
55-866-25.....	25 ft.
55-866-35.....	35 ft.
55-866-50.....	50 ft.
55-866-100.....	100 ft.

Male HD15 to 5 RCA Males

55-866-RCA-1.....	1 ft.
55-866-RCA-3.....	3 ft.
55-866-RCA-6.....	6 ft.
55-866-RCA-12.....	12 ft.
55-866-RCA-15.....	15 ft.
55-866-RCA-20.....	20 ft.
55-866-RCA-25.....	25 ft.
55-866-RCA-35.....	35 ft.
55-866-RCA-50.....	50 ft.



Female HD15 to 5 BNC Males

55-866F-3.....	3 ft.
55-866F-6.....	6 ft.
55-866F-10.....	10 ft.
55-866F-12.....	12 ft.
55-866F-25.....	25 ft.



55-622 SHIELDED RGB/HV CABLE MOUNTED IN A STAINLESS STEEL WALL PLATE

DB15HD Female to 5 BNC Females. Premium breakout cable allows direct conversion of 5 BNC, RGB+HV cables to DB15HD connector for HDTV, video projector applications. True 75 ohm connectors and cable for accurate video and sync transfers. Length 1'. Use with Calrad 55-611, 55-612 molded cables or other RGB+HV cables.



55-620 DB15HD FEMALE TO 5 BNC FEMALE RGB/HV CABLE

Premium signal breakout cable. Allows direct conversion of a 5 BNC, RGB+HV cable to DB15HD connector for HDTV, video projector applications. True 75 ohm connectors and cable for accurate video and sync signal transfers. Overall cable O.D. .37".

55-620-1.....	1 ft.
55-620-3.....	3 ft.
55-620-6.....	6 ft.

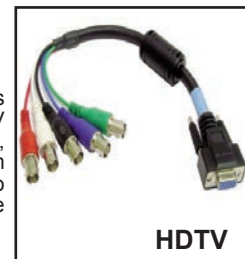

55-621 SHIELDED DB15HD MALE TO 5 BNC FEMALE RGB/HV CABLE

Premium signal breakout cable. Allows direct conversion of a 5 BNC, RGB+HV cable to DB15HD connector for HDTV, video projector applications. True 75 ohm connectors and cable for accurate video and sync signal transfers. Overall cable O.D. .37".

55-621.....	6 Inches	55-621-6.....	6 ft.
55-621-1.....	1 ft.	55-621-10.....	10 ft.
55-621-3.....	3 ft.	55-621-12.....	12 ft.



CALRAD

55 Series - SVGA Cables

SVGA CABLES

55-612 Male to Male

Shielded high quality SVGA HD-DB15 interface cables with ferrite RFI/EMI filters at each end. Perfect for computer displays. Connectors come with long plastic thumb screws and protective dust caps. Overall cable O.D. .37". Specify length when ordering.

Lengths Available

Male to Male

55-612-6"	6 n
55-612-3	3 ft
55-612-6	6 ft
55-612-10	10 ft
55-612-12	12 ft
55-612-15	15 ft
55-612-25	25 ft
55-612-30	30 ft
55-612-35	35 ft
55-612-50	50 ft
55-612-75	75 ft
55-612-100	100 ft
55-612-250	Bulk Spool

55-614 Male to Female

Male to Female

55-614-3	3 ft.
55-614-6	6 ft.
55-614-10	10 ft.
55-614-12	12 ft.
55-614-25	25 ft.
55-614-35	35 ft.
55-614-50	50 ft.
55-614-75	75 ft.
55-614-100	100 ft.

HDTV



Supports PC Plug and Play

WHITE SVGA CABLES

Shielded high quality SVGA HD-DB15 interface cables with ferrite RFI/EMI filters at each end. Perfect for computer displays. Connectors come with long plastic thumb screws and protective dust caps. Overall cable O.D. .37". Specify length when ordering.

Lengths Available

Male to Male

55-612-3-WH	3 ft.
55-612-6-WH	6 ft.
55-612-10-WH	10 ft.
55-612-12-WH	12 ft.
55-612-15-WH	15 ft.
55-612-25-WH	25 ft.

HDTV



55-612-white series

Supports PC Plug and Play

HDTV HIGH QUALITY SVGA CABLES

55-612-HDTV Male to Male

55-614-HDTV Male to Female

High quality HDTV digital HD-DB15 interface cables with overall shield and 5 miniature shielded 75 ohm coax cables with tin plating and ferrite RFI/EMI filters at each end. Connectors come with long plastic thumb screws and protective dust cap. This cable is manufactured to maintain accurate video and timing signals. Used for HDTV applications. Overall cable O.D. .44".

Specify length when ordering.

Lengths Available

Male to Male

55-612-HDTV-3	3 ft.
55-612-HDTV-6	6 ft.
55-612-HDTV-10	10 ft.
55-612-HDTV-12	12 ft.
55-612-HDTV-25	25 ft.
55-612-HDTV-35	35 ft.
55-612-HDTV-50	50 ft.
55-612-HDTV-75	75 ft.
55-612-HDTV-100	100 ft.

Male to Female

55-614-HDTV-3	3 ft.
55-614-HDTV-6	6 ft.
55-614-HDTV-10	10 ft.
55-614-HDTV-12	12 ft.
55-614-HDTV-25	25 ft.
55-614-HDTV-35	35 ft.
55-614-HDTV-50	50 ft.
55-614-HDTV-75	75 ft.
55-614-HDTV-100	100 ft.

HDTV



Does Not Support PC Plug and Play

SVGA CABLES WITH ALL METAL CONNECTORS

55-612-S Male to Male

55-614-S Male to Female

Custom made with metal housings, high quality HDTV digital HD-DB15 interface cables with overall shield and 5 miniature shielded 75 ohm coax cables with tin plating. Gold plated connectors with metal thumb screws. This cable is manufactured to maintain accurate video and timing signals. Used for HDTV applications. Custom cables lengths available upon request. Overall cable O.D. .37". Specify length when ordering.

Lengths Available

Male to Male

55-612-S-3	3 ft.
55-612-S-6	6 ft.
55-612-S-10	10 ft.
55-612-S-12	12 ft.
55-612-S-25	25 ft.
55-612-S-35	35 ft.
55-612-S-50	50 ft.
55-612-S-75	75 ft.
55-612-S-100	100 ft.

Male to Female

55-614-S-3	3 ft.
55-614-S-6	6 ft.
55-614-S-10	10 ft.
55-614-S-12	12 ft.
55-614-S-25	25 ft.
55-614-S-35	35 ft.
55-614-S-50	50 ft.
55-614-S-75	75 ft.
55-614-S-100	100 ft.

HDTV



Does Not Support PC Plug and Play

CALRAD

55 Series - SVGA, DVI Cables

55-613M MOLDED SVGA AND 3.5mm STEREO AUDIO CABLE

High Quality SVGA cable with audio combined. Comes with gold plated HD15 and 3.5mm stereo male to provide combined audio and video in one cable.

Lengths Available

55-613M-3	3 ft.
55-613M-6	6 ft.
55-613M-10	10 ft.
55-613M-15	15 ft.
55-613M-25	25 ft.
55-613M-35	35 ft.
55-613M-50	50 ft.
55-613M-75	75 ft.
55-613M-100	100 ft.

Perfect for Laptop or DFP Use

SVGA and 3.5mm stereo audio cable with metal connectors

55-613-12	12 ft.
-----------	--------



55-613M

55-624-HDTV VGA to DVI-I Cable

Lengths Available

55-624-HDTV-3	3 ft.
55-624-HDTV-6	6 ft.
55-624-HDTV-12	12 ft.
55-624-HDTV-25	25 ft.
55-624-HDTV-35	35 ft.
55-624-HDTV-50	50 ft.



55-613-12

55-625 DVI MALE TO MALE DIGITAL VIDEO CABLES

Digital Video Interface (DVI) cables support high performance digital and analog signals. Used to interface PCs and high definition monitors, flat panel displays projectors TVs. Available in DVI-I and DVI-D.

DVI-I Digital and Analog

Lengths Available

55-625-3	3 ft.
55-625-6	6 ft.
55-625-10	10 ft.
55-625-12	12 ft.
55-625-15	15 ft.
55-625-20	20 ft.
55-625-25	25 ft.
55-625-35	35 ft.
55-625-50	50 ft.

HDTV VERSION DVI-I Digital or Analog

Lengths Available

55-625-HDTV-3	3 ft.
55-625-HDTV-6	6 ft.
55-625-HDTV-10	10 ft.
55-625-HDTV-12	12 ft.
55-625-HDTV-15	15 ft.
55-625-HDTV-25	25 ft.
55-625-HDTV-35	35 ft.
55-625-HDTV-50	50 ft.



DVI-D Digital Only

Lengths Available

55-625D-3	3 ft.
55-625D-6	6 ft.
55-625D-10	10 ft.
55-625D-12	12 ft.
55-625D-15	15 ft.
55-625D-20	20 ft.
55-625D-25	25 ft.
55-625D-35	35 ft.
55-625D-50	50 ft.

DVI-D Digital Only

Lengths Available

55-625D-HDTV-3	3 ft.
55-625D-HDTV-6	6 ft.
55-625D-HDTV-10	10 ft.
55-625D-HDTV-12	12 ft.
55-625D-HDTV-15	15 ft.
55-625D-HDTV-25	25 ft.
55-625D-HDTV-35	35 ft.
55-625D-HDTV-50	50 ft.

DVI-I PINOUT



DVI-D PINOUT
No Analog pins



55-625D-WH

DVI-D Digital Only White jacket

55-625D-3-WH	3 ft.
55-625D-6-WH	6 ft.
55-625D-10-WH	10 ft.
55-625D-12-WH	12 ft.
55-625D-25-WH	25 ft.

DVI ADAPTERS



Male DVI-I Female DVI-D Female VGA

35-601

DVI-I Male to DVI-I Female and VGA Female Adapter 12" Long



35-710

DVI-I Female to DVI-I Female Coupler

55 Series - HDMI High Speed Cables

55-643A HDMI High Speed Male to Male cable with Rotating Connectors

24K gold plated Male to Male HDMI cable with 90 degree vertical rotating connectors. 28 awg 10.2 Gbps.

Lengths Available

55-643A-HS-1.....	1 ft.
55-643A-HS-3.....	3 ft.
55-643A-HS-6.....	6 ft.
55-643A-HS-10.....	10 ft.
55-643A-HS-12.....	12 ft.
55-643A-HS-15.....	15 ft.



55-643B HDMI High Speed Male to Male cables with Rotating Connectors

24K gold plated Male to Male HDMI cable with 90 degree horizontal rotating connectors. 28 awg 10.2 Gbps.

Lengths Available

55-643B-HS-1.....	1 ft.
55-643B-HS-3.....	3 ft.
55-643B-HS-6.....	6 ft.
55-643B-HS-10.....	10 ft.
55-643B-HS-12.....	12 ft.
55-643B-HS-15.....	15 ft.



55-644A HDM High Speed Male to Female cable with Rotating Connectors

24K gold plated Male to Female HDMI cable with 90 degree vertical rotating connectors. 28 awg 10.2 Gbps.

Lengths available

55-644A-HS-6" ⁹	6 in
55-644A-HS-1.....	1 ft.
55-644A-HS-2.....	2 ft.
55-644A-HS-3.....	3 ft.
55-644A-HS-6.....	6 ft.
55-644A-HS-10.....	10 ft.
55-644A-HS-12.....	12 ft.
55-644A-HS-15.....	15 ft.



55-644B HDMI 1.3 Male to Female cable with Rotating Connectors

24K gold plated Male to Female HDMI cable with 90 degree horizontal rotating connectors. 28 awg 10.2 Gbps.

Lengths available

55-644B-HS-6" ⁹	6 in
55-644B-HS-1.....	1 ft.
55-644B-HS-3.....	3 ft.
55-644B-HS-6.....	6 ft.
55-644B-HS-10.....	10 ft.
55-644B-HS-12.....	12 ft.
55-644B-HS-15.....	15 ft.



HDMI Male to Male 1.3 SPEC 1080P Lengths Available

55-626-HS-50.....	50 ft.
55-626-HS-75.....	75 ft.
55-626-HS-100.....	100 ft.

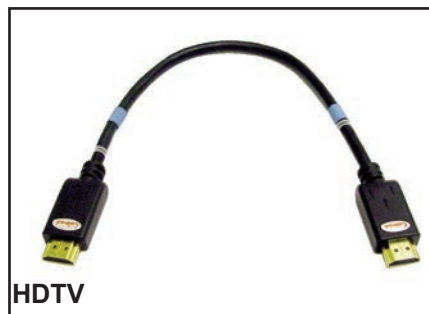

White HDMI 1.2 Male to Male Lengths Available

55-626-3-WH.....	3 ft.
55-626-6-WH.....	6 ft.
55-626-10-WH.....	10 ft.
55-626-12-WH.....	12 ft.
55-626-15-WH.....	15 ft.
55-626-25-WH.....	25 ft.



55-626A Inline HDMI Pigtail Amp Full High Def with no power supply
 HDMI 1.2 compliant. Can extend HDMI up to 150 at resolutions of 1080P or lower. Input signal 1.2 volts p-p. 6 inch pigtail. Works on HDMI supplied 5 volts.
55-626A-50...Amplified HDMI cable 50 ft.

CALRAD

55 Series - HDMI High Speed Cables

HDMI Male to Male

High Speed 1080P with snake skin
Lengths Available

55-636-HS-1.3-3	3 ft.
55-636-HS-1.3-6	6 ft.
55-636-HS-1.3-10	10 ft.



HDMI 1.4 Male to Male

Lengths Available

55-647-1.4-3	3 ft.
55-647-1.4-6	6 ft.
55-647-1.4-10	10 ft.
55-647-1.4-12	12 ft.
55-647-1.4-25	25 ft.
55-647-1.4-35	35 ft.



HDMI Male to Male

High Speed 1080P

Lengths Available

55-637-HS-1	1 ft.
55-637-HS-1.5	18 in.
55-637-HS-3	3 ft.
55-637-HS-6	6 ft.
55-637-HS-10	10 ft.
55-637-HS-12	12 ft.
55-637-HS-15	15 ft.
55-637-HS-20	20 ft.
55-637-HS-25	25 ft.
55-637-HS-30	30 ft.
55-637-HS-35	35 ft.

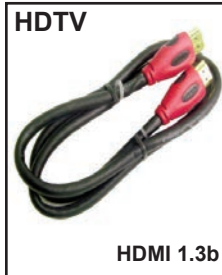

HDMI 1.4 Specifications

HDMI Ethernet Channel, Audio Return Channel, Supports High Resolution 3D TV Over HDMI. Supports 4K x 2K Resolution. Supports Expanded Color Space. Gold plated 19 pin HDMI Connector (Type A).

New Flat HDMI Series UL Approved HDMI Male to Male

1.3 SPEC 1080P interface cable construction reduces signal noise and digital jitter. The Oxygen-Free copper (OFC) minimizes signal loss and attenuation of signals. It's unique flat cable design provides added physical benefits of using the cable under carpeting and in areas that require a low overall profile.

55-627-1	1 ft.
55-627-2	2 ft.
55-627-3	3 ft.
55-627-6	6 ft.
55-627-10	10 ft.
55-627-12	12 ft.
55-627-15	15 ft.
55-627-20	20 ft.
55-627-25	25 ft.
55-627-30	30 ft.
55-627-35	35 ft.
55-627-50	50 ft.



HDMI 1.3, CL2 Male to Male

Lengths Available

55-639-1.3-3	3 ft.
55-639-1.3-6	6 ft.
55-639-1.3-10	10 ft.
55-639-1.3-12	12 ft.
55-639-1.3-25	25 ft.
55-639-1.3-35	35 ft.



DVI-D to HDMI Male to Male

Lengths Available

55-628-3	3 ft.
55-628-6	6 ft.
55-628-10	10 ft.
55-628-12	12 ft.
55-628-15	15 ft.
55-628-25	25 ft.
55-628-35	35 ft.
55-628-50	50 ft.



Lengths Available

55-648-1.4-1	1 ft.
55-648-1.4-3	3 ft.
55-648-1.4-6	6 ft.
55-648-1.4-10	10 ft.
55-648-1.4-15	15 ft.
55-648-1.4-20	20 ft.
55-648-1.4-25	25 ft.
55-648-1.4-30	30 ft.
55-648-1.4-35	35 ft.
55-648-1.4-40	40 ft.
55-648-1.4-45	45 ft.
55-648-1.4-50	50 ft.



HDMI 1.3 Male to HDMI C Male

Gold-plated Male 19-pin Mini-HDMI type C connector to Gold-plated Male 19-pin HDMI type A connector. HDMI 1.3b compliant.

Lengths Available

55-646-HD1.3-1	1 ft.
55-646-HD1.3-3	3 ft.
55-646-HD-1.3-6	6 ft.
55-646-HD-1.3-10	10 ft.
55-646-HD-1.3-12	12 ft.
55-646-HD-1.3-15	15 ft.



CALRAD

55 Series - Component Video Cables

55-615 HIGH QUALITY COMPONENT VIDEO CABLE

Silver plated, flat, triple shielded 75 Ohm RGB component video cable with Teflon dielectric. Gold Plated RCA turbine series connectors with compression strain relief.

55-615-3.....	3 ft.
55-615-6.....	6 ft.
55-615-10.....	10 ft.
55-615-12.....	12 ft.
55-615-15.....	15 ft.
55-615-20.....	20 ft.
55-615-25.....	25 ft.
55-615-330.....	330 ft. spool, bulk cable.

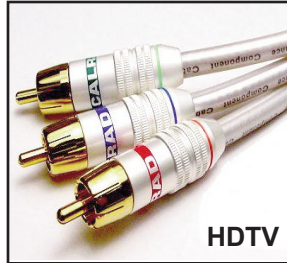

HDTV

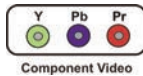

Component Video

55-871A SERIES COMPONENT VIDEO CABLE SHIELDED

Same specs as 55-871 but with smaller strain relief

55-871A-3.....	3 ft.
55-871A-6.....	6 ft.
55-871A-10.....	10 ft.
55-871A-12.....	12 ft.
55-871A-25.....	25 ft.
55-871A-35.....	35 ft.
55-871A-50.....	50 ft.



55-871 MOLDED COMPONENT VIDEO CABLE SHIELDED

75 ohm shielded cable with 3 molded RCA gold plated Male ends. Overall cable O.D. .485". Black PVC jacket. Red, green, blue mini coax cables .16" O.D. Heavy Duty Strain Relief.

55-871-3.....	3 ft.
55-871-6.....	6 ft.
55-871-10.....	10 ft.
55-871-12.....	12 ft.
55-871-15.....	15 ft.
55-871-20.....	20 ft.
55-871-25.....	25 ft.
55-871-30.....	30 ft.
55-871-35.....	35 ft.
55-871-50.....	50 ft.
55-871-55.....	55 ft.
55-871-100.....	100 ft.



HDTV

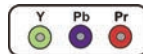

Component Video

55-871F MOLDED COMPONENT VIDEO CABLE SHIELDED

75 ohm shielded cable with 3 molded RCA gold plated Males to 3 molded "F" gold plated Males. Overall cable O.D. .485". Black PVC jacket. Red, green, blue mini coax cables .16" O.D.

55-871F-6.....	6 ft.
55-871F-12.....	12 ft.
55-871F-25.....	25 ft.



HDTV

55-506 HIGH QUALITY COMPONENT VIDEO AND 2.2mm TOSLINK FIBER-OPTIC CABLE

Fiber-optic cable with shielded low loss RGB component cable. Terminated by gold metal connectors.

Overall cable O.D. .61" x .16".

Lengths are in Meters

55-506-2.....	2 Meters
55-506-3.....	3 Meters
55-506-4.....	4 Meters
55-506-5.....	5 Meters



HDTV

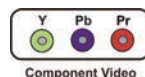

Component Video

+ Digital Audio

55-872 SHEILED COMPONENT VIDEO CABLE

75 ohm shielded cable with high quality gold plated connectors with chrome bodies and colored rubber finger grips. Overall cable O.D. .485". Black PVC jacket. Red, Green, Blue mini coax cables .16" O.D.

55-872-3.....	3 ft.
55-872-6.....	6 ft.
55-872-12.....	12 ft.
55-872-15.....	15 ft.
55-872-20.....	20 ft.
55-872-25.....	25 ft.
55-872-35.....	35 ft.
55-872-50.....	50 ft.
55-872-250.....	250 ft. spool, bulk cable

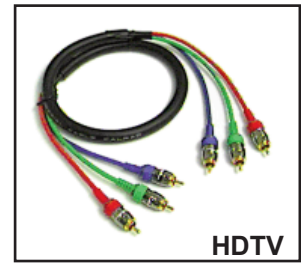

HDTV

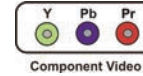

Component Video

55-871A -WHITE SERIES COMPONENT CABLES

with premium RCA Plugs

55-871A-3-WH.....	3 ft.
55-871A-6-WH.....	6 ft.
55-871A-10-WH.....	10 ft.
55-871A-12-WH.....	12 ft.
55-871A-25-WH.....	25 ft.
55-871A-35-WH.....	35 ft.
55-871A-50-WH.....	50 ft.
55-871A-250-WH.....	250 ft. spool, bulk cable



55-870 COMPONENT CABLES WITH SPDIF AUDIO

55-870-3.....	3 ft.
55-870-6.....	6 ft.
55-870-10.....	10 ft.
55-870-12.....	12 ft.
55-870-25.....	25 ft.
55-870-35.....	35 ft.
55-870-50.....	50 ft.

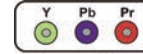

Component Video

55-870-WH COMPONENT CABLES WITH SPDIF AUDIO

55-870-3-WH.....	3ft.
55-870-6-WH.....	6ft.
55-870-10-WH.....	10ft.
55-870-12-WH.....	12ft.
55-870-25-WH.....	25ft.
55-870-35-WH.....	35ft.
55-870-50-WH.....	50ft.
55-870-250-WH.....	250ft. spool, bulk cable



55-505 MOLDED COMPONENT VIDEO AND 2.2mm TOSLINK FIBER-OPTIC CABLE

Applications include connecting DVD players and satellite receivers to A/V receivers. Fiber-optic cable with shielded low loss RGB component cable. Terminated by molded gold connectors. Overall cable O.D. .61" x .16".

55-505-2.....	2 Meters
55-505-3.....	3 Meters
55-505-4.....	4 Meters
55-505-5.....	5 Meters



HDTV

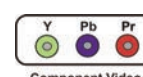

Component Video

CALRAD

55 Series - Component, Audio-Video Cables

5 RCA MOLDED MALES TO 5 RCA MOLDED MALES, SHIELDED, GOLD PLATED CONNECTORS

55-611-RCA-3	3 ft.
55-611-RCA-6	6 ft.
55-611-RCA-10	10 ft.
55-611-RCA-12	12 ft.
55-611-RCA-15	15 ft.
55-611-RCA-20	20 ft.
55-611-RCA-25	25 ft.
55-611-RCA-35	35 ft.
55-611-RCA-50	50 ft.
55-611-RCA-100	100 ft.



55-510 SHIELDED RGB + SYNC HDTV CABLE

This cable is used for HDTV applications. Terminated with 5 high quality gold plated RCA connectors with chrome bodies and color coded rubber finger grips, specifically designed to minimize signal loss. For RGB+HV or RGB + Audio (Y,Pb,Pr + Audio), signal delivery. Silver plated cable for accurate signal transfer. Overall cable O.D. .37". Individual cable O.D. .1".

55-510-6	6 ft.
55-510-10	10 ft.
55-510-12	12 ft.

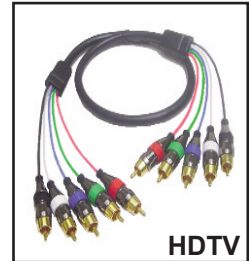

SHIELDED RGB VIDEO CABLES

(3) BNC Males to (3) BNC Males Comes with 75 ohm nickel plated connectors. Cable O.D. .525",

55-610-3	3 ft.
55-610-6	6 ft.
55-610-10	10 ft.
55-610-12	12 ft.
55-610-15	15 ft.
55-610-25	25 ft.
55-610-33	33 ft.
55-610-35	35 ft.
55-610-50	50 ft.
55-610-100	100 ft.
55-610-500	500 ft.



55-618 LOW LOSS MULTI-CONDUCTOR (RGB+HV, STEREO AUDIO) SHIELDED COAX AUDIO/VIDEO CABLE. SUPPORTS STANDARD DEFINITION AND HDTV.

7 Individually molded, color coded cables. 5 x True 75 Ohm BNC's (RGB + HV) video Male plugs. 2 x RCA stereo analog audio Male plugs (1 ea. Black barrels with Red & White bands). Overall cable O.D. .44", Individual cable O.D. .12", individual cable lengths from strain relief 8". Available in 6,12 & 25ft. lengths.



SHIELDED RGB VIDEO CABLES

(5) BNC Males to (5) BNC Males Comes with 75 ohm nickel plated connectors. Cable O.D. (.65").

55-611-3	3 ft.
55-611-6	6 ft.
55-611-10	10 ft.
55-611-12	12 ft.
55-611-15	15 ft.
55-611-20	20 ft.
55-611-25	25 ft.
55-611-50	50 ft.
55-611-100	100 ft.
55-611-250	250 ft.
55-611-500	500 ft.



55-509 5.1 SHIELDED DIGITAL AUDIO CABLE for SACD, DVD-AUDIO, and SURROUND SOUND SYSTEMS

Interface cable between DTS, digital sound processors, digital processor based DVD players to amplifiers/receivers. Easy to read ID channel labels. 6 RCA plugs both ends. Overall cable O.D. (.435"). Individual cable O.D. (.103").

55-509-6	6 ft.
55-509-12	12 ft.



55-616 LOW LOSS MULTI-CONDUCTOR (COMPONENT VIDEO, COMPOSITE, SVHS, STEREO ANALOG, DIGITAL AUDIO) SHIELDED COAX AUDIO/VIDEO CABLE. SUPPORTS STANDARD DEFINITION AND HDTV.

9 Individually molded, color coded cables, grouped & labeled. 1 x RCA composite video Male plug (Yellow), 1 x SVHS molded Male plug, 3 x RCA component video plugs (Y=Green, Pb=Blue, Pr= Red), 4 x each RCA stereo analog audio Male plugs (2 ea. Red & White, 2 stereo audio channels), 1 x RCA Digital audio Male plug (Orange). This cable can be used for stand alone audio & video signal delivery or for Calrad's 40-934B 1 x 5 HDTV distribution amplifiers. Overall cable O.D. 1.0", Individual cable O.D. (.2"), individual cable lengths from strain relief 11".

Lengths Available

55-616-6	6 ft.	55-616-12	12 ft.	55-616-25	25 ft.
----------	-------	-----------	--------	-----------	--------



55 Series - Component, S-Video Cables

55-617 LOW LOSS MULTI-CONDUCTOR (COMPONENT VIDEO, COMPOSITE VIDEO, STEREO ANALOG AUDIO, RF) SHIELDED COAX AUDIO/VIDEO CABLE. SUPPORTS STANDARD DEFINITION AND HDTV.

7 Individually molded, color coded cables. 1 x RCA composite video Male plug (Yellow). 3 x RCA component video Male plugs (Y=Green, Pb=Blue, Pr= Red). 2 x RCA stereo analog audio Male plugs (1 ea. Red & White), 1 x RCA Digital audio Male plug (Orange). 1 x "F" RF Male plug (Black). Overall cable O.D. .47", Individual cable O.D. .12", individual cable lengths from strain relief 8".

Lengths Available

55-617-5.....5 ft.	55-617-9.....9 ft.
55-617-7.....7 ft.	55-617-12.....12 ft.



55-771G High Quality Low Loss SVHS Cable With Gold SVHS 4 pin Connectors

8mm shielded high quality SVHS cable terminated with Calrad 30-608 4-pin SVHS gold plated connectors. Miniature shielded 75 ohm video coax cable, 1-RED, 1-YELLOW. Cable O.D. 8mm/.315". Multi-strand tension baring filler for superb strength. Flexible .042" thick rubber jacket. Individual coax cable diameter .122". Individual foamed PE cable dielectric insulation, O.D. .087". Center conductor 24 awg. Nominal capacitance 16.9pf/ft. Shielding 95% braided copper. Dark gray PVC jacket. Custom lengths also available, please ask your Calrad sales representative for your specific needs.

55-771G-3.....3 ft.
55-771G-6.....6 ft.
55-771G-12.....12 ft.
55-771G-25.....25 ft.
55-771G-330.....Bulk Cable 330 ft.

Custom Lengths Available

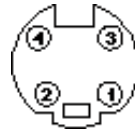

SVHS 4 Pin Mini Din Pinout



55-770GR Round Jacketed SVHS Cable.

Black jacketed, double shielded, non-molded, black anodized Male to Male molded SVHS video cable. 65% 'OFC' braided copper over 100% foil shield, 7mm O.D.

55-770GR-3.....3 ft.
55-770GR-6.....6 ft.
55-770GR-10.....10 ft.
55-770GR-12.....12 ft.
55-770GR-15.....15 ft.
55-770GR-25.....25 ft.
55-770GR-50.....50 ft.
55-770GR-100.....100 ft.
55-770GR-500.....Bulk Cable 500 ft.



55-770G

Super-VHS Flat Cables. 4-Pin to 4-Pin Plug – Gold

Flexible S-VHS Cable. Low loss pro style cable for running long lengths. 75 ohm dual flat coax cable. 27 awg wire, spiral copper shielded with black PVC black jacket. molded connectors with gold plated contacts. Capacitance is 55pf/m (16.8pf/ft). Attenuation is approx. .06db/m at 10mHz. Shielded.

55-770G-1.....1 ft. flat cable
55-770G-3.....3 ft. flat cable
55-770G-6.....6 ft. flat cable
55-770G-10.....10 ft. flat cable
55-770G-12.....12 ft. flat cable
55-770G-15.....15 ft. flat cable
55-770G-20.....20 ft. flat cable
55-770G-25.....25 ft. flat cable
55-770G-30.....30 ft. flat cable
55-770G-50.....50ft. flat cable
55-770G-75.....75 ft. flat cable
55-770G-100.....100 ft. flat cable
55-770G-1000 1000 ft., spool flat cable . w/ no ends.



55-772G High Quality, Low Loss SVHS Cable with Gold SVHS Connectors, Silver Colored

Silver jacketed, triple shielded, High Quality non-molded SVHS video cable Male to Male. Dual miniature spiral shielded coax cables with 65% 'OFC' braided copper over 100% foil shield coverage, 8mm O.D.

55-772G-3.....3 ft.
55-772G-6.....6 ft.
55-772G-10.....10 ft.
55-772G-12.....12 ft.
55-772G-15.....15 ft.
55-772G-20.....20 ft.
55-772G-25.....25 ft.
55-772G-50.....50 ft.
55-772G-75.....75 ft.
55-772G-100.....100 ft.
55-772G-250.....Bulk Cable 250 ft.

Metal Connectors with Gold Contacts & Silver Finish



55-740G

Gold Plated SVHS 4-Pin Plug To Blunt Cut End

6 foot flat, shielded flexible S-VHS cable. Low loss pros style cable for running long lengths. 75 ohm dual flat coax cable. 27 awg wire, spiral copper shielded with black PVC jacket. Capacitance is 55pf/m (16.6pf/ft). Attenuation is approx. .06db/m at 10mhz. Gold plated SVHS connector



Plenum SVHS Cables Available Upon Request. Call Calrad for Details

CALRAD

55 Series - S-VIDEO, Video Cables

55-773G

SVHS 4-Pin Plug to 4-Pin Jack— Gold Connectors

Flexible S-VHS cable. Low loss pro style cable for running long lengths. Gold plated connectors 75 Ohm dual flat coax cable. 27 awg wire, spiral copper shielded with black PVC jacket. Capacitance is 55pf/m (16.8pf/ft). Attenuation is approx. .06db/m at 100mhz. Shielded.

- 55-773G-6 6 ft., flat cable
- 55-773G-10 10 ft., flat cable
- 55-773G-25 25 ft., flat cable



55-774G

Right Angle SVHS Cable with Varied Pin Configurations 6 ft.

Right angle gold SVHS cables with 4 pin Male gold plated SVHS connectors. Individually shielded 75 ohm coax cables for luminance and chrominance signals. Cable allows for low profile hookups. Reversing the cable provides more connecting options. Overall cable O.D. .23" x .12". 27 awg wire, spiral copper shielded with black PVC jacket. Capacitance is 55pf/m (16.8pf/ft). Attenuation is approx. .06db/m at 100mhz.

- 55-774G-A..... Type 1 to 1
- 55-774G-B..... Type 2 to 2
- 55-774G-C..... Type 1 to 2



55-508 6mm MOLDED SVHS AND 5mm TOSLINK FIBER-OPTIC CABLE

Molded interconnect cable applications include connecting DVD players and satellite receivers to A/V receivers. Shielded low loss S-video cable terminated by metal gold connectors. Overall cable O.D. .465" x .24". Black PVC jacket.

Lengths are in Meters

- 55-508-2.....2 Meters
- 55-508-3.....3 Meters
- 55-508-4.....4 Meters
- 55-508-5.....5 Meters



55-507 MOLDED SVHS AND 5mm TOSLINK FIBER-OPTIC CABLE

Molded interconnect cable applications include connecting DVD players and satellite receivers to A/V receivers. Shielded low loss S-video cable terminated by molded connectors with gold contacts.

- 55-507-2.....2 Meters
- 55-507-3.....3 Meters
- 55-507-4.....4 Meters
- 55-507-5.....5 Meters



55-868B SHIELDED SVHS A/V INTERFACE/ DUBBING CABLE

A/V Dubbing Cable with SVHS and Dual RCA Molded Plugs Cable O.D. .51" x .20".

- 55-868B-33 ft.
- 55-868B-66 ft.
- 55-868B-1212 ft.



SVHS MALE TO 2 RCA MALE

- 55-741G.....6 Inches
- 55-741G-1.5.....18 Inches
- 55-741G-6.....6 ft.

SVHS MALE TO 2 RCA FEMALE SEPARATOR CABLE

- 55-739 (New)....6 Inches

One (1) SVHS 4-pin plug to either 2 RCA plugs (55-741G) or jacks (55-739). Nickel plated connectors with shielded, flat cable. Overall cable O.D. .24" x .12". Black PVC jacket.

White RCA = luminance,
Red RCA = chrominance



55-742

SVHS MALE TO 2 BNC FEMALE SEPARATOR CABLE

One SVHS 4-pin plug to dual (2) BNC in-line jacks, molded, nickel plated contacts. flat cable. Shielded. Overall cable O.D. .24" x .12". Black PVC jacket.

White BNC = luminance,
Red BNC = chrominance.

Lengths Available:

- 55-742.....6 inch.
- 55-742-1.5.....18 inch.
- 55-742-3.....3 ft.
- 55-742-6.....6 ft.

55-742F-P SVHS Female to 2 BNC Female panel mount separator cable.



55-743

SVHS MALE TO DUAL BNC MALE SEPARATOR CABLE

One (1) SVHS 4-pin plug (Gold Plated) to two (2) BNC plugs. Nickel plated connectors, shielded flat cable. Overall cable O.D. .24" x .12". Black PVC jacket.

White BNC = luminance,
Red BNC = chrominance

Lengths Available

- 55-743.....6 inches
- 55-743-1.....1 ft.
- 55-743-3.....3 ft.
- 55-743-6.....6 ft.
- 55-743-10.....10 ft.



55-744

SVHS MALE TO 2 F-81s SEPARATOR CABLE

Separates SVHS cable signal to 2 F-81 connectors for easy connection using F-F cable to carry chrominance and luminance signals. Uses 75 ohm shielded miniature coax cable. Black PVC jacket. Overall cable O.D. .19" x .1". Individual coax O.D. .19". Black PVC jacket. Single nickel plated SVHS Male to dual F-81 Females.

Red F-81=luminance,
Black F-81=chrominance.

- Lengths Available 55-744.....18 inches
- 55-744-5.....5 ft.



Uses 2 RG6 cables to carry SVHS signals.

55 Series - Toslink Cables, Digital Converter

55-502 5mm FIBER OPTIC CABLE

Toslink-Toslink Fiber-Optic Cable for Digital Audio with High Quality Toslink Connectors

Lengths are in Meters

55-502-1.....	1 meter
55-502-2.....	2 meters
55-502-3.....	3 meters
55-502-4.....	4 meters
55-502-5.....	5 meters
55-502-50.....	50 feet.

50 ft cable must be used with the Calrad 10-117 toslink amplifier.



55-504 5mm Spring Loaded

Toslink Fiber-Optic Cable.

Male to Male high performance 5mm fiber-optic cables offer the best protection against kinks and breakage caused by moving equipment. The cable exhibits tuned spectral attenuation for optimum signal admittance. The ends have a black nickel finish with gold plated precision polished tips for minimal reflectivity. Cable color is Grey

Lengths are in Meters

55-504-1.....	1 meter
55-504-2.....	2 meters
55-504-3.....	3 meters
55-504-4.....	4 meters
55-504-5.....	5 meters



55-500 2.2mm FIBER-OPTIC CABLE

Toslink-Toslink for Digital Audio

Lengths are in Meters

55-500-1.....	1 meter
55-500-2.....	2 meters
55-500-3.....	3 meters
55-500-4.....	4 meters
55-500-5.....	5 meters



55-520

2.2mm NEON COLORED FIBER-OPTIC AUDIO CABLES

2.2mm toslink to toslink, neon colored, fiber-optic cable available in green, purple, red and yellow colors.



Lengths are in Meters

Neon Green

55-520-GN-2.....	2 meters
55-520-GN-3.....	3 meters
55-520-GN-4.....	4 meters
55-520-GN-5.....	5 meters

Neon Red

55-520-RD-2.....	2 meters
55-520-RD-3.....	3 meters
55-520-RD-4.....	4 meters
55-520-RD-5.....	5 meters

Neon Purple

55-520-PR-3.....	3 meters
55-520-PR-4.....	4 meters

Neon Yellow

55-520-YL-2.....	2 meters
55-520-YL-3.....	3 meters
55-520-YL-4.....	4 meters
55-520-YL-5.....	5 meters

55-501 4mm FIBER-OPTIC CABLE

Toslink-Toslink for Digital Audio

Lengths are in Meters

55-501-1.....	1 meter
55-501-2.....	2 meters
55-501-3.....	3 meters
55-501-4.....	4 meters
55-501-5.....	5 meters



55-503-S 3.5mm to TOSLINK 2.2mm FIBER-OPTIC AUDIO CABLE

Lengths are in Meters

55-503-S-1.....	1 meter
55-503-S-2.....	2 meters
55-503-S-3.....	3 meters
55-503-S-4.....	4 meters
55-503-S-5.....	5 meters



55-503 5mm 3.5 TO TOSLINK FIBER-OPTIC AUDIO CABLE

Toslink to 3.5mm for Digital Audio

Lengths are in Meters

55-503-1.....	1 meter
55-503-2.....	2 meters
55-503-3.....	3 meters
55-503-4.....	4 meters
55-503-5.....	5 meters

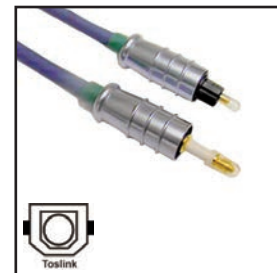

40-DCT-2 2 WAY DIGITAL AUDIO CONVERTER , REPEATER

Coaxial / Toslink audio converter, its compact size and convenient features provides simple solutions for interfacing digital audio gear. It accepts S/PDIF audio signal input through either Coaxial cable or Toslink cable, and passes the signal (as is) to both its coaxial and Toslink output ports. With its built-in amplification feature the 40-DCT-2 can also serve as a signal repeater and extend (double) the transferring distance. The 40-DCT-2 Cross-converts digital audio signals between "Toslink" optical and coax-electrical SPDIF formats transparently converting in either direction, and handling PCM (stereo) and bitstream (Dolby Digital, DTS) signals. Supports two-way conversion: coaxial to toslink or toslink to coaxial.



For other digital audio converters see page 71

CALRAD

55 Series - Home Theater Audio\Video Cables

Technical drawings and specifications are available for these cables. Please ask your Calrad sales representative for details.

HIGH RESOLUTION INTERCONNECT CABLES

Designed with the latest technology available today. 99.99% pure oxygen free copper "OFC" cable. Polystyrene foam insulation, double braided shield to protect against radio frequency interference. Heavy duty zinc alloy plated RCA connectors, 24 karat gold plating.



Locking RCA Connectors

55-715 Series

55-715 High Resolution 8mm Double Shielded Audio/Video Cable with Single Male to Male Gold Locking RCA Plugs.

High Quality audio or video cable with thick rubber jacket. 100% foil shield with 95% braided 'OFC' oxygen free copper shielding and center conductor. Cable O.D. 8mm, .315".

55-715-3.....	3 ft.
55-715-6.....	6 ft.
55-715-10.....	10 ft.
55-715-12.....	12 ft.
55-715-15.....	15 ft.
55-715-20.....	20 ft.
55-715-25.....	25 ft.
55-715-30.....	30 ft.
55-715-50.....	50 ft.
55-715-250.....	250 ft.
55-715-500 (Spool, Blue).....	500 ft.
55-715-BK-500 (Spool, Black).....	500 ft.

Weight is 25 lbs. per spool for 500 ft spool

SILVER SERIES



55-716 SPDIF HIGH QUALITY DIGITAL COAX AUDIO/VIDEO CABLES WITH 8mm SILVER CONDUCTOR WITH LOCKING SINGLE MALE TO MALE RCA PLUGS

Low capacitance, precision 110 ohm construction for sharp and accurate digital signal transfer. Specially designed for excellent performance over long runs. Tightly wound braided shielding resists leakage and outside interference. Cable O.D. .315".

55-716-3.....	3 ft.
55-716-6.....	6 ft.
55-716-10.....	10 ft.
55-716-12.....	12 ft.
55-716-25.....	25 ft.
55-716-250.....	Bulk Cable 250 ft.

Weight is 16 lbs. per spool.

CUSTOM LENGTHS AVAILABLE



55-710 Single Male to Male, Molded, Gold Plated RCA Plugs Using High Resolution Cable

55-710-3.....	3 ft.
55-710-6.....	6 ft.
55-710-10.....	10 ft.
55-710-12.....	12 ft.
55-710-15.....	15 ft.
55-710-20.....	20 ft.
55-710-25.....	25 ft.



55-717 DIGITAL AUDIO CABLE

6mm RCA Male to RCA Male molded plugs, gold plated contacts with foil and braided shielding. Orange colored molded ends.

55-717-3.....	3 ft.
55-717-6.....	6 ft.
55-717-12.....	12 ft.
55-717-15.....	15 ft.
*55-717-16.....	16 ft.
55-717-25.....	25 ft.

*While quantities last



55-717A DIGITAL AUDIO CABLE Super quality RCA Male to RCA Male cable.

UL rated. Made with a superior High quality RCA Plug with superior strain relief. Better cable and plug meet UL Standards. Orange\Black ends.

55-717A-3.....	3 ft.
55-717A-6.....	6 ft.
55-717A-12.....	12 ft.
55-717A-15.....	15 ft.
55-717A-25.....	25 ft.

CALRAD

55 Series - Audio Cables

GOLD PLATED AUDIO CABLE SERIES

18 Kt. Gold Plated RCA-type phono connectors insure against faulty connections. Ultra Low Loss shielded cable provides the best in audio reproduction. Gold plated Steel Springs provide strain relief and prevent damage to the cable from repeated flexing.

DUAL RCA MALE PLUGS

Dual RCA plugs at each end.
Separate ground. Gold Plated.
With ground wire.

55-800G	3 ft.
55-802G	6 ft.
55-803G	10 ft.



RCA MALE PLUG TO FEMALE JACK

RCA Male plug to RCA Female jack. Gold Plated.

55-812G	3 ft.
55-814G	6 ft.
55-815G	10 ft.



SHIELDED RCA MALE TO MALE JUMPER

RCA Male plugs at each end.
Gold Plated.

55-806G	3 ft.
55-808G	6 ft.
55-809G	10 ft.



4 RCA PLUGS

4 RCA Male plugs at both ends.
Color-coded. Gold Plated.

55-818G	3 ft.
55-820G	6 ft.
55-821G	10 ft.

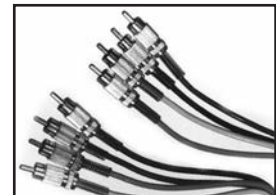

SHIELDED AUDIO CABLES

Male RCA molded plugs at each end.

55-930	1 1/2 ft.
55-931	3 ft.
55-932	4 ft.
55-933	5 ft.
55-934	6 ft.
55-935	10 ft.
55-915	15 ft.
55-916	25 ft.
55-916-50	50 ft.
55-916-100	100 ft.



55-860

4 RCA MALE TO MALE SHIELDED INTERFACE CABLE

4 RCA Male plugs on each end,
15 ft. long, color-coded. Shielded cable.



MULTI-COLORED SHIELDED PATCH CABLE KITS – GOLD-PLATED

Molded RCA Male plugs each end. One each of eight different colors per pkg.: red, orange, yellow, green, blue, black, gray & white.

55-750G	6 in. long
55-751G	1 ft. long
55-753G	2 ft. long
55-754G	3 ft. long
55-755G	6 ft. long

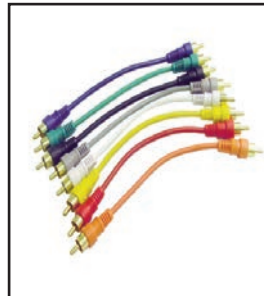

EXTENSION CABLES

Male RCA plug to Female RCA jack. Shielded cable.

55-980	3 ft.
55-981	4 ft.
55-982	5 ft.
55-983	6 ft.
55-984	10 ft.
55-918	15 ft.
55-919	25 ft.



55-910 AUDIO JUMPER CABLE KIT

Audio cable kit. Consists of four 36-inch shielded cables with RCA Male plugs on each end. Contains 1 each of the following colors: Gray, Green, Black and Red. 3 ft. long.



SHIELDED AUDIO CABLES

RCA Male plug with single jacket,
1 conductor shielded cable to stripped and tinned leads.

55-925	20 in
55-926	3 ft.
55-927	6 ft.
55-927-RT	6 ft. right angle plug
55-928	10 ft.



CALRAD

55 Series - Audio Cables



55-705 High Resolution 6mm Dual Audio Cable, Triple Shielded with High Quality Gold RCA Male to Male Metal Plugs

This cable is perfect for any stereo audio feed for home theater systems. 2 braided shields and 100% foil coverage. Cable O.D. .47" x .23".

- 55-705-1.....1ft.
- 55-705-3.....3 ft.
- 55-705-6.....6 ft.
- 55-705-10.....10 ft.
- 55-705-12.....12 ft.
- 55-705-15.....15 ft.
- 55-705-20.....20 ft.
- 55-705-25.....25 ft.
- 55-705-30.....30 ft.
- 55-705-50.....50 ft.
- 55-705-250..(Spool, Blue).....250 ft.
- 55-705-BK-250(Spool, Black).....250 ft.
- 55-705-330..(Spool).....330 ft.
- 55-705-500..(Spool).....500 ft.
- 55-705-BK-500(Spool,Black).....500 ft.



55-700 High Resolution 6mm Dual Audio Cable, Triple Shielded with Gold RCA Male to Male Plugs

- 55-700-3.....3 ft.
- 55-700-6.....6 ft.
- 55-700-10.....10 ft.
- 55-700-12.....12 ft.
- 55-700-15.....15 ft.
- 55-700-20.....20 ft.
- 55-700-25.....25 ft.



55-700-White High Resolution 6mm Audio Cable, Triple Shielded with Dual Molded Gold RCA Male to Male Plugs

- 55-700-3-WH.....3 ft.
- 55-700-6-WH.....6 ft.
- 55-700-10-WH.....10 ft.
- 55-700-12-WH.....12 ft.
- 55-700-15-WH.....15 ft.
- 55-700-20-WH.....20 ft.
- 55-700-25-WH.....25 ft.
- 55-700-250-WH.(Spool,White).250 ft.



SPEAKER JUMPER CABLES
Polarized with RCA Male plug to stripped and tinned leads.
2 per pkg.

- 55-962 6 ft.
- 55-966 20 ft.



55-985 MOLDED RCA EXTENSION (UNSHIELDED) CABLE

Molded RCA Male plug to molded RCA Female jack. 25 ft. long.



55-865 SPEAKER JUMPER CABLE 10 FT.

Polarized with molded RCA Male plug on one end, other end is blunt cut. 1 per package.



55-967 SPEAKER JUMPER CABLE
Polarized speaker cables with RCA Male plugs on each end.
2 per pkg. 20 ft. long.



55-979 SPEAKER JUMPER CABLE
5 ft. Polarized jumper cable with molded RCA Male plugs each end. Color is Black.

CALRAD

55 Series - Audio\Video Cables

GOLD-PLATED DUAL RCA-RCA, SHIELDED STEREO AUDIO CABLES

Gold-Plated, dual RCA Male molded plugs at each end.

55-1010G	3 ft.
55-1011G	6 ft.
55-1013G	15 ft.
55-1015G	25 ft.



SHIELDED STEREO AUDIO CABLES

Dual right angle RCA Male molded plugs at each end.

55-1005	3 ft.
55-1007	6 ft.
55-1008	10 ft.



RCA DUAL STACKING SHIELDED PATCH CABLES

Gold-Plated, unique stacking design allows you to connect multiple components to one set of inputs.

55-1003G-3	3 ft.
55-1003G-6	6 ft.
55-1003G-10	10 ft.
55-1004G-15	15 ft.



DUAL RCA FEMALE CONNECTING CABLES

Two polarized RCA Females on each end. Shielded cable.

55-989	4 ft.
55-990	10 ft.



55-864B SHIELDED BNC A/V INTERFACE/ DUBBING CABLE

A/V Dubbing Cable with BNC and Dual RCA Gold Plated Plugs Both Ends.
Overall cable O.D. .57" x .20".

55-864B-3	3 ft.
55-864B-6	6 ft.
55-864B-12	12 ft.



55-862B SHIELDED STEREO AUDIO VIDEO INTERFACE DUBBING CABLES WITH MOLDED & GOLD PLATED PLUGS

Combines 75 ohm RCA-RCA video cable and (2) RCA to (2) RCA audio dubbing cable. Color coded; yellow is video, red and white are audio.
Overall cable O.D. .49" x .24".

55-862B-1.5	1.5 ft.
55-862B-3	3 ft.
55-862B-6	6 ft.
55-862B-12	12 ft.
55-862B-15	15 ft.
55-862B-20	20 ft.
55-862B-25	25 ft.
55-862B-50	50 ft.
55-862B-75	75 ft.
55-862B-250	250 ft. bulk cable



DUAL RCA-RCA, SHIELDED STEREO AUDIO CABLES

Dual RCA Male molded plugs at each end. Flat zip style cable

55-924	1 ft.
55-923	3 ft.
55-998	4 ft.
55-999	6 ft.
55-1000B-9	9 ft.
55-1000	10 ft.
55-1000B-12	12 ft.
55-1000B-15	15 ft.
55-1001	20 ft.
55-1002	25 ft.
55-1000B-35	35 ft.
55-1000B-50	50 ft.
55-1000B-75	75 ft.
55-1000B-100	100 ft.
55-1000B-1000	1000 ft.



55-1016G GOLD-PLATED DUAL RCA-RCA, SHIELDED STEREO AUDIO CABLES

Gold-Plated, dual RCA Male molded plugs at each end with trigger wire.

55-1016G-3	3 ft.
55-1016G-6	6 ft.
55-1016G-10	10 ft.
55-1016G-15	15 ft.
55-1016G-25	25 ft.



SHIELDED STEREO CABLES

Dual RCA Male plugs to dual RCA Female jacks.

55-988	4 ft.
55-988-6	6 ft.
55-991	10 ft.



55-862 PROFESSIONAL, SHIELDED HIGH-QUALITY VIDEO INTERFACE DUBBING CABLE

Combines 75 ohm RCA-RCA video cable and (2) RCA to (2) RCA plugs, audio dubbing cable. (Color-coded) Gold plated plugs.

55-862-3	3 ft.
55-862-6	6 ft.
55-862-12	12 ft.



55-863B VIDEO/MONO AUDIO DUBBING CABLE WITH MOLDED GOLD PLATED RCA MALE PLUGS

This cable features 75 ohm cord (both), and strain relief, for video dubbing between recorders. Color coded; yellow is video, red is audio.
Overall cable O.D. .37" x .24".

55-863B-3	3 ft.
55-863B-6	6 ft.
55-863B-12	12 ft.



CALRAD

55 Series - Video/CCTV Cables

Technical drawings and specifications are available for these cables. Please ask your Calrad sales representative for details.

HIGH QUALITY VIDEO/CCTV RG174 CABLE

Designed for high flexibility and sharp cornered applications, this 75 ohm cable is perfect for areas where a low profile cable is needed. **This is modeled after the Belden 8218 cable with comparable specifications.** Available in three different configurations. Molded 75 ohm connectors with 95% shielded coax. Cable OD = 0.151".

BNC Male to Male

55-630-3.....	3 ft.
55-630-6.....	6 ft.
55-630-12.....	12 ft.
55-630-25.....	25 ft.
55-630-50.....	50 ft.
55-630-75.....	75 ft.
55-630-100.....	100 ft.



BNC TO RCA Male to Male

55-631-3.....	3 ft.
55-631-6.....	6 ft.
55-631-12.....	12 ft.
55-631-25.....	25 ft.
55-631-50.....	50 ft.
55-631-75.....	75 ft.
55-631-100.....	100 ft.



RCA Male to Male

55-632-3.....	3 ft.
55-632-6.....	6 ft.
55-632-12.....	12 ft.
55-632-25.....	25 ft.
55-632-50.....	50 ft.
55-632-75.....	75 ft.
55-632-100.....	100 ft.



75 OHM COAX VIDEO/CCTV CABLE RG-59A/U

These 75-ohm RG59 coax interface cables have been designed for CCTV, broadcast video and any application where signal continuity needs to remain constant. They come with molded 75 Ohm BNC Male connectors with strain relief and a black PVC jacket to enhance wear in high use situations. The wire is 95% copper shielded.

BNC Male to Male

55-640-1.5.....	1.5 ft.
55-640-3.....	3 ft.
55-640-6.....	6 ft.
55-640-12.....	12 ft.
55-640-25.....	25 ft.
55-640-50.....	50 ft.
55-640-75.....	75 ft.
55-640-100.....	100 ft.



BNC to RCA Male to Male

55-641-1.5.....	1.5 ft.
55-641-3.....	3 ft.
55-641-6.....	6 ft.
55-641-12.....	12 ft.
55-641-25.....	25 ft.
55-641-50.....	50 ft.
55-641-75.....	75 ft.
55-641-100.....	100 ft.



RCA to RCA Male to Male

55-642-1.5.....	1.5 ft.
55-642-3.....	3 ft.
55-642-6.....	6 ft.
55-642-12.....	12 ft.
55-642-25.....	25 ft.
55-642-50.....	50 ft.
55-642-75.....	75 ft.
55-642-100.....	100 ft.



HIGH QUALITY VIDEO/CCTV RG174 CABLE

Designed for high flexibility and sharp cornered applications, this 75 ohm cable and connectors are perfect for areas where a low profile cable is needed. **This is also modeled after the Belden 1855A cable with comparable specifications** with molded 75 ohm connectors with 95% shielded coax. Cable OD = 0.151" CUL, CL2, CMR RATED



BNC Male to RCA Male

55-634-3.....	3 ft.
55-634-6.....	6 ft.
55-634-12.....	12 ft.
55-634-25.....	25 ft.



RCA Male to RCA Male

55-635-3.....	3 ft.
55-635-6.....	6 ft.
55-635-12.....	12 ft.
55-635-25.....	25 ft.



BNC Male to BNC Male

55-633-3.....	3 ft.
55-633-6.....	6 ft.
55-633-12.....	12 ft.
55-633-25.....	25 ft.

55 Series - Video/CCTV Cables

55-876

COAX JUMPER CABLE

(75 OHM) RG59U coax cable with Male F-connector to Male BNC connector. Shielded. 6 ft. long



55-874

COAX JUMPER CABLE

(75 OHM) RG59U coax cable with Male RCA connector to Male F-connector. Shielded. 6 ft. long



BNC COAX CABLES

(75 OHM) RG59U coax cable with Male-type BNC connectors each end.

- 55-879-2 2 ft.
- 55-879-3 3 ft.
- 55-879-6 6 ft.
- 55-879-12 12 ft.
- 55-879-15 15 ft.
- 55-879-20 20 ft.
- 55-879-25 25 ft.
- 55-879-50 50 ft.
- 55-879G-6 ... 6 ft., Gold-Plated
- 55-880G-10 10 ft., Gold-Plated
- 55-881G-20 20 ft., Gold-Plated



55-875

COAX JUMPER CABLE

(75 OHM) RG59U coax cable with BNC Male connector to RCA Male connector on other end. Shielded.

- 55-875-3 3 ft.
- 55-875-6 6 ft.
- 55-875-12 12 ft.
- 55-875-15 15 ft.
- 55-875-20 20 ft.



55-878G-2

2 ft. Gold-Plated for RG58 cable

55-878-3

3 ft. Nickel-Plated for RG58 cable

55-878G-3

3 ft. Gold-Plated for RG58 cable



COAX JUMPER CABLE WITH PUSH-ON "F" CONNECTORS

(75 OHM) RG59U coax cable with Male push-type F-connectors on each end. Solid pin center conductor.

- 55-882-2-PO 2 ft.
- 55-882-PO 3 ft.
- 55-883-PO 6 ft.
- 55-884-PO 12 ft.



55-877 RCA TO RCA COAX JUMPER CABLE

(75 OHM) RG59U coax cable with Yellow molded RCA Male plug on each end. Low Loss Cable for video and audio signals. Shielded.

- 55-877-3 3 ft.
- 55-877-6 6 ft.
- *55-877-8 8 ft.
- *55-877-10 10 ft.
- 55-877-12 12 ft.
- 55-877-15 15 ft.
- 55-877-20 20 ft.
- 55-877-25 25 ft.
- 55-877-50 50 ft.
- 55-877-75 75 ft.
- 55-877G 6 ft. Gold Plated



55-890 DIGITAL RF CABLE

This 75 ohm silver conductor cable soldered with silver solder, comes with high quality black chrome barrels with gold plated connectors. For use with HDTV equipment and digital cable modems. Overall cable O.D. 8mm, .315"

- 55-890-3 3 ft.
- 55-890-6 6 ft.
- 55-890-12 12 ft.
- 55-890-25 25 ft.



* While Quantities Last

CALRAD

55 Series - RF Cables

COAX JUMPER CABLES

RG59U or RG6 coax cable with molded Male "F" connectors each end.



Shielding specifications

for RG6 cables:

Conductor: 1.1mm copper
 Insulation: 5.0mm foam PE
 Brading 60%: 32 x 0.12mm CU
 Foil 100%: 0.025mm
 O.D. PVC: 6.8mm
 UL Approved.

RG6	
55-790	3 ft., Black
55-790-W	3 ft., White
55-791	6 ft., Black
55-791-W	6 ft., White
55-792	12 ft., Black
55-792-W	12 ft., White
55-793	15 ft., Black
55-793-W	15 ft., White
55-794	25 ft., Black
55-794-W	25 ft., White
55-795	50 ft., Black
55-795-W	50 ft., White
55-796	75 ft., Black
55-796-W	75 ft., White
55-797	100 ft., Black
55-797-W	100 ft., White

RG59

55-882-1	1 ft., Black
55-882-2	2 ft., Black
55-882	3 ft., Black
55-882-W	3 ft., White
55-883	6 ft., Black
55-883-W	6 ft., White
55-884	12 ft., Black
55-884-W	12 ft., White
55-885	25 ft., Black
55-885-W	25 ft., White
55-886	50 ft., Black
55-886-W	50 ft., White
55-888	75 ft., Black
55-888-W	75 ft., White
55-887	100 ft., Black
55-887-W	100 ft., White



These cables are available in UL approved versions. Ask your Calrad sales representative for details.

RG6 COAX JUMPER CABLES WITH PERMA-SEAL COMPRESSION "F" CONNECTORS

UL Black RG6 cable with 1.1mm center conductor. 60% tin plated braid and 100% foil shielding. These come with weather resistant Perma-Seal style compression connectors.

55-790-PS-BK	3 ft. Black
55-790-PS-WH	3 ft. White
55-791-PS-BK	6 ft. Black
55-791-PS-WH	6 ft. White
55-792-PS-BK	12 ft. Black
55-792-PS-WH	12 ft. White
55-793-PS-BK	15 ft. Black
55-793-PS-WH	15 ft. White
55-794-PS-BK	25 ft. Black
55-794-PS-WH	25 ft. White
55-795-PS-BK	50 ft. Black
55-795-PS-WH	50 ft. White
55-796-PS-BK	75 ft. Black
55-796-PS-WH	75 ft. White
55-797-PS-BK	100 ft. Black
55-797-PS-WH	100 ft. White



55-650 RG-6 COAX & MESSENGER CABLE

UL 75 ohm, 18 awg copper covered steel, 0.109" galvanized steel messenger inner shield PP-aluminum laminated overlapped tape bonded to dielectric, 67% tinned copper braid. 0.193" nom O.D. CPE dielectric, 0.275" nom O.D. black PVC jacket. UL AWM style 1354, 80° 300V. SLR 20dB min at 5-1000MHz. Meets NEC 820-V rating min. Color: black.

55-650-25	25 ft.
55-650-50	50 ft.
55-650-75	75 ft.
55-650-100	100 ft.
55-650-150	150 ft.



55-798

FLAT RG-6 CABLE

8" white, flat Female to Female "F" jumper cable. Thickness is $\frac{3}{32}$ ". Eliminates drilling through walls and conveniently runs under or over window and doors. Suitable for DBS installations in apartment buildings, cabins, motor homes and condominiums. Mounting adhesive-taped back. Nickel plated brass "F" connectors. Soft waterproof white PVC jacket. Size: .52" Width X .20" Thick



55-1050

SHIELDED CAMERA AV + POWER 20 METER EXTENSION CABLES 20 METERS

Provides video, audio, power signal thru one cable for Calrad or other video cameras. Used as a stand alone cable or to extend existing cables. Color coded cables, red=power, yellow = video, white=audio. Cable O.D. .217". Color is Off white.



55-1050-1

Audio/Video:.....Male to Male RCA connectors
 Power:.....Male to Female 2.1mm coax power connectors

55-1050-2

Audio/Video:.....Male to Female RCA connectors
 Power:.....Male to Female 2.1mm coax power connectors

55 Series - Speaker & Hook-Up Wire

55-846 FLAT SPEAKER WIRE

2 conductor speaker wire for under carpets and anywhere thickness is a problem. All lengths come in non-terminated spools.

16 Gauge

55-846-2.5-25.....16 Gauge, 25 ft.
55-846-2.5-50.....16 Gauge, 50 ft.
55-846-2.5-100.....16 Gauge, 100 ft.



STRANDED HOOKUP WIRE

Red and black multi-purpose 2 conductor hookup wire.

16 Gauge

55-848-5050 ft. (1.28 lbs)
55-848-100100 ft. (2.64 lbs)

18 Gauge

55-847-5050 ft. (0.94 oz)
55-847-100100 ft. (1.84 lbs)



SPEAKER WIRE

Clear jacket copper speaker 2 conductor wire.

18 Gauge

55-840-2525 ft. (0.38oz)
55-840-5050 ft. (0.86 oz)
55-840-100100 ft. (1.7lbs)
55-840-500500 ft. (8.0lbs)
55-840-10001000 ft. Spools

16 Gauge

55-841-2525 ft. (0.48 oz)
55-841-5050 ft. (1.24 lbs)
55-841-100100 ft. (2.3 lbs)
55-841-500500 ft.
55-841-10001000 ft. (23 lbs)

14 Gauge

55-842-2525 ft. (0.84 oz)
55-842-5050 ft. (2.06 lbs)
55-842-100100 ft. (3.8 lbs)
55-842-500500 ft. (20 lbs)
55-842-10001000 ft. (40lbs)

12 Gauge

55-843-5050 ft. (3.6 lbs),
55-843-100100 ft. (5.4 lbs)
55-843-500500 ft. (26 lbs)



ULTRAFLEX SPEAKER WIRE

Heavy duty copper speaker 2 conductor wire, very flexible.

12 Gauge

55-844-5050 ft. (3.56 lbs)
55-844-100100 ft. (9 lbs)
55-844-500500 ft.

10 Gauge

55-845-100100 ft. (11 lbs)
55-845-500500 ft.



55-655 12 GAUGE 'OFC'

SPEAKER CABLE

This low inductance and capacitance speaker cable accurately delivers the full power and frequency range of your receiver. Its larger, Oxygen Free Copper conductors are twisted to retard signal loss. Dark blue PVC rubber jacket with heavy gauge gold plated spade lugs with .25" openings.

Solderable spade lugs available separately, Calrad part number 30-655.

Lengths Available

55-655-1212 ft.
55-655-1515 ft.
55-655-2525 ft.
55-655-3535 ft.
55-655B-100..100 ft. Spool Bulk Cable



CL3 SPEAKER WIRE

55-849-2.....14 gauge, 2 conductor
55-849-4.....14 gauge, 4 conductor
55-850-2.....16 gauge, 2 conductor
55-850-4.....16 gauge, 4 conductor
55-851-2.....18 gauge, 2 conductor
55-851-4.....18 gauge, 4 conductor

CL3 speaker wire, UL approved. Excellent for home or commercial speaker installations. 500 ft. pull box. Specify 2 or 4 conductors when ordering.



Pull Box

CALRAD

55 Series - Audio Patch Cables

MIG Professional Series

Instrument Cables

MIG (mic, instrument, guitar) cable comes with 1/4" to 1/4" Male mono plugs mated to our low capacitance cable, designed with 95% "OFC" braided cable, with a 22 gauge center conductor, special high density filler surrounds each conductor to help strengthen the cables tensile strength. Terminated with Calrad's toughest connectors. A special non-conductive epoxy is applied over the connector followed by heat shrink tubing to finish the bonding process.



MIG Professional Series

Speaker Cables

MIG (mic, instrument, guitar) cable, comes with 1/4" to 1/4" Male mono plugs at each end. 14 gauge "OFC" center conductor, special high density filler surrounds each conductor to help strengthen the cables tensile strength. Terminated with Calrad's Elite series 1/4" plugs. A special non-conductive epoxy is applied over the connector followed by heat shrink tubing to finish the bonding process.



Non-Molded Connectors

Lengths Available

55-670-10	10 ft.
55-670-18	18 ft.
55-670-25	25 ft.



Lengths Available

14 GAUGE	
55-660-10	10 ft.
55-660-25	25 ft.
55-660-50	50 ft.
55-660-100	100 ft.

16 GAUGE

55-661-10	10 ft.
55-661-25	25 ft.
55-661-50	50 ft.
55-661-100	100 ft.

Molded Connectors

Lengths Available

55-675-15	15 ft.
55-675-20	20 ft.
55-675-25	25 ft.

55-720G MULTI-COLORED SHIELDED PATCH CABLE KIT - GOLD-PLATED

1/4" Stereo Male phone plugs at both ends. 8 different colored ends (red, orange, yellow, green, blue, black, gray, white) per pkg. Flexible black rubber jacket.

Lengths Available

55-720G	6 in.
55-720G-1	1 ft.
55-720G-2	2 ft.
55-720G-3	3 ft.
55-720G-6	6 ft.



55-721G MULTI-COLORED SHIELDED PATCH CABLE KITS GOLD-PLATED

1/4" Mono Male to RCA Male plugs. 8 different colored ends (red, orange, yellow, green, blue, black, gray, white) per pkg. Flexible black rubber jacket.

Lengths Available

55-721G-1	1 ft.
55-721G-2	2 ft.
55-721G-3	3 ft.



MULTI-COLORED SHIELDED PATCH CABLE KITS - GOLD-PLATED

1/4" Mono Male plug at both ends. 8 different color cables (Red, Orange, Yellow, Green, Blue, Black, Gray and White) per pkg.

Lengths Available

55-760G	6 in.
55-761G	1 ft.
55-763G	2 ft.
55-764G	3 ft.
55-765G	6 ft.

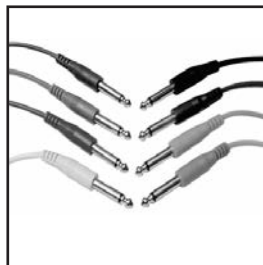

SHIELDED AUDIO CABLES

RCA Male plug to 1/4" mono plug. Gold plugs. Professional audio patch cables. Low-loss dielectric construction and extra shielding provide maximum noise protection.

Lengths Available

55-1020G	1 ft.
55-1021G	3 ft.
55-1022G	6 ft.



RIGHT ANGLE 1/4" AUDIO CABLES

Shielded cable with right angle 1/4" mono plugs each end.

Lengths Available

55-955	6 ft.
55-956	10 ft.
55-958	25 ft.



55-973

Right angle, 1/4" mono plug to a 1/4" mono inline jack. 6 ft. long

CALRAD

55 Series - Audio Cables

55-971 2 CONDUCTOR RIGHT ANGLE 1/4" CABLE

Right angle 1/4" Mono plug to stripped and tinned leads. 6 ft. long. Shielded.



55-912 HEADPHONE CABLE

1/4" Stereo plug to 3.5mm Stereo jack. Coil cord 6 ft. extended.



3 CONDUCTOR SHIELDED 1/4" STRAIGHT PLUG CABLE

1/4" Stereo plug to stripped and tinned leads. Shielded.

55-952 6 ft.

55-951 12 ft.



55-913 STEREO HEADPHONE EXTENSION CABLE

3.5mm Stereo plug to 1/4" Stereo jack. Coil cord 6 ft. extended.



55-914 SHIELDED STEREO AUDIO CABLE

3.5mm Male Stereo plug to a 1/4" stereo plug. Shielded.

Lengths Available

55-914-3 3 ft.

55-914-6 6 ft.

55-914-10 10 ft.



55-987 RETRACTABLE STEREO EXTENSION CABLE 20 FT.

1/4" Stereo plug to 1/4" Stereo jack. 20 feet length when extended.



55-936 3.5mm STEREO TO 1/4" SHIELDED MONO EXTENSION CABLES

Cables with 3.5 mm Stereo plug one end to 1/4" Mono plug other end. Shielded.

Lengths Available

55-936-3 3 ft.

55-936-6 6 ft.

55-936-10 10 ft.



SHIELDED RETRACTABLE EXTENSION CABLES

Straight 1/4" Mono plug to right angle 1/4" Mono plug.

55-957 Retracts 3 ft., Extends 15 ft.

55-959 Retracts 4 ft., Extends 25 ft.



3.5mm MONO TO 1/4" SHIELDED MONO AUDIO CABLES

3.5 mm Mono plug on one end and 1/4" Mono plug on other end. Shielded.

55-948 6 ft.

55-964 10 ft.



MICROPHONE EXTENSION CABLES

Shielded heavy duty 1/4" Mono plug one end to 1/4" Mono jack other end.

55-969 10 ft. Grey

55-960 25 ft. Black



CALRAD

55 Series - Audio Cables

3 CONDUCTOR 1/4" SHIELDED EXTENSION CABLE

1/4" Molded stereo plug to 1/4" Stereo jack.

55-858 12 ft.
55-859 25 ft.



SHIELDED AUDIO CABLES

Shielded dual 1/4" Mono plug each end.

55-974-3 3 ft.
55-974-6 6 ft.
55-974-10 10 ft.



55-986 STEREO HEADPHONE EXTENSION CABLE

1/4" stereo plug to 1/4" stereo jack. 20 ft.



SHIELDED AUDIO CABLES

Dual RCA Male plugs to dual 1/4" Male Mono plugs.

55-1025 3 ft.
55-1026 6 ft.
55-1027 10 ft.



55-950

3.5 mm mono plug, 6 ft. long to standard inline 1/4" Mono jack (shielded).



SHIELDED AUDIO CABLES

RCA Male plug to 1/4" Mono plug.

55-922 3 ft.
55-976 6 ft.
55-978 10 ft.
55-922-RT 3 ft., w/ R/A 1/4" plug
55-976-RT 6 ft., w/ R/A 1/4" plug
55-978-RT 10 ft., w/ R/A 1/4" plug



3 CONDUCTOR SHIELDED 1/4" PLUG

1/4" Stereo plug each end.

55-852B-3 3 ft.
55-853 6 ft.
55-854 12 ft.
55-854A 15 ft.
55-855 25 ft.
55-853G-6 6 ft., gold plated
55-854G 12 ft., gold plated
55-852-RT 3 ft., R/A plug one end
55-852-RR 3 ft., R/A plugs both ends
55-853-RT 6 ft., R/A plug one end
55-853-RR 6 ft., R/A plugs both ends
R/A = Right Angle



55-970

SHIELDED AUDIO CABLE

Right angle 1/4" Mono plug to right angle RCA Male plug. 6 ft. long (shielded).



55-954-COLOR SHIELDED RETRACTABLE CABLE

Extends to 20 ft. Comes in various attractive colors. Completely shielded with metal right angle 1/4" plug to a straight 1/4" metal plug (not molded). Colors: Black, Blue, or Yellow. Specify color.



PATCH BAY CABLES

1/4" Mono plug on each end. Shielded.

55-856 6 ft.
55-857 15 ft.



CALRAD

55 Series - Audio Cables

AUDIO JUMPER CABLES

3.5mm mono plug on each end.
Shielded cable.

55-939	1 ft.
55-940	3 ft.
55-941	6 ft.
55-942	10 ft.
55-943	25 ft.
55-943-50	50 ft.

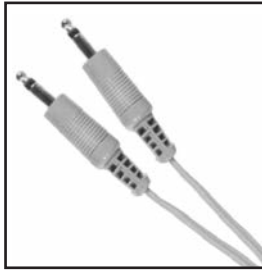

10 db RECORDING PATCH CORD, 6 ft. LONG

Built-in resistive 10 db attenuator prevents overload and impedance mismatch when recording from audio device to recorder. 3.5 mm plugs on each end.

55-909	mono to mono
55-896	stereo to stereo



STEREO MINI JUMPER CABLES

3.5 mm stereo plug on each end.
Shielded.

55-897-2	2 ft.
55-897-3	3 ft.
55-897-4	4 ft.
55-897-6	6 ft.
55-897-12	12 ft.
55-897G-15 (gold)	15 ft.
55-897-20	20 ft.
55-897-25	25 ft.
55-897-50	50 ft.
55-897-1000	bulk cable 1000 ft.
55-897RT-6	6 ft. Right angle plug to straight plug,
55-897G-RT-6 (gold)	6 ft. Right angle plug to straight plug
55-894 (gold)	6 ft. Right angle plugs both ends



55-920 SUB MINI SERIAL LINK, CONTROL-L EXTENSION CABLES

Stereo shielded audio and data control cable. This cable is used for AV digital editing and camera systems. Black rubber PVC jacket. 2.5mm stereo plug to 2.5mm stereo jack.

55-920-6	6 ft.
55-920-12	12 ft.
55-920-25	25 ft.
55-920-50	50 ft.
55-920-100	100 ft.



SHIELDED STEREO MINI EXTENSION CABLES

Audio cables with nickel-plated 3.5 mm stereo plug to 3.5 mm stereo jack.

55-921-3	3 ft.
55-921-6	6 ft.
55-921-10	10 ft.
55-921-12	12 ft.
55-921-15	15 ft.
55-937	20ft. with 3.5mm to 1/4" adapter
55-921-25	25ft.



SHIELDED AUDIO CABLES

55-949
3.5 mm mono molded plug to RCA plug. 6 ft. long.

55-965
12 ft. cable with 3.5mm mono 1/4" plug to RCA plug.



55-947
SHIELDED AUDIO CABLE
3.5mm mono molded plug to molded RCA jack. 6 ft. long.



AUDIO EXTENSION CABLES
3.5 mm mono plug to 3.5 mm mono jack. Shielded.

55-953	10 ft.
55-961	20 ft.



55-938
MINI 3.5mm PLUG TO 2.5mm PLUG
Molded 3.5 mm mono plug to molded 2.5 mm sub-miniature mono plug. Shielded. 3 ft. long.



55-898
STEREO MINI EXTENSION CABLES COILED
Cables with 3.5 mm stereo plug one end to 3.5 mm stereo jack other end. 25 ft. in length when extended.



Visit Calrad on the Web at: www.calrad.com

CALRAD

55 Series - Audio\Video Cables

55-869 4 CONDUCTOR SHIELDED RIGHT ANGLE 3.5mm A/V CABLE

Right angle Male to Male audio and video interface cable for portable A/V devices using 4 conductor 3.5mm input/output jacks. Carries composite video and L+R audio signals.

- 55-869B-3.....3 ft.
- 55-869B-6.....6 ft.
- 55-869B-12.....12 ft.



55-867B CAMCORDER A/V CABLE

Used in most Sony 8mm and digital camcorders to provide video and stereo audio signals in/out of the camera. 4 conductor 3.5mm right angle Male to 3 RCA plugs; video and L+R audio. Gold plated. Overall cable O.D. .34" x .113"

- 55-867B-3.....3 ft.
- 55-867B-6.....6 ft.
- 55-867B-12.....12 ft.



3.5mm 4 conductor plug



STEREO MINI "Y" ADAPTER CABLE

3.5 mm stereo plug to 2 molded RCA nickel-plated Male plugs (black). Shielded cable.

- 35-562.....10 in
- 55-899-1.....1 ft.
- 55-899-3.....3 ft.
- 55-899-6.....6 ft.
- 55-899-10.....10 ft.
- 55-899-12.....12 ft.
- 55-899-25.....25 ft.



55-946 SHIELDED AUDIO CABLE

3.5mm mono molded plug to stripped and tinned leads. 6 ft. long in a single jacket.

- 55-946-RT
Same as 55-946 with 3.5mm mono right angle plug (inset).



MOLDED MINI/SUB-MINI PLUG & CABLE

Mono or stereo miniature plug to stripped and tinned leads, 6 ft. long shielded cable in a single jacket.

- STRAIGHT PLUG VERSION**
- 55-7302.5 mm Mono Plug
- 55-7312.5 mm Stereo Plug
- 55-7323.5 mm Stereo Plug



- RIGHT ANGLE VERSIONS**
- 55-730-RT2.5 mm Mono Plug
- 55-731-RT2.5 mm Stereo Plug
- 55-732-RT3.5 mm Stereo Plug

55-944-2.5 55-944-3.5 MOLDED PLUG & CABLE (2.5 or 3.5 mm plug)

Plug to stripped and tinned leads, 6 ft. long (unshielded 24 gauge wire). Color: Black.

- 55-944-RT
Same as 55-944 with 3.5mm mono right angle plug (inset).



MOLDED PLUG & CABLE Coax plug to stripped and tinned leads, 6 ft. long (unshielded 20 gauge wire). Color: Black. White strip equals positive center.

- 55-837 1.7 mm Coax Plug
- 55-838 2.1 mm Coax Plug
- 55-838-RT R/A 2.1 mm Coax Plug
- 55-839 2.5 mm Coax Plug
- 55-839-RT R/A 2.5 mm Coax Plug
R/A = RIGHT ANGLE



MOLDED PLUG & CABLE Coax plug to stripped and tinned leads, 3ft. long (unshielded 22 gauge wire). Color: Black. White strip equals positive center.

- 55-838-3 2.1 mm Coax Plug



55-895 3.5mm STEREO Y CABLE

One (1) 3.5mm Stereo plug to two (2) 3.5mm Mono plugs. 78" long.



- 55-902
Stereo shielded cable assembly, 1/4" Stereo plug to 2 RCA Male plugs, 5 ft. long.

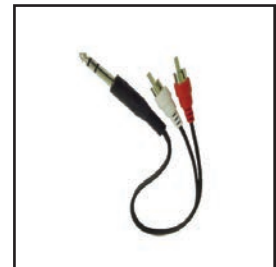

- 35-532
Stereo shielded cable assembly, 1/4" Stereo plug to 2 RCA Male plugs, 9-11" long.

- 55-997
"Y" ADAPTER CABLE
1/4" Stereo jack to dual RCA Male plugs, 12 ft..
- 35-593 10" version



CALRAD

55 Series - Audio \ MIDI \ AC Cables

55-975

Right angle 1/4" mono plug to pair of alligator clips. 6 ft. long (unshielded).

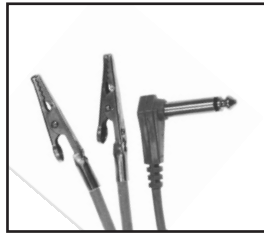

55-996

"Y" ADAPTER CABLE

1/4" Stereo jack to dual 3.5 mm mono plugs. Parallel wired. Shielded. 12" long.

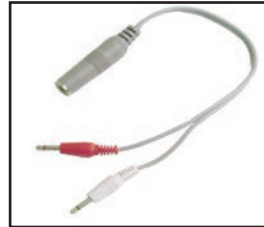

55-972

Right angle RCA plug to knurled microphone connector (not standard). Coupling ring can be screwed back to convert to Male connector. 6 ft. long (shielded).



55-782RT White AC Cables. For use with Plasma, LCD, DLP and Monitors. Shielded design reduces RFI/EMI interference. Female IEC to right angle AC Male. 10 AMP 125VAC 18 Gauge 3 conductor. UL and FT2 approved.

55-782RT-6-SHG.....6 ft.

55-782RT-12-SHG.....12 ft.

55-782RT-25-SHG.....25 ft.



55-788A

18 INCH DUAL POWER STRIP TRANSFORMER SPACE ELIMINATOR CABLE

3-Prong AC extension cable. Has AC plug on one end and AC jack on the other end. (UL listed, 18 gauge).



55-788B POWER STRIP TRANSFORMER SPACE ELMINATOR WITH A.C. FEEDTHROUGH PLUG

Same function as 55-788 but allows the AC outlet to be used for two AC adapters. (UL listed, 18 gauge 3 conductor). 6 inch lead of SVT cable. Length 10.5 inches overall.



55-904 DIN CABLE

3-pin DIN plug to (1) RCA plug. 6 ft. long.



STEREO MIDI CABLES

Shielded stereo midi patch cables with 5-pin DIN plug on each end, 180° pattern.

55-9066 ft.

55-906A15 ft.



180° MIDI CABLES - SHIELDED AUDIO CABLES

5-pin DIN plug to 5-pin DIN jack.

55-9086 1/2 ft.

55-908A15 ft.



55-911 DIN CABLE

5-pin DIN Male to four RCA jacks. 6 inches long.



55-830 COMPUTER INTERCONNECT CABLE

Has (2) 3.5 mm plugs on one end, and (1) 3.5mm plug and (1) 1/4" plug other end. Color-coded, 4 ft. long. Shielded.

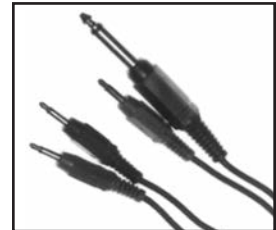

55-831 COMPUTER INTERCONNECT CABLE

Has 5-pin (180°) DIN plug on one end, and (1) 1/4" plug, (1) 3.5 mm plug and (1) 2.5 mm plug other end. Shielded, 4 ft long.



55-834 MIDI INTERFACE CABLE

5-pin DIN jack to (4) RCA-type pin plugs, 6 inches long midi cable.



POWER STRIP TRANSFORMER SPACE ELIMINATOR CABLE

55-788, 6 Inch

55-788-1, 1 ft.

55-788-2, 2 ft.

55-788-3, 3 ft.

55-788-6, 6 ft.

3-Prong AC extension cable. Has AC plug on one end and AC jack on the other end. (UL listed, 18 gauge).



CALRAD

55 Series - AC Cables, Bulk Video Cable

55-782

AC \ IEC COMPUTER POWER CABLE (STRAIGHT)

- 55-782-1 1 ft.
- 55-782-1.5 18 in
- 55-782-2 2 ft.
- 55-782-3 3 ft.
- 55-782-6 6 ft.
- 55-782-12 12 ft.



AC \ IEC COMPUTER POWER CABLE (RIGHT ANGLE)

- 55-782RT-1.5 18 in
- 55-782RT-3 3 ft.
- 55-782RT-6 6 ft.
- 55-782RT-12 12 ft.

UL listed, 3-Prong AC computer cable. Right Angle, three pin Male AC plug to computer IEC Female inline jack. 18 gauge, Black.



55-785

AC \ IEC RIGHT ANGLE POWER CABLE

UL listed, right angle 3-prong AC computer cable. AC plug on one end to right angle computer IEC jack. 18 gauge with black jacket. Available in 3ft or 6 ft lengths

- 55-785-3 3 ft.
- 55-785-6 6 ft.

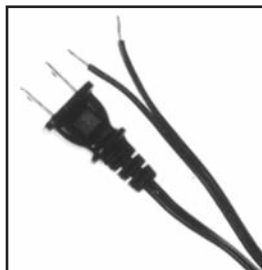

55-781

3 PRONGED FEMALE TO IEC AC MALE ADAPTER

UL listed, IEC Male plug to 3 prong grounded Female inline jack. (6 ft. long, Black)



55-780

AC POWER CABLE

3-Prong, extra heavy duty AC cord. Round 16 gauge wire has stripped and tinned ends. (6 ft. long—Black). UL and CSA approved.

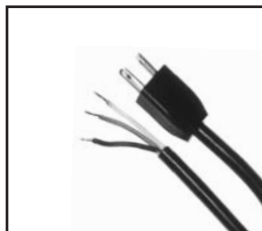

55-784

AC POWER CABLE

UL listed, 2-Prong, AC Replacement Cable with stripped and tinned leads. (18 gauge, 6 ft. long). Heavy Insulation. Color is Black.



55-783

AC IEC

EXTENSION CABLE

UL listed, 3-Prong AC computer extension cable. AC IEC Male plug on one end and IEC Female jack on other end. (18 gauge, 6 ft. long, Black).



55-786

AC Extension

Cables 16 Gauge,

UL listed, indoor 2 Prong standard AC extension cord with dual sided jacks, Color is White.

Lengths Available

- 55-786-3 3 ft.
- 55-786-6 6 ft.
- 55-786-10 10 ft.
- 55-786-12 12 ft.
- 55-786-15 15 ft.
- 55-786-25 25 ft.



55-787

AC Extension

Cables 14 Gauge

UL listed, Indoor/Outdoor 3 prong standard AC extension cord with tripple sided jacks, Color is Black.

Lengths Available

- *55-787-50 50 ft.
- *55-787-75 75 ft.
- *55-787-100 100 ft.

*While Quantities Last



55-787A Extension Cord

14AWG UL Listed 3 Cond.

SJTW JACKET Rated FT2

- 55-787A-6 6 ft.
- 55-787A-10 10 ft.
- 55-787A-15 15 ft.
- 55-787A-25 25 ft.
- 55-787A-50 50 ft.
- 55-787A-75 75 ft.
- 55-787A-100 100 ft.



55-615B FLAT HIGH QUALITY COMPONENT VIDEO CABLE

Low loss 75 ohm component video cable. 100% foil, 70% braided shielding, stranded center conductor. Silver jacket, 3 color (RGB) foam dielectric for easy termination. Capacitance 17pF/ft. jacket O.D. .71" X .26". Bandwidth 1Ghz. attenuation 9.3db at 1Ghz per 100 ft. Velocity of propagation 75%. Available in 330 ft. spools.



Silver Color Jacket

CALRAD

55 Series - Bulk Audio & Video Cable

COMPONENT, SHIELDED VIDEO CABLE

55-610B, 3 COAX CABLES 55-611B, 5 COAX CABLES

Oxygen free copper "OFC". Miniature shielded 75 ohm video coax cable, red, green, blue, black, white. Multi-stranded tension barring filler for superb strength. Flexible .05" thick black rubber jacket. Overall cable diameter .65", individual coax cable diameter .20". Individual cable dielectric insulation O.D. .118". Nominal capacitance 17pf/ft. Shielding 93% braided copper. Nominal attenuation MHz dB/100'. 100MHz-4.6dB, 400MHz-9.18dB. Nominal velocity of propagation 80%. Use Calrad 75-607, 75-801G-75 75 ohm BNC connectors, 30-291, 30-427, 30-390 RCA connectors. 55-610 Available in 500' spools, 55-611 available in 250' & 500' spools.

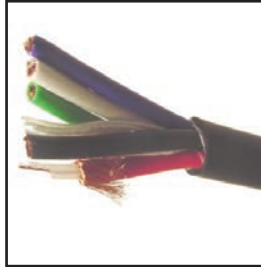

55-716B

8mm SHIELDED SILVER PLATED DIGITAL AUDIO VIDEO CABLE

Bulk cable in 250' spools.

Low capacitance, precision 110 ohm construction for sharp and accurate digital signal transfer. Specially designed for excellent performance over long runs. Tightly wound braided shielding resists leakage and outside interference. Weight is 16 lbs. per spool. Cable O.D. .315".



55-612B, 55-866B, SHIELDED HDTV RGB+SYNC VIDEO CABLE

HDTV RGB+SYNC cable color coded red, green, blue, black, and white. Tin plated copper conductors. Low loss miniature 75 ohm coax cables individually shielded and with overall braided shielding plus multi-strand tension barring filler for superb strength. High strand count for accurate signal transfer. Cable overall O.D. .37". Individual cable O.D. .1". Flexible black PVC jacket. Available in spools of 100' & 250 feet. weight of 8.7 lbs. or 250' spools weight of 21.7 lbs. Use Calrad connectors 30-291, 75-801G-75.



55-770GB

MOLDED MINIATURE SHIELDED S-VIDEO CABLE

Dual miniature 75 ohm low loss S-Video cable. OFC braided shields and center conductors. Color coded center conductors for easy signal identification. Black PVC rubber jacket. Overall cable O.D. .23" x .12". Individual cable O.D. .115". Available in 1000' spools.

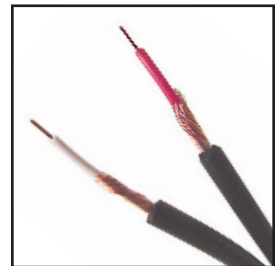

55-862B

MOLDED COMPOSITE VIDEO/STEREO AUDIO CABLE

Molded video and stereo audio cable available in spools. This cable provides a foil over stranded copper, the audio is copper braided shielding with color coded center conductors for easy signal identification. Black PVC jacket. Overall cable O.D. .49" x .23". Available in 250' spools.



55-771GB

8mm LOW LOSS S-VIDEO CABLE

Color ID for luminance and chrominance signals. Red/white miniature 75 ohm coax cable with thick PVC jacket. Capacitance per foot 16.9pf. Insulation foamed PE. Available in 330' spools. Weight is 19 lbs. per spool. Overall cable O.D. .315", individual cable O.D. .172".

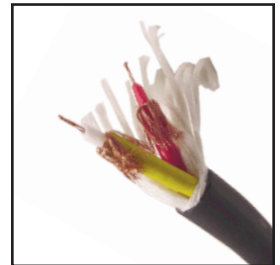

55-705B

SHIELDED 6mm DUAL MOLDED AUDIO CABLE

Triple shielded audio cable available in 250' or 330' spools. This cable is perfect for any stereo audio feed for home theater systems. 2 braided shields and 100% foil coverage. Weight is 19 lbs. per spool. Cable O.D. .47" x .23".

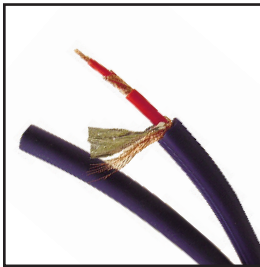

55-868B

MOLDED S-VIDEO & STEREO AUDIO CABLE

Molded S-video and stereo audio shielded cable available in 250' spools. This cable provides 2 miniature 75 ohm shielded video cables for SVHS (chrominance, luminance) and individually shielded cables for L+R audio signals. Black PVC jacket with 95% braided shielding. Overall cable O.D. .517" x .2".



55-715B

8mm DOUBLE SHIELDED VIDEO 'OFC' CABLE

Audio cable available in 500' spools. Thick rubber jacketed audio cable. 100% foil shield with 95% braided 'OFC' oxygen free copper shielding and center conductor. Weight is 25 lbs. per spool. Cable O.D. 8mm, .315".

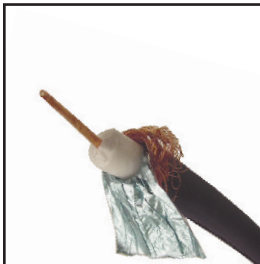

55-897B

MINIATURE SHIELDED DUAL MOLDED AUDIO CABLE

2 Conductor shielded miniature dual audio cable. Overall cable O.D. .19" x .1". Individual cable O.D. .095". Available in 1000' spools. Weight 8.6 lbs. per spool.



CALRAD

55 Series - USB, Firewire Cables, USB Extenders

72-125 VERSION 2.0 USB TYPE A CABLES

Universal Serial Bus 2.0 (USB 2.0). USB 2.0 increases signal transmission from standard USB 1.1 topping out at 12Mb/s up to 480Mb/s for USB 2.0. These cables are completely backward compatible with standard USB ports, so there isn't any need to worry that you will not be able to use USB 2.0 cables on the standard USB products you already own.

Lengths Available

72-125-6	6 ft.
72-125-10	10 ft.
72-125-15	15 ft.



72-126 USB 2.0 TYPE A/B CABLES

Universal Serial Bus 2.0 (USB 2.0) brings a new standard of speed to the USB market. These new highspeed USB cables give more versatility to computers and peripherals than ever before. USB 2.0 increases signal transmission from standard USB 1.1 topping out at 12Mb/s up to 480Mb/s for USB 2.0. The cables are completely backward compatible with standard USB ports, so there isn't any need to worry that you will not be able to use USB 2.0 cables on the standard USB products you already own.

Lengths Available

72-126-6	6 ft.
72-126-10	10 ft.
72-126-15	15 ft.



FIREWIRE/HAVI CABLES

This type of IEEE 1394 cable carries up to over 400MBps of bandwidth.

Lengths Available

72-120-6	4-pin/4-pin, 6 ft.
72-120-10	4-pin/4-pin, 10 ft.
72-120-15	4-pin/4-pin, 15 ft.
72-121-6	6-pin/4-pin, 6 ft.
72-121-10	6-pin/4-pin, 10 ft.
72-121-12	6-pin/4-pin, 12 ft.
72-121-15	6-pin/4-pin, 15 ft.
72-122-6	6-pin/6-pin, 6 ft.
72-122-10	6-pin/6-pin, 10 ft.
72-122-12	6-pin/6-pin, 12 ft.
72-122-15	6-pin/6-pin, 15 ft.



6 Pin 4 Pin Firewire Pinouts

72-127 USB 2.0 Type Male to Type A female extension Cables

Lengths Available

72-127-6"	6 Inches
72-126-6	6 ft.
72-126-10	10 ft.
72-126-15	15 ft.



Mini USB Adapter Cables

These mini USB 2.0 cables allow the user to interface their digital camera or other products to standard USB type A or B connectors. Available in 4 and 5 pin configurations.

Versions Available

Mini USB 5 Pin Male to USB Type A

72-260-3	3 ft.
72-260-6	6 ft.

Mini USB 4 Pin Male to USB Type A

72-261-3	3 ft.
----------	-------

Mini USB 4 Pin Male to USB Type B

72-262-3	3 ft.
----------	-------

Mini USB 4 Pin Male to Mini USB 4 Pin Male

72-263-3	3 ft.
----------	-------

Mini USB 5 Pin Male to Mini USB 5 Pin Male

72-264-3	3 ft.
----------	-------

72-264-6	6 ft.
----------	-------

USB 1.1 OVER CAT5 EXTENDER

72-131



5 Pin 4 Pin Mini USB Pinouts

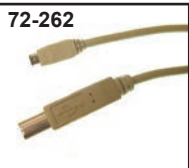
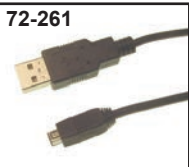

72-128 USB TYPE A EXTENDER CABLE

72-128.....16 ft.

72-128-26.....26 ft.

Embedded USB transceiver cable prevents signal loss. Extends the cable length of any USB device by an additional 16 feet. Daisy chain up to 4 additional extender cables to increase your run by up to an additional 80 ft. Male to Female USB type A connectors. Available in 16 and 26 foot options.



72-131 USB 1.1 OVER CAT5 EXTENDER CABLE

USB Extender, USB Over Ethernet Cat5 / Cat6.USB over ethernet USB extender.

Connects USB devices up to 50m over a single Cat 5 or Cat 6 ethernet cable. USB 1.1 Compliant. USB A male to USB A female connectors. Supports Windows 2000/XP/Vista Mac OS9.x and higher. No external power required.



72-132 USB 2.0 OVER CAT5 EXTENDER CABLE

This cable can be used to extend the distance between a USB device and a host computer by up to 150 feet. It consists of 2 pieces of a local unit with USB Type A Male (host computer side) and a remote unit device side) with built-in USB Type A Female connector. Standard CAT5/5e/6 network cable (UTP or STP) is used to connect the two units together. No External power required.



CALRAD

60 series - Analog Panel Meters

60-118 THROUGH 60-133 2³/₈" FULL VIEW PANEL METERS

Designed for modernistic equipment. Beautiful appearance, easy to read D'Arsonval type movement, accuracy within 2%. Will mount in panels up to ³/₁₆" thick, has zero adjustment screw. Size: 2³/₈" x 1³/₄" x 1¹/₄" deep, including terminals and will mount into 1¹/₂" hole. Illumination Kit available for all of this series (60-149). Available in bulk or packaged. Comes with meter cut out template and mounting hardware. 60-200 Mounting hardware only for Calrad meters 60-118 - 60-148.

- | | |
|---|--|
| 60-118..... 0-1 mA, DC resistance: 1mA/120Ω | 60-129..... 0-50 μA, DC resistance: 50μA/2400Ω |
| 60-121... 0-15 Vdc, DC resistance: 1mA/120Ω+15kΩ | 60-130..... 0-100 μA, DC resistance: 100μA/1200Ω |
| 60-122... 0-30 Vdc, DC resistance: 1mA/120Ω+30kΩ | 60-133 VU Meter, DC resistance: 600Ω+DiodeBr.+3.9kΩ/120Ω |
| 60-125 0-150 Vac, DC resistance: 1mA/120Ω+DiodeBr.150kΩ | 60-149..... Illumination Kit, 6vdc at 50mA |
| 60-127..... 50-0-50 μA, DC resistance: 50μA/1200Ω | |



60-134 THROUGH 60-148 3" FULL VIEW PANEL METERS

Designed for modernistic equipment. Beautiful appearance, easy to read D'Arsonval type movement, accuracy within 2%. Will mount in panels up to ³/₁₆" thick, has zero adjustment screw. Size: 3¹/₈" x 2¹/₂" x 1¹/₈" deep, including terminals and mounts into 1²⁵/₃₂" hole. Illumination Kit available for all of this series (60-149). Available in bulk or packaged. Comes with meter cut out template and mounting hardware.

- | | |
|---|--|
| 60-134..... 0-1 mA, DC resistance: 1mA/120Ω | 60-142..... 50-0-50 μA, DC resistance: ±50μA/120Ω |
| 60-136.... 0-15 Vdc, DC resistance: 1mA/120Ω+15kΩ | 60-144..... 0-50 μA, DC resistance: 50μA/2400Ω |
| 60-137.... 0-30 Vdc, DC resistance: 1mA/120Ω+30kΩ | 60-148..... VU Meter, DC resistance: 600Ω+DiodeBr.+3.9kΩ |
| 60-140..... 0-150 Vac, DC resistance: 1mA/120Ω+DiodeBr.+150kΩ | 60-149..... Illumination Kit, 6 Vdc at 50mA |



60-150 THROUGH 60-175 1³/₄" PANEL METERS

Clear plastic face, D'Arsonval type movement, 1.73" square face. Meters fit into 1¹/₂" diameter hole in panel and are calibrated to be accurate within 2%. Has zero set screw adjustment. Will enhance the looks of any equipment on which it is used. Listed below are the following sizes. Available in bulk or packaged. Comes with meter cut out template and mounting hardware. 60-201 Mounting hardware only for Calrad meters 60-150 - 60-175.

- | | |
|--|--|
| 60-150..... 0-15 Vac, DC resistance: 1mA/120Ω+DiodeBr.+15kΩ | 60-161... 0-200 mA DC, DC resistance: 10mA/3Ω+par.Shunt 0.4x55 |
| 60-151..... 0-150 Vac, DC resistance: 1mA/120Ω+DiodeBr.+150kΩ | 60-163... 0-500 mA DC, DC resistance: 10mA/3Ω+par.Shunt 0.5x40 |
| 60-152..... 0-15 Vdc, DC resistance: 1mA/120Ω+15kΩ | 60-165..... 0-50 μA DC, DC resistance: 50μA/2400Ω |
| 60-153..... 0-30 Vdc, DC resistance: 1mA/120Ω+30kΩ | 60-166..... 0-100 μA DC, DC resistance: 100μA/1200Ω |
| 60-154. 0-200 Vdc, DC resistance: 1mA/120Ω+200kΩ | 60-167..... 0-200 μA DC, DC resistance: 200μA/600Ω |
| 60-155. 0-300 Vdc, DC resistance: 1mA/120Ω+300kΩ | 60-168..... 0-500 μA DC, DC resistance: 500μA/300Ω |
| 60-156. 0-500 Vdc, DC resistance: 1mA/120Ω+500kΩ | 60-169 50-0-50 μA DC, DC resistance: ±50μA/1200Ω |
| 60-158..... 0-1 mA DC, DC resistance: 1mA/120Ω | 60-171.. 0-10 Amp DC, DC resistance: 10mA/3Ω+par.Shunt 1.3x19 |
| 60-159..... 0-10 mA DC, DC resistance: 10mA/3Ω | 60-172.. 0-30 Amp DC, DC resistance: 10mA/3Ω+par.Shunt 2.3x24 |
| 60-160..... 0-100 mA DC, DC resistance: 10mA/3Ω+par.Shunt 0.2x46 | 60-175..... VU, DC resistance: 600Ω+DiodeBr.+3.9kΩ |

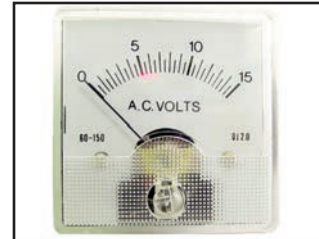

60-180 THROUGH 60-182 2" EDGEWISE PANEL METERS

Clearview, precision movements, moving coil nuclear magnetic steel type. Zero set screw adjustment. Accurate within 2%. Available in bulk or packaged.

- | |
|--|
| 60-180 (EW2) "S"..... ±100μA/650Ω, red pointer. Internal Resistance 150 ohms nominal |
| 60-181 (EW2) Balance..... 200μA/650Ω, red pointer. Sensitivity 100 μA, Resistance 600 ohms |
| 60-182 (EW2) VU |

Specifications

Mounting Centers..... 1¹⁵/₁₆" Overall Depth.....1⁷/₁₆" Overall Height.....1¹/₈"



60-187 AND 60-188 3¹/₄" EDGEWISE PANEL METERS

Compact size, easy to read. Moving coil type with zero set screw adjustment. Used on most transistorized equipment. Listed below are the following sizes and specifications. Available in bulk or packaged.

- | |
|---|
| 60-187 (EW75) VU 500μA/650Ω, red pointer. Calibrated and damped in accordance with standard vu meter practice |
| 60-188 (EW75) Battery..... 200μA/650Ω, red pointer. Sensitivity 130 μA, Internal Resistance 600 ohms |

Specifications

Mounting Centers.....1³/₁₆" Depth.....1¹/₈"
Height.....³/₄" Back of Panel.....⁷/₁₆"



60-190 MINI PILOT METER

¹/₂" diameter, mounts into ⁷/₁₆" hole. ¹/₂" depth behind panel. Moving coil type construction. Movement: 0-500μA. Internal Resistance: 700Ω abd 0-1mA/350Ω red pointer with red to green face. Red and black wires 4" long. M106-230 "Intensity". Center sensitivity 375μA. Resistance 500Ω. Available in bulk or packaged.



CALRAD

65 Series - VOM Multimeters

65-263 DIGITAL MULTIMETER

3.5 digit DMM has 1/2" high LCD display. 20 position rotary switch sits in compact, shirt pocket size meter. Has diode, transistor and continuity tester. Has 10 amp DC current range and includes temperature probe good from -40 to 1000 C High impact yellow plastic case. Comes with fuse protection and 9 volt battery.

Specifications:

DC Volt.....0-200mv -2V-20V-200V-1000V	Test Leads.....(Red & Black) 24 "
AC Volt.....0-250V - 750V	Battery.....9V battery(included)
DC Current...0-2000uA -20ma-200ma-10A	Weight.....0.5 lbs
AC Current.....No AC Current function	Size....5" L x 2 5/8" W x 7/8" D
Case Color.....Yellow	
Resistance 0 - 200 ohms -2000 -20K-200K -2000K	



65-264 MINI DIGITAL MULTIMETER

Pocket portable multi-meter with 5 functions and 19 ranges. Each test position is quickly and easily selected with a simple turn of the selector switch. 3.5 digit, 7 segment, 0.5" high LCD display with polarity. Diode and transistor tester. Overload fuse protection and low battery indicator circuitry. 19 position rotary range switch. High impact resistant protective yellow case.

Specifications:

DC Volt:.....0-200Mv-2000Mv-20V-200V-1000V
AC Volt:.....100Mv-200V: 1V-750V Max 750V RMS Peak-Peak
DC Current:.....0-200uA-2000uA-20m-200m-10A
Resistance:0-200-2000-20K-200K-2000K
Test Leads:(Red & Black) 18" Long
Weight:.....6 oz.
Dimensions:25/8"(W) x 45/8"(L) x 15/16"(D)
Case Color/Material:Yellow and Plastic



65-266 DIGITAL MULTIMETER

3.5 digit adjustable-display DMM with 1" high contrast LCD display. Diode and 50 ohm continuity beeper, transistor tester. Overload fuse protection and low battery indicator circuitry. 30 position rotary range switch with separate data hold switch. High impact resistant protective yellow holster.

Specifications:

DC Volt..... 0-200mv-2V-20V-200V-1000V	Test Leads (Red & Black) 38"
AC Volt..... 0-2V-20V-200V-700V	Battery 9V battery (included)
DC Current 0-2ma-20ma-200ma-20A	Weight..... 1.25 lbs.
AC Current 0-20ma-200ma-20A	Size 7.75"L x 3.75"W x 1.625"D
Case Color..... Black	Capacitance..... 0-2nf-20nf-200nf-2uf-20uf
Resistance 0-200ohms-2K-20K-200K-2M-20M-200M	



65-270 HDMI CABLE TESTER

Allows you to test your HDMI cables even if they are installed in the wall. Sold as a transmitter and receiver pair. The receiver unit has 9 easy to read L.E.D's. Provides automatic independent testing for TDMS Red, TDMS Green, TDMS Blue, TDMS Clock, CEC, 12C Clock, 12C Data, 5Vdc, and Hot Plug. Can be used to test DVI cables by using the optional Calrad 35-716 DVI to HDMI adapter, sold separately. Works with all formats of HDMI and DVI cables. Operates on one 9 volt battery (not included). Dimensions: Transmitter: H 5.3" X W 2.75" X D 1.1", Receiver: H 5.3" X W 2.75" X D 1.1".

35-716
HDMI Male to DVI-D
Female cable adapter.
Gold plated contacts.
6" Length.



CALRAD

65 Series - Test Leads

90-767

TEST CLIP SET

Thin wire kit of 10 leads, 15" long. Miniature insulated alligator clip each end. 2 each of 5 colors: White, Black, Red, Green, Yellow.



90-764

TEST CLIP SET

Same as 90-767, but with medium weight clips and wire. Colors: White, Black, Red, Green, Yellow.

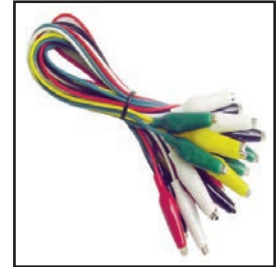

90-770

HEAVY DUTY TEST CLIP SET

Heavy duty, flexible wire, insulated clips. Four 30" cables. Colors: Black, Red, Green, Yellow.



90-781

TEST CLIP SET

Features 5 color-coded leads, terminated with wire hooks for hands free testing. Colors: White, Black, Red, Green, Yellow.



65-295A

TEST LEADS

Molded, 3 ft. long, extra flexible, strain relief at each end to minimize breakage, test prods both ends.



65-308

TEST LEADS

Same as 65-295A, but molded banana plugs one end to test prods. 3 ft. long.



RUBBER INSULATED ALLIGATOR CLIPS

Sturdy nickel plated jaws with strong spring and hard bite. 1 1/2" long.

90-765.....Black



RUBBER INSULATED ALLIGATOR CLIPS

Sturdy nickel plated jaws with strong spring and hard bite. 1 1/2" long.

90-766.....Red



90-768

ALLIGATOR CLIPS

Kit of 5 alligator clips. Nickel plated with screw terminals. Also fits banana plugs.



90-771 2 Black, 2 Red

90-771-BK 2 Black

90-771-RD 2 Red

ALLIGATOR CLIPS WITH INSULATED HANDLES

Insulated alligator clips. Screw terminals. Also fits banana plugs.



CALRAD

70 Series - Telephone Accessories

FLUSH MOUNT, SINGLE-JACK MODULAR WALL PLATES

For new construction or conversion to modular instruments. Screw terminals.

- 70-403-AL4-Wire Almond
- 70-403-ALS 4-Wire Almond Smooth
- 70-403-BR4-Wire, Brown
- 70-403-S4-Wire, Ivory, Smooth
- 70-403-WS...4-Wire, White, Smooth
- 70-426-S6-Wire, Ivory, Smooth
- 70-426-W6-Wire, White
- 70-426-WS...6-Wire, White, Smooth
- 70-530-S8-Wire, Ivory, Smooth
- 70-530-W8-Wire, White
- 70-530-WS...8-Wire, White, Smooth

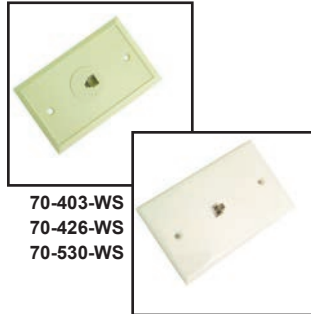

70-403-WS
70-426-WS
70-530-WS

FLUSH MOUNT, DOUBLE-JACK MODULAR WALL PLATES

Double jack wall plates designed to accept two modular plugs. Screw terminals.

- 70-410-ALS4-Wire Almond, Smooth
- 70-410-ID4-wire Ivory Designer
- 70-410-S 4-Wire, Ivory, Smooth
- 70-410-WD ..4-Wire White Designer
- 70-410-WS. 4-Wire, White, Smooth
- 70-404-W 6-Wire, White
- 70-404-S 6-Wire, Ivory, Smooth
- 70-404-WS. 6-Wire, White, Smooth
- 70-531-S 8-Wire, Ivory, Smooth
- 70-531-W 8-Wire, White
- 70-531-WS. 8-Wire, White, Smooth

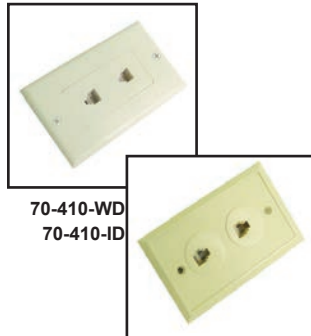

70-410-WD
70-410-ID

FLUSH MOUNT, DESIGNER STYLE MODULAR WALL PLATES

Wall plates designed to accept modular plugs. Screw terminals.

- 70-570-WD .White Designer Single, 4-Wire
- 70-570-ID Ivory Designer, Single, 4-Wire
- 70-571-ID Ivory Designer, Single, 6-Wire



PHONE/TV WALL PLATE

Plastic wall plate that has an F-81 connector for TV and a telephone jack all in one plate.

- 70-534-ALS Almond, Smooth
- 70-534-ID. Ivory Designer
- 70-534-S Silver
- 70-534-W White
- 70-534-WD White Designer
- 70-534-WS White, Smooth

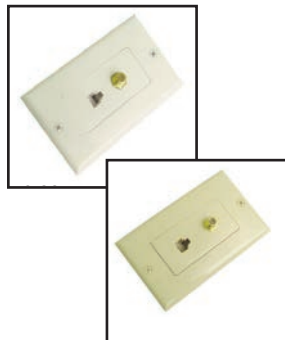

70-535 SOLID OAK WALL PLATE

One 4-wire outlet.

70-536 SOLID OAK WALL PLATE

Two 4-wire outlets.

70-537 SOLID OAK WALL PLATE

Single Gold F-81 connector.

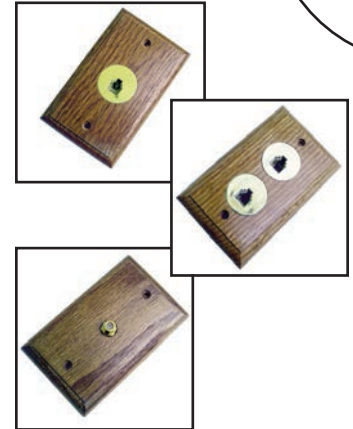

PLASTIC WALL PLATE

- 75-493 Ivory
- 75-493-W White
- 75-493-2 2GHZ Ivory
- 75-493-2-WH 2GHZ White
- 75-493-ID Ivory Designer Style
- 75-493-WD White Designer Style

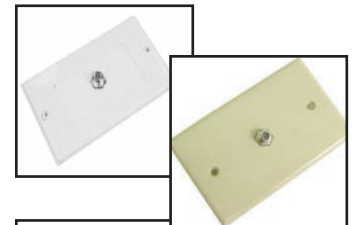

STAINLESS STEEL WALL PLATE 75-493-SS

Single Gold F-81 connector Wall Plate.

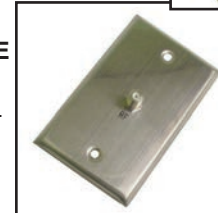

DESIGNER STYLE WALL PLATE WITH SINGLE F-81 CONNECTOR.

Wall plates with dual F-81 connectors. 1 GHZ

- 75-489-IVIvory
- 75-489-WWhite
- 75-489-IDIvory Designer
- 75-489-WDWhite Designer
- 75-489-IV-22 GHZ Ivory
- 75-489-W-22 GHZ White

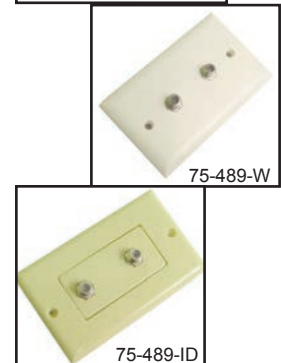

WALL PHONE MOUNTING PLATES

For mounting wall phones.

- 70-427Single, Ivory
- 70-427-MSingle, Metal
- 70-427-WSingle, White

70-5523-way modular wall plate a modular wall phone jack equipped with additional jacks allowing you to connect auxiliary devices or extension telephones in addition to mounting a wall plate.



28 Series - Cable Distribution Wall Plates



**28-CEDH1-BK
Black Single Gang Cable
Distribution Wall Plate**

Plastic single gang hood provides a versatile method of passing multiple cables from behind the wall to equipment. Hoods may be installed in our 70-558 or 70-568 low voltage brackets and are compatible with our 28 series designer style single and multi gang wall plates. These hoods may be installed with the scoop facing in or out of the wall, to suit a variety of needs.

Dimensions: W 4.13" X L 1.5" X D 1.5"

Cable Opening: W 1.2" X L 2.3"
Color: Black

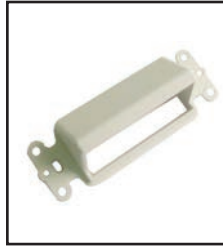

**28-CEDH1
Single Gang Cable
Distribution Wall Plate**

Plastic single gang hood provides a versatile method of passing multiple cables from behind the wall to equipment. Hoods may be installed in our 70-558 or 70-568 low voltage brackets and are compatible with our 28 series designer style single and multi gang wall plates. These hoods may be installed with the scoop facing in or out of the wall, to suit a variety of needs.

Dimensions: W 4.13" X L 1.5" X D 1.5"

Cable Opening: W 1.2" X L 2.3"
Color: White



**28-CER-1
Single Gang Scoop Style
Cable Distribution Wall Plate**

Plastic single gang hood designed for post or retrofit cable installations as well as for cables with large connectors. The lower portion of this bulk wire wall plate is removable so you can install the plate after the cables have been installed or connected. Can be used with our 70-558 or 70-568 low voltage brackets. Squared single port for maximum cable capacity. This retrofit plate is reversible so you can have the scoop inside or outside of the wall to suit a variety of needs.

Dimensions: 2.87" W X 4.63" L X 1.56" D

Cable Opening: W 1.56" X H .095"
Color: White



**28-CER-2
Double Gang Scoop Style
Cable Distribution Wall Plate**

Plastic dual gang hood designed for post or retrofit cable installations as well as for cables with large connectors. The lower portion of this bulk wire wall plate is removable so you can install the plate after the cables have been installed or connected. Can be used with our 70-559 or 70-569 low voltage brackets. Squared single port for maximum cable capacity. This retrofit plate is reversible so you can have the scoop inside or outside of the wall to suit a variety of needs.

Dimensions: 4.55" W X 4.55" L X 1.75" D

Cable Opening: W 2.975" X H 1.375"
Color: White



**28-LV2RP
Dual Gang Cable
Distribution Mounting
Bracket**

Dual gang low voltage bulk cable mounting bracket designed for easy installation. Can be installed quickly using a 4.5" hole saw in 1/4" to 1 1/2" dry wall. Can also be used with our 28 series designer style wall plates.

Dimensions:
5 3/8" W x 5 1/4"H x 2 1/8" D
Total Internal Depth: 2"

Measured from the back of flange
Color: White



**28-LV1RP
Single Gang Cable Distribution
Mounting Bracket**

Single gang low voltage bulk cable mounting bracket designed for easy installation. Can be installed quickly using a 3.5" hole saw in 1/4" to 1 1/2" dry wall. Can also be used with our 28 series designer style wall plates.

Dimensions:
3.8" W x 5.6"H x 2.0" D
Total Internal Depth: 1 7/8" Measured from the back of flange

Color: White



**A/V WIRE DISTRIBUTION
SINGLE GANG WALL
PLATE**

Angled exit wall plate allows for inwall cables to be routed downwards

Hole Dimensions: 1.44" X .35"
28-181-IVIvory
28-181-WHWhite

CALRAD

70 Series - Telephone Accessories

**70-558 SINGLE GANG
70-559 DUAL GANG
EZ MOUNT PLATE**
Comes with two mounting screws.



70-559

**70-553A
FLUSH MOUNT WALL
BRACKET**

Bracket with bendable tabs for a standard size telephone wall plate. Standard wall opening.



**ROUND MODULAR
WALL JACK**

For new construction or conversion to modular instruments. 4-wire screw terminals.

70-411.....Ivory
70-411-W.....White



**SURFACE JACK ASSEMBLY,
STD 4-WIRE**

Replacement jack with modular jack and color-coded lugs. Complete with connector block.

70-4024-Wire, Ivory
70-402-W4-Wire, White
70-4136-Wire, Ivory
70-413-W6-Wire, White
70-4148-Wire, Ivory
70-414-W8-Wire, White



**FLUSH MOUNT PLASTIC
WALL BRACKET**

Single or Double gang flush mount bracket with adjustable locking mounting tabs.

70-556-P Single Gang
70-557-P Double Gang

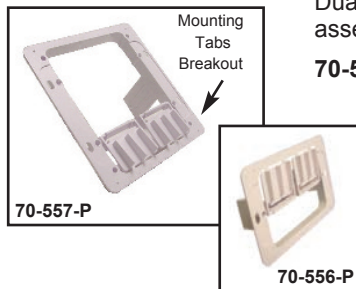

70-557-P

70-556-P

**MODULAR SURFACE JACK
ASSEMBLIES**

Dual surface mount modular jack assemblies. Color: Ivory

70-564 Dual 4-conductor, 6-position



**70-568 FLUSH MOUNT
PLASTIC WALL BRACKET**

Single gang, plastic flush mount bracket with adjustable/locking mounting tabs. Color is Black

70-569 Dual Version

Double gang version provides a large open area behind the wall plate for volume controls and other A/V products to mount in. Color is Black.



70-568



BOTTOM
CABLE PORTS



70-480

**WEATHER RESISTANT
SERVICE ENCLOSURE, UTILITY BOX**

This box is perfect for telephone and CATV cable entry point distribution or other cable management needs. Provides a secure and protected environment for all types of electronic devices. 2 piece construction with removable lid. Foam dielectric wire grommets for easy exterior wire passage, provides a sealed closure around cables, keeping out moisture and pests. Construction: high density polyethylene plastic, padlocked eye for added security, Color is light grey. Size: 10½"(H) X 4"(D) X 6¾"(W).

**70-521
WALL STUD TELEPHONE
TERMINAL BLOCK**

For new construction. Attaches to Wall stud. Color: Ivory.

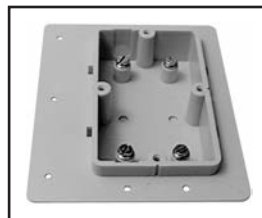

70 Series - Telephone Accessories

MODULAR "T" ADAPTER

Converts single modular jack into two modular jacks.

- 70-405.....4-Wire to 4 & 4 Std, Ivory
- 70-405-W.....4-Wire to 4 & 4 Std, White
- 70-424. Female 8-Wire to 4 & 4 Male, Ivory
- 70-425..... 6-Wire to 6 & 6 Male, Ivory
- 70-423.....8 wire, Ivory

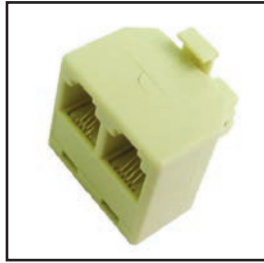

70-491

SECURITY VOICE BOX MODULAR WALL JACK

8-Pin Female modular voice box connector. For alarm reporting devices, with 4 shorting bars.
Color: Ivory.



70-489

TWO LINE SPLITTER

Contains one six-position, four conductor modular plug, and two six-position, two conductor modular jacks. It is used to split two lines from a single modular jack to two individual jacks. Color: Ivory.



70-493

5-WAY "T" CONNECTOR

Modular line cord with multiple phone "T" connectors. 1 Male to 5 modular Females, 4- conductor,
Cable Length = 14 ft.
Color: Ivory.



70-417

THREE-WAY "T" ADAPTER

Three way "T" adapter. 3 phone devices to same line. Color: Ivory.



MODULAR "T" CONNECTORS

(1) modular Female line cord type to
(2) modular Females for connecting
line cords. Color: Ivory.

70-494 4-Wire



70-539

THREE-WAY TEE

Three way "T" adapter for two lines.
Has jacks for line 1&2, and a jack that
combines line 1&2. Color: Ivory.

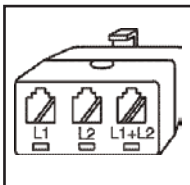

MODULAR

CORD COUPLERS

Allows two modular line cords to be
connected together.

- 70-498handset coupler, Ivory
- 70-408 4-wire for **voice**, Ivory
- 70-408-W. 4-wire for **voice**, White
- 70-407 6-wire for **voice**, Ivory
- 70-407-D6-wire for **data**, Ivory
- 70-532 8-wire for **voice**, Ivory
- 70-532-D8-wire for **data**, Ivory



70-554

HANDSET WIRE DETANGLER

Connects to handset for tangle-free
cord use. Overall length 2.25".
Color: White.



CALRAD

70 Series - Telephone Accessories

70-650

DSL SINGLE LINE MICRO FILTER

Provides uninterrupted DSL service and crystal clear conversations. Sharing a DSL connection with analog telephones may cause interference. 2 Wire DSL filters eliminate all interference between DSL line and analog telephone lines. The result is clear, clean lines for your telephones, fax machines, answering machines, caller ID and analog modems. All 2 Wire DSL filters also ensure that telephones never cause the DSL modem to adjust to the changing conditions of your DSL connection (Called retraining), which could hinder your internet access speeds. FCC approved. Male to Female RJ11. Overall length of 7". Color is off-white.



70-651

DSL LINE SPLITTER WITH SURGE PROTECTION AND DUAL MICRO FILTERS

Device splits the line to a DSL modem connectin and a analog telephone connection. Separate RJ11 female line, telephone and modem jacks. Comes with 2 mounting screws. Size: 3"L x 2.4"W x 1.09"H. Color is off-white.



70-512

INDOOR/ OUTDOOR EXTENSION TELEPHONE RINGER

An alternate to a second phone, weatherproof ABS plastic casing. Built-in modular jack for easy installation. Loud mechanical ring. Color: Ivory.



70-513

TELEPHONE LINE AND HANDSET TESTER

For testing line continuity and handset operation. Uses 9V battery (not included). Color :White.



80-566

MINIATURE TELEPHONE PICK-UP COIL

Suction cup type, attaches to phone permitting both ends of a telephone conversation to be recorded with no wiring necessary. Has 3.5mm miniature plug.



70-392 "JELLYBEAN"-STYLE TELEPHONE & ALARM INTERCONNECTS

Also known as maggots, Chiclets, beans, B-wire connectors. By using wire penetrating teeth you don't have to strip off the insulation, making it easy to splice together several wires. High-impact polycarbonate housing with thick .355mm phosphor bronze contacts. For use with 22-26 awg. wires.

70-392-25..... 25 Pcs.
70-392-100.....100 Pcs.
70-392-1000.....1000 Pcs.



70-392J "JELLYBEAN"-STYLE TELEPHONE & ALARM INTERCONNECTS

Gel filled type jellybean connectors also known as maggots, Chiclets, beans, B-wire connectors. By using wire penetrating teeth you don't have to strip off the insulation, making it easy to splice together several wires. High-impact polycarbonate housing with thick .355mm phosphor bronze contacts. For use with 22-26 awg. wires.

70-392J-25.....25 Pcs.
70-392J-100.....100 Pcs.
70-392J-1000.....1000 Pcs.



UG GEL-FILLED CONNECTOR

70-394-25.....Red, 3 port, 25 Pcs
70-394-100.....Red,3 port, 100 Pcs
70-394-1000...Red, 3 port, 1000 Pcs
70-394-YL-25..Yellow ,3 port,25 Pcs
70-394-YL-100..Yellow,3 port,100 Pcs
70-394-YL-1000.Yellow,3 port, 1K Pcs
70-395-25.....Yellow, 2 port, 25 Pcs
70-395-100...Yellow, 2 port,100 Pcs
Allows direct bridging onto existing cable conductor without service interruption. Water displacing jelly is used to minimize moisture penetration that could corrode the wiring. Available in two or three port versions. Works with 19-26 awg. wire. Packaged in 25 or 100 piece quantities.



70-393 UB GEL-FILLED CONNECTOR

Permits tapping directly into existing cable conductor without service interruption. Position and pre-crimp feature prevents conductor from slipping prior to final crimp. Water displacing jelly is used to minimize moisture penetration that could corrode the wiring. Works with 19-26 awg. wire. Packaged in 25 or 100 piece quantities.

70-393-25.....25 pcs
70-393-100..... 100 pcs.
70-393-1000..... 1000 pcs.



CALRAD

70 Series - Telephone Accessories

MODULAR PLUGS

Modular plugs to use on end of flat or round modular cable.

- 70-495 Handset Type (10 pkg.)
- 70-496 RJ11 Line Cord Type (10 pkg.)
- 70-496R RJ11 4-pin for round cable
- 70-496R-UL RJ11 4-pin, round stranded, UL app.
- 70-497 RJ45 8-pin Type (5 pkg.)
- 70-497R RJ45 8-cond, round
- 70-499 RJ12 6-pin Type (10 pkg.)
- 70-499R RJ12 6-pin, round stranded, UL app.
- 70-499RS-UL RJ12 6-pin, round solid, UL app.
- 70-514R 10 conductor for round cable
- 72-497R-25 RJ45 8-pin for CAT 5e (25 pkg.)
- 72-497R-100 RJ45 8-pin for CAT 5e (100 pkg.)
- 72-498R-25 RJ45 8-pin for CAT 6 (25 pkg.)
- 72-498R-100 RJ45 8-pin for CAT 6 (100 pkg.)

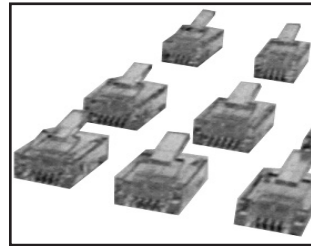

R = Round stranded
RS = Round Solid



Cable Opening



70-505 (623D4)
Modular line cord Female chassis jack. 6-position, 4 wires and lugs. For use in phone base.

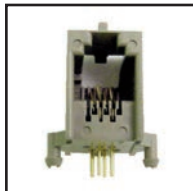

70-508 (616PC)
Modular handset chassis jack. 4-position, 4-pin, PC mount. For use in phone base.

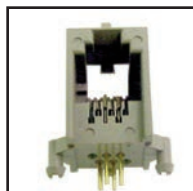

70-509 (623PC)
Modular line cord chassis jack. 6-position, 4-pin, PC mount. Use in phone base.

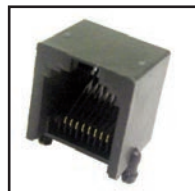

70-510
Modular Female chassis jack. 8-position, 8-pin, PC mount.



70-511
Modular Female chassis jack. 8-position, 8 wires and lugs. For 8 conductor cable equipment.

EXTENSION CORD WITH DUPLEX JACK

Modular plug to double jack for two phone devices.
70-443 14 ft.
70-444 25 ft.

BOTH IVORY COLOR



MODULAR TELEPHONE EXTENSION CORD

Can be used to extend a single pre-existing modular jack and permit connection of one telephone.
70-415 25 ft., Ivory
70-415-W 25 ft., White
70-419 14 ft., Ivory
70-419-W 14 ft., White



TELEPHONE CABLE CRIMPING TOOLS

Crimping tools for installation of line cord plugs on modular cables. Also strips outer covers.

- 70-550 8-wire
- 70-551 4 & 6-wire

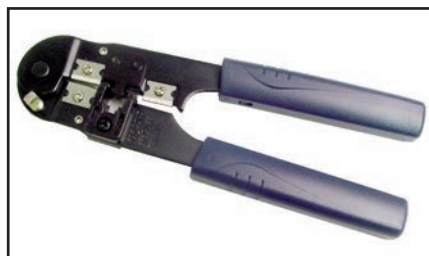

TELEPHONE CABLE CRIMPING TOOLS

Crimping tools for installation of line cord plugs on modular cables. Also strips outer covers.

- 70-516 4-wire handset & line (plastic)



CALRAD

70 Series - Telephone Accessories/Keystone Inserts

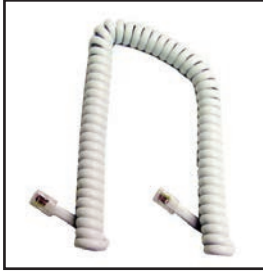

MODULAR HANDSET CORDS

Coil style handset cable with modular plugs at each end.

6' LONG

70-445	Ivory
70-446	White
70-447	Black
70-448	Ash
70-449	Brown

25' LONG

70-406	White
70-460	Beige
70-461	Black
70-465	Ivory
70-466	Ash
70-467	Silver
70-585	Grey

12' LONG

70-450	White
70-451	Beige
70-452	Black
70-453	Ivory
70-454	Ash

50' LONG

70-406-50	White
70-462-50	Brown
70-465-50	Ivory



FLAT MODULAR WIRE

28 gauge wire.

70-540*	50 ft., 4-Cond, Black, Ivory, Silver, White
70-541-100*	100 ft., 4-Cond, Black, Ivory, Silver, White
70-541-BK-1000	1000 ft., 4-Cond, Black
70-541-IV-1000	1000 ft., 4-Cond, Ivory
70-541-SL-1000	1000 ft., 4-Cond, Silver
70-541-W-1000	1000 ft., 4-Cond, White
70-544-IV-100	100 ft., 6-Cond, Ivory
70-544-IV-1000	1000 ft., 6-Cond, Ivory
70-544-SL-100	100 ft., 6-Cond, Silver
70-544-SL-1000	1000 ft., 6-Cond, Silver
70-547-IV-100	100 ft., 8-Cond, Ivory
70-547-IV-1000	1000 ft., 8-Cond, Ivory
70-547-SL-100	100 ft., 8-Cond, Silver
70-547-SL-1000	1000 ft., 8-Cond, Silver

*Specify color when ordering.



70-540, 541
CABLES

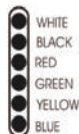

70-544
CABLES



70-547
CABLES

STRAIGHT MODULAR LINE CORDS

Modular plugs on both ends.
Flat cable.

70-416-8	8 inch, 4-Wire
70-416*	7 ft., 4-Wire
*Black, Ivory, Silver, White	
70-429*	14 ft., 4-Wire
*Black, Ivory, Silver, White	
70-397*	25 ft., 4-Wire
*Black, Ivory, Silver, White	
70-433	7 ft., 6-Wire, Silver
70-434	14 ft., 6-Wire, Silver
70-434-IV	14 ft., 6-Wire, Ivory
70-435	25 ft., 6-Wire, Silver
70-440	7 ft., 8-Wire, Silver
70-441	14 ft., 8-Wire, Silver
70-442	25 ft., 8-wire, Silver



*Specify color when ordering.

STRAIGHT MODULAR LINE CORDS

Modular plug at one end and
spade lugs on other end. Flat
cable.

70-418-IV	7 ft., 4-Wire, Ivory
70-428-IV	14 ft., 4-Wire, Ivory
70-396	25 ft., 4-Wire, Silver
70-430	7 ft., 6-Wire, Silver
70-431	14 ft., 6-Wire, Silver
70-432	25 ft., 6-Wire, Silver



72-350 KEYSTONE 2.1mm DC POWER JACK TO SCREW TERMINALS

Labeled (+, -) screw terminals.

Accepts up to 18 Awg
wire. Overall depth 1.4".

Color: BLACK



72-100T KEYSTONE 4 POSITION FEMALE TELEPHONE JACK TO SCREW TERMINALS

RJ11, 4 pin Female JACK.

Accepts up to 18 Awg wire.

Color: White



72 - Series Network Products

keystone audio/video
and data keystone
accessories

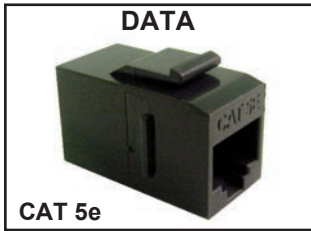

CAT 5e

72-305-E
8 POSITION FEMALE TO FEMALE KEYSTONE FEED-THRU JACK
CAT5e RJ45 Female to Female feed-thru keystone insert.
Color: Black.



72-306
6 POSITION FEMALE TO FEMALE KEYSTONE FEEDTHRU JACK
RJ12, 6 pin Female to Female feed-thru keystone insert.
Color is Black



6-POSITION UL KEYSTONE MODULAR JACK
IDC type meets level 3 & 4 requirements. 30 microns gold plated contacts and ABS material UL94/A-O. Suitable for 22-26 AWG wire. Will work as a 4 position jack.
72-100-AL.....Almond
72-100-BK..... Black
72-100-IV..... Ivory
72-100-WH..... White

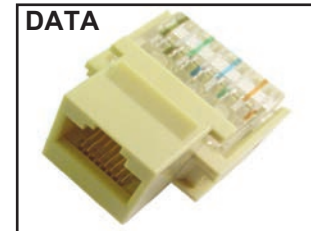

8-POSITION UL KEYSTONE MODULAR JACK
IDC type meets level 3 & 4 requirements. 30 microns gold plated contacts and ABS material UL94/A-O. Suitable for 22-26 AWG wire.
72-101-BK..... Black
72-101-IV..... Ivory
72-101-WH..... White



UL 350MHz, RJ45 ENHANCED 90° KEYSTONE JACK
Gold plated 50 microns.
72-102-AL-E90.....Almond
72-102-BK-E90..... Black
72-102-BU-E90..... Blue
72-102-GN-E90..... Green
72-102-IV-E90..... Ivory
72-102-OR-E90..... Orange
72-102-RD-E90..... Red
72-102-WH-E90..... White
72-102-YL-E90..... Yellow

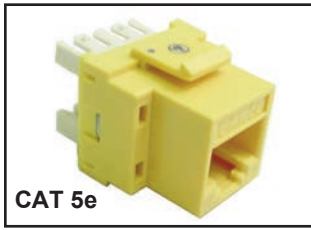

UL 350MHz, RJ45 ENHANCED KEYSTONE JACK
Gold plated 50 microns.
72-102-AL-E.....Almond
72-102-BK-E..... Black
72-102-BU-E..... Blue
72-102-GN-E..... Green
72-102-IV-E..... Ivory
72-102-OR-E..... Orange
72-102-RD-E..... Red
72-102-WH-E..... White
72-102-YL-E..... Yellow

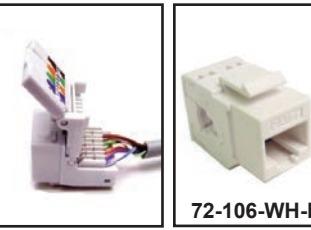

UL 350MHz, RJ45 ENHANCED TOOLESS KEYSTONE JACK
Secure self-terminating IDC mechanism allows for tool free installation Gold plated 50 microns.
72-103-AL-E.....Almond
72-103-BK-E.....Black
72-103-BU-E.....Blue
72-103-GN-E.....Green
72-103-IV-E.....Ivory
72-103-OR-E.....Orange
72-103-RD-E.....Red
72-103-WH-E.....White
72-103-YL-E.....Yellow
72-106-BK-E.....(Black) Narrow version
72-106-WH-E.....(White) Narrow version

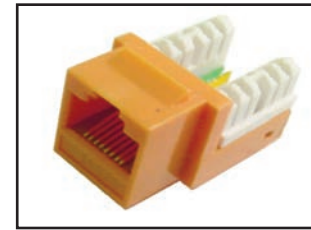

UL 1GHz RJ45 BROADBAND 90° CAT 6 KEYSTONE JACK
Gold plated 50 microns
72-400-AL.....Almond
72-400-BK.....Black
72-400-BU.....Blue
72-400-GN.....Green
72-400-IV.....Ivory
72-400-OR.....Orange
72-400-RD.....Red
72-400-WH.....White
72-400-YL.....Yellow

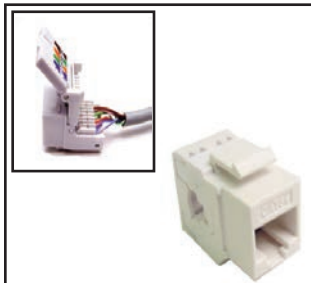

UL 1GHz RJ45 BROADBAND CAT 6 TOOLESS, KEYSTONE JACK
Secure self-terminating IDC mechanism allows for tool free installation. Gold plated 50 microns
72-401-WH.....White

RCA AUDIO/VIDEO FEMALE TO FEMALE RECESSED KEYSTONE INSERT

Recessed RCA Female to Female feed-thru jack. Flush-faced colored insert provides for easy identification. Comes with either Gold or Nickel plated connectors.
Please specify color and style when ordering

Nickel Version
72-308-BK..... Black
72-308-BU..... Blue
72-308-GN..... Green
72-308-IV..... Ivory
72-308-OR..... Orange
72-308-RD..... Red
72-308-WH..... White
72-308-YL..... Yellow

Gold Version
72-308G-BK..... Black, Gold
72-308G-BU..... Blue, Gold
72-308G-GN..... Green, Gold
72-308G-IV..... Ivory, Gold
72-308G-OR..... Orange, Gold
72-308G-RD..... Red, Gold
72-308G-WH..... White, Gold
72-308G-YL..... Yellow, Gold

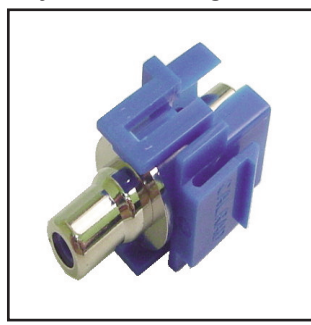

RGB+VIDEO RCA KEYSTONE INSERT
RCA Female to Female jacks with colored inserts of Blue, Green, Ivory, Red, White or Yellow, Nickel plated. Specify color when ordering.
72-300-BK.....Black
72-300-BU..... Blue
72-300-GN..... Green
72-300-IV..... Ivory
72-300-OR.....Orange
72-300-RD.....Red
72-300-WH..... White
72-300-YL..... Yellow
Gold Version available example order as " 72-300G-COLOR

CALRAD

72 Series - Keystone Inserts

SVHS VIDEO FEMALE TO FEMALE RECESSED FEED-THRU KEYSTONE INSERT

Recessed Female to Female mini din jack, in 4, 6 or 8 pin configurations. Colored insert snaps into keystone flush-faced and provides for easy identification. Comes in either **Gold** or **Nickel** plated connector. Available in black, blue, green, ivory, orange, purple, red, white, or yellow. Please specify color and style when ordering.

4 Pin Version Nickel Version

72-304-BK.....	Black
72-304-BU.....	Blue
72-304-GN.....	Green
72-304-IV.....	Ivory
72-304-OR.....	Orange
72-304-PU.....	Purple
72-304-RD.....	Red
72-304-WH.....	White
72-304-YL.....	Yellow

4 Pin Version Gold Version

72-304G-BK.....	Black, Gold
72-304G-BU.....	Blue, Gold
72-304G-GN.....	Green, Gold
72-304G-IV.....	Ivory, Gold
72-304G-OR.....	Orange, Gold
72-304G-PU.....	Purple, Gold
72-304G-RD.....	Red, Gold
72-304G-WH.....	White, Gold
72-304G-YL.....	Yellow, Gold

6 Pin Version Nickel Only

72-304-6-BK.....	Black
72-304-6-BU.....	Blue
72-304-6-GN.....	Green
72-304-6-IV.....	Ivory
72-304-6-OR.....	Orange
72-304-6-PU.....	Purple
72-304-6-RD.....	Red
72-304-6-WH.....	White
72-304-6-YL.....	Yellow

Gold Version available just order as sample" 72-304G-6-COLOR

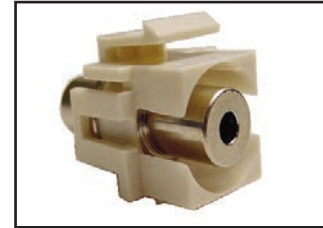

72-310 3.5mm STEREO FEMALE TO FEMALE RECESSED INSERT

Recessed 3.5mm stereo Female to Female keystone feed-thru jack. Colored insert snaps into keystone flush-faced and provides for easy identification. Nickel plated connector.

72-310-BK.....	Black
72-310-BU.....	Blue
72-310-GN.....	Green
72-310-IV.....	Ivory
72-310-RD.....	Red
72-310-WH.....	White

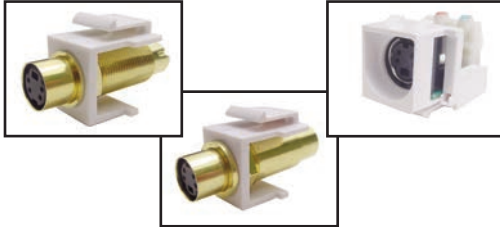

SVHS KEYSTONE CONNECTORS

72-311G..... Male to Female Feedthru
72-312G..... Female to Female Feedthru
72-314G..... Recessed Female to Punchdown
New 4 pin SVHS Keystone connectors. Choose from either feedthru or connector styles. Available in feedthru configurations of Male to Female or Female to Female. Connector styles come with solder cups or terminals. Gold plated with white keystone snap-in. Works in conjunction with Calrad p/n 72-233 four and six port insert plates.



50 OHM BNC FEMALE TO FEMALE INSERT

3/8" "D" bulkhead 50 Ohm BNC jack mounted in a keystone insert.

72-210-AL.....	Almond
72-210-IV.....	Ivory
72-210-WH.....	White

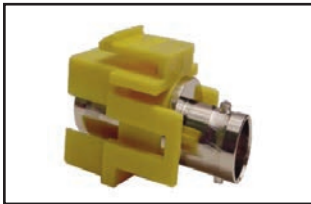

75 OHM BNC FEMALE TO FEMALE RECESSED INSERT

Recessed 75 ohm BNC Female to Female feed-thru jack. Colored insert snaps into keystone flush-faced and provides for easy identification. Nickel plated connector.

72-307-BK.....	Black
72-307-BU.....	Blue
72-307-GN.....	Green
72-307-IV.....	Ivory
72-307-RD.....	Red
72-307-WH.....	White
72-307-YL.....	Yellow



'F' CONNECTOR FEMALE TO FEMALE INSERT

"F-81" RF KEYSTONE FEED-THRU Non-Recessed 1/2" bulkhead standard F-81 jack mounted in a keystone insert.

72-211-IV.....	Ivory
72-211-WH.....	White
72-211-2GHZ.....	White
72-211-3GHZ.....	White



BANANA JACK FEMALE TO FEMALE RECESSED INSERT

Isolated banana jack feed-thru in a recessed, flush-faced keystone insert. Provides a smooth cosmetic look and colored insert allows for easy channel identification.

72-330-BK Black
72-330-RD Red

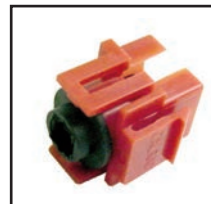

TOSLINK FEMALE TO FEMALE RECESSED INSERT

Toslink Female to Female feed-thru insert. Colored flush-faced insert allows for smooth appearance and easy identification. Available in Black, Blue, Green, Ivory, Red or White. Please specify color when ordering.

72-320-BK.....	Black
72-320-BU.....	Blue
72-320-GN.....	Green
72-320-IV.....	Ivory
72-320-RD.....	Red
72-320-WH.....	White
72-320-YL.....	Yellow



72-320 PANEL MOUNT TOSLINK FEMALE TO FEMALE FEED-THRU

Toslink Female to Female panel mount feed-thru. Comes with mounting hardware or can be used with the 72-205 colored keystone insert.

72 Series - Keystone Inserts, Network Products



72-125KS-2



72-125K



72-126K

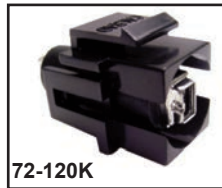

72-120K

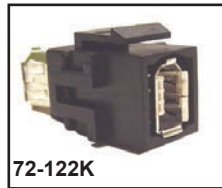

72-122K

Bi-directional passive UTP Cat5e, Cat6 USB adapters are perfect for low power low-speed USB devices like touch screens, printers, RF dongles, media storage devices. Easy to install cable using a cable stripper, slotted screw driver. Mounts in a standard keystone wall plate or can be used as a stand alone solution. Supports 1.1 and 2.0 devices, some 2.0 devices will work up to the 65 ft. and others will not and will be limited to 1.1 specifications. Use standard type 'A' to 'A' cables for connecting the transmitter and receiver, the cables should be as short as possible 1-3', if you use 6' cables on each side then they should be considered in the overall distance calculation. Terminal Set Screw: Slotted Head, Exceeds Wire Size: 20-28 gauge Solid UTP cable, use (Cat5, Cat5e, Cat6), Works with USB type 1.1, 2.0 devices, Insulation resistance: 500M ohms or more @ 500V, Insertion Loss: <.5db, Connector Type: 4 Pin Gold Female USB Type A Jack. Distance between connectors 65 ft. maximum (Based on Solid UTP Cable), Color: Black, Mounting Depth 1.93".

TYPE "A" USB FEMALE TO FEMALE & SOLDERLESS KEYSTONE INSERTS

72-125K USB type A feed-thru
72-125K-W USB type A feed-thru color white
72-125K-S solderless Type "A" USB keystone insert in either solderless or Female feed-thru styles. Solderless version has individual "U" shaped screw terminals for a solid secure wiring termination.

TYPE "B" USB FEMALE TO FEMALE & SOLDERLESS KEYSTONE INSERTS

72-126K feed-thru
72-126K-S solderless Type "B" USB keystone insert in either solderless or Female feed-thru styles. Solderless version has individual "U" shaped screw terminals for a solid secure wiring termination.

4 PIN RECESSED FIREWIRE FEMALE TO FEMALE & SOLDERLESS KEYSTONE INSERTS

72-120K feed-thru
72-120K-S solderless 4 pin firewire keystone insert in either solderless or Female feed-thru styles. Solderless version has individual "U" shaped screw terminals for a solid secure wiring termination.

6 PIN FIREWIRE FEMALE TO FEMALE & SOLDERLESS KEYSTONE INSERTS

72-122K feed-thru
72-122K-S solderless 6 pin firewire keystone insert in either solderless or Female feed-thru styles. Solderless version has individual "U" shaped screw terminals for a solid secure wiring termination.



75-696K-S
 35-498K-S
 30-308K-S



30-288 WASHERS

75-696K-S BNC
30-308-K-S RCA
35-498K-S SVHS



SOLDERLESS KEYSTONE & CHASSIS MOUNT RCA, BNC AND SVHS JACKS

Our new patent pending connectors provide a solderless and connectorless backside termination solution. These connectors can mount in a 1/2" hole or be assembled into any of Calrad's blank keystone inserts or chassis panels with colored plastic washers (part# 30-288-color) in black, blue, green, ivory, red, orange, violet or white). The individual "U" shaped screw terminals gives a solid and secure wiring termination. Small slotted screws on the back of the connector are used to tighten the cable connections. Each terminal is clearly labeled for easy wiring connection. These connectors work with Calrad's 55-770G miniature S-Video cable, 55-868B SVHS + audio cable or 55-897B miniature stereo audio cable. **To be used as keystone inserts, you must use Calrad 72-205-COLORED inserts. See Below**

RECESSED KEYSTONE BLANK INSERTS

Blank recessed keystone insert, Available in Black, Blue, Green, Ivory, Orange, Purple, Red, White and Yellow.

- 72-205-BK**.....Black
- 72-205-BU**.....Blue
- 72-205-GN**.....Green
- 72-205-IV**.....Ivory
- 72-205-OR**.....Orange
- 72-205-PU**.....Purple
- 72-205-RD**.....Red
- 72-205-WH**.....White
- 72-205-YL**.....Yellow



RJ45 SNAGLESS RUBBER BOOTS

Available in Black, Blue, Ivory, Orange, Red, White, Yellow, Green or Grey. Used with round cable.
72-104-BK Black
72-104-BU Blue
72-104-GN Green
72-104-GY Grey
72-104-IV Ivory
72-104-OR Orange
72-104-RD Red
72-104-WH White
72-104-YL yellow



RJ45 MODULAR PLUG for CAT5e and CAT6

Crimp style connector for use with twisted pair data cables. Gold plated 50 microns of gold.

- CAT5e**
- 72-497R-25** pack of 25
- 72-497R-100** pack of 100
- CAT6**
- 72-498R-25** pack of 25
- 72-498R-100** pack of 100



CALRAD

72 Series - Network Products



FIELD INSTALLABLE 2-PIECE SNAP-ON RJ45 SNAGLESS BOOTS

- 72-105-BK Black
- 72-105-BU Blue
- 72-105-IV Ivory
- 72-105-OR Orange
- 72-105-RD Red
- 72-105-WH White
- 72-105-YL Yellow



KEYSTONE BLANK CONNECTOR INSERT

Blank insert with 3/8" hole. For use with Calrad connectors and Keystone cavity wall plates.

- 72-217-IV Ivory
- 72-217-WH White

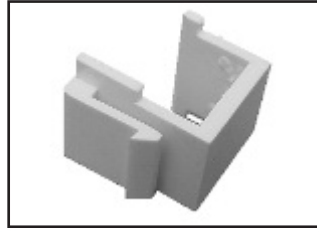

KEYSTONE BLANK INSERT

Blank insert for use with Calrad Keystone cavity wall plates.

- 72-213-AL Almond
- 72-213-IV Ivory
- 72-213-WH White



CAT 5e

72-109 CAT-5e INLINE COUPLER

Connect 2 CAT-5, CAT-5e cables together. Bandwidth up to 500Mbps. Meets FCC part 68. Contacts are plated with 50 microns of gold over 100 microns of nickel on phosphor. Size: 1.02"W x .98"H x 1.88"D.. Color is white.

72-109-CAT6 for Cat-6 inline coupler version



72-230 KEYSTONE PLASTIC WALL PLATES

Includes mounting hardware. Available in White, Almond and Ivory

- 72-230-1 1 port, White
- 72-230-2 2 ports, White
- 72-230-3 3 ports, White
- 72-230-4 4 ports, White
- 72-230-6 6 ports, White
- 72-230-1-AL 1 port, Almond
- 72-230-2-AL 2 ports, Almond
- 72-230-3-AL 3 ports, Almond
- 72-230-4-AL 4 ports, Almond
- 72-230-6-AL 6 ports, Almond
- 72-230-1-IV 1 port, Ivory
- 72-230-2-IV 2 ports, Ivory
- 72-230-3-IV 3 ports, Ivory
- 72-230-4-IV 4 ports, Ivory
- 72-230-6-IV 6 ports, Ivory



72-231 ANGLED CAVITY KEYSTONE WALL PLATES

- 72-231-1 1 port, White
- 72-231-2 2 ports, White
- 72-231-3 3 ports, White
- 72-231-4 4 ports, White

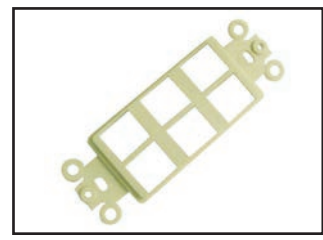

DESIGNER STYLE CAT-5 KEYSTONE WALL PLATE INSERTS

- Includes mounting screws.
- 72-233-1 1 port, White
 - 72-233-2 2 ports, White
 - 72-233-3 3 ports, White
 - 72-233-4 4 ports, White
 - 72-233-6 6 ports, White
 - 72-233-1-IV 1 port, Ivory
 - 72-233-2-IV 2 ports, Ivory
 - 72-233-3-IV 3 ports, Ivory
 - 72-233-4-IV 4 ports, Ivory
 - 72-233-6-IV 6 ports, Ivory



CAT 5e

72-108-WH DUPLEX ENHANCED SURFACE MOUNT JACK
Up to 350MHz PCB surface mount jack with 110 IDC, allows for quick and easy installation. UL certified to meet EIA/TIA 568A or B, TSB 40A specifications. 2 RJ45 jacks. Includes mounting hardware.



CAT 5e

72-107-WH SINGLE ENHANCED SURFACE MOUNT JACK
Up to 350MHz PCB surface mount jack with 110 IDC, allows for quick and easy installation. UL certified to meet EIA/TIA 568A or B, TSB 40A specifications. 1 RJ45 jack. Includes mounting hardware. Color is white

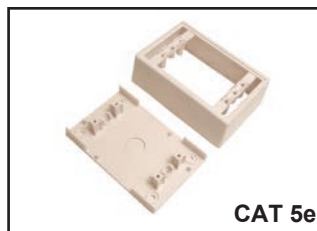

CAT 5e

72-236-WH PLASTIC CAT-5, CAT-5e BACK BOX
For use with Calrad 72-229-1, 72-229-2 duplex style Keystone wall plates. Includes mounting hardware. Color is white



72-248 LAN & VOICE CABLE TESTER

Tests for RJ45 modular connection with 258A, 568A & B, 356A wiring and 10 baseT & BNC coaxial. Includes 2 adapters for USOC RJ12 and RJ11 test usage. Performs test of cable continuity, miss wiring and polarization by the color of the L.E.D. indicators. Detachable remote unit for installed cabling. Powered using a 9V battery. Includes black ballistic nylon carrying case.

CALRAD

72 Series - Network Products



72-241
7.3" MODULAR CRIMP TOOL

Cuts, strips, and crimps two types of plugs 6P & 8P in one. For crimping: 8P8C/RJ45, 6P6C/RJ12, 6P4C/RJ11 and 6P2C plugs. Steel body with easy grip plastic handles.

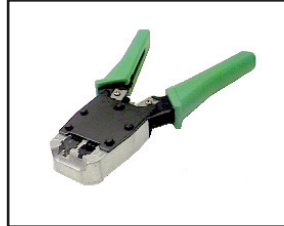

72-242
7.6" PRO MODULAR CRIMP TOOL

For crimping 6P-RJ11 / RJ12 & 8P-RJ45, suitable for both stranded and solid wire. Provides precision crimping, cutting and stripping wire in one operation. Ratchet style mechanism.



72-240
MULTI-PURPOSE MODULAR CRIMP TOOL

RJ45 crimping tool cuts, strips and crimps quickly and easily. For RJ45 ethernet and RJ11 plugs. Provides repeatability and reliability of crimp. High impact plastic construction. Compact size, easy to handle.



70-550
TELEPHONE CABLE CRIMPING TOOL

For crimping RJ45 plugs. Crimping tools for installation of line cord plugs on modular cables. Also strips outer covers.



72-234 ADJUSTABLE IMPACT PUNCH DOWN TOOL

Provides consistent action for seating wire into terminal blocks. Adjustable impact pressure control. The back of the handle is a storage compartment for 1 spare blade. For use with Calrad 72-245, 72-246, 72-247 blades.



72-244
IMPACT PUNCH DOWN TOOL

Provides consistent action for seating wire into terminal blocks. For use with Calrad 72-245, 72-246, 72-247 blades.



72-239
PLASTIC PUNCH TOOL

Inexpensive disposable punch down tool with cable stripping blade for outer PVC jacket. Suitable for small jobs. Works with 5-6mm O.D. UTP/STP cable. Terminates conductors on 110 blocks.



PUNCH DOWN BLADES FOR 72-234 AND 72-244

PUNCH DOWN TOOLS
72-245 66 punch down blade
72-246 110/88 punch down blade
72-247 66, 110/88 punch down blade



72-110
350MHz CAT-5E, RJ45 SNAGLESS CABLES

UL high performance, stranded hi-flex conductors for superior flexibility. Color cable and boot. Gold plated plugs with 50 microns of plating.

BLACK
72-110-1-BK.....1 ft. Black
72-110-3-BK.....3 ft. Black
72-110-5-BK.....5 ft. Black
72-110-7-BK.....7 ft. Black
72-110-10-BK.....10 ft. Black
72-110-14-BK.....14 ft. Black
72-110-25-BK.....25 ft. Black
72-110-50-BK.....50 ft. Black
72-110-100-BK.....100 ft. Black

72-110
350MHz CAT-5E, RJ45 SNAGLESS CABLES

RED
72-110-1-RD.....1ft. Red
72-110-3-RD.....3 ft. Red
72-110-5-RD.....5 ft. Red
72-110-7-RD.....7 ft. Red
72-110-10-RD.....10 ft. Red
72-110-14-RD.....14 ft. Red
72-110-25-RD.....25 ft. Red
72-110-50-RD.....50 ft. Red
72-110-100-RD...100 ft. Red

72-110
350MHz CAT-5E, RJ45 SNAGLESS CABLES

BLUE
72-110-1-BU.....1ft. Blue
72-110-3-BU.....3ft. Blue
72-110-5-BU.....5 ft. Blue
72-110-7-BU.....7 ft. Blue
72-110-10-BU.....10 ft. Blue
72-110-14-BU.....14 ft. Blue
72-110-25-BU.....25 ft. Blue
72-110-50-BU.....50 ft. Blue
72-110-100-BU.100 ft. Blue

72-110
350MHz CAT-5E, RJ45 SNAGLESS CABLES

WHITE
72-110-1-WH.....1 ft. White
72-110-3-WH.....3 ft. White
72-110-5-WH.....5 ft. White
72-110-7-WH.....7 ft. White
72-110-10-WH.....10 ft. White
72-110-14-WH.....14 ft. White
72-110-25-WH.....25 ft. White
72-110-50-WH.....50 ft. White
72-110-100-WH.100 ft. White

72-110
350MHz CAT-5E, RJ45 SNAGLESS CABLES

GREEN
72-110-1-GN.....1ft. Green
72-110-3-GN.....3ft. Green
72-110-5-GN.....5 ft. Green
72-110-7-GN.....7 ft. Green
72-110-10-GN.....10 ft. Green
72-110-14-GN.....14 ft. Green
72-110-25-GN.....25 ft. Green
72-110-50-GN.....50 ft. Green
72-110-100-GN.100 ft. Green

72-110
350MHz CAT-5E, RJ45 SNAGLESS CABLES

YELLOW
72-110-1-YL.....1ft. Yellow
72-110-3-YL.....3 ft. Yellow
72-110-5-YL.....5 ft. Yellow
72-110-7-YL.....7 ft. Yellow
72-110-10-YL.....10 ft. Yellow
72-110-14-YL.....14 ft. Yellow
72-110-25-YL.....25 ft. Yellow
72-110-50-YL.....50 ft. Yellow
72-110-100-YL.100 ft. Yellow

72-110
350MHz CAT-5E, RJ45 SNAGLESS CABLES

GREY
72-110-1-GY.....1ft. Grey
72-110-3-GY.....3ft. Grey
72-110-5-GY.....5 ft. Grey
72-110-7-GY.....7 ft. Grey
72-110-10-GY.....10 ft. Grey
72-110-14-GY.....14 ft. Grey
72-110-25-GY.....25 ft. Grey
72-110-50-GY.....50 ft. Grey
72-110-100-GY.100 ft. Grey

CALRAD

72 series - Cat 6 Cables & Adapters



72-111
1 GHz CAT-6E, RJ45
SNAGLESS CABLES

BLACK

- 72-111-3-BK3 ft. Black
- 72-111-5-BK5 ft. Black
- 72-111-7-BK7 ft. Black
- 72-111-10-BK 10 ft. Black
- 72-111-14-BK 14 ft. Black
- 72-111-15-BK15 ft. Black
- 72-111-25-BK25 ft. Black
- 72-111-50-BK50 ft. Black
- 72-111-75-BK75 ft. Black
- 72-111-100-BK100 ft. Black

72-111
1 GHz CAT-6E, RJ45
SNAGLESS CABLES

GREY

- 72-111-3-GY3 ft. Grey
- 72-111-5-GY5 ft. Grey
- 72-111-7-GY7 ft. Grey
- 72-111-10-GY 10 ft. Grey
- 72-111-14-GY 14 ft. Grey
- 72-111-15-GY15 ft. Grey
- 72-111-25-GY25 ft. Grey
- 72-111-50-GY50 ft. Grey
- 72-111-75-GY75 ft. Grey
- 72-111-100-GY100 ft. Grey

72-111
1 GHz CAT-6E, RJ45
SNAGLESS CABLES

BLUE

- 72-111-3-BU3 ft. Blue
- 72-111-5-BU5 ft. Blue
- 72-111-7-BU7 ft. Blue
- 72-111-10-BU 10 ft. Blue
- 72-111-14-BU 14 ft. Blue
- 72-111-25-BU25 ft. Blue
- 72-111-50-BU50 ft. Blue
- 72-111-75-BU75 ft. Blue
- 72-111-100-BU100 ft. Blue

72-111
1 GHz CAT-6E, RJ45 SNAGLESS
CABLES

GREEN

- 72-111-3-GN3 ft. Green
- 72-111-5-GN5 ft. Green
- 72-111-7-GN7 ft. Green
- 72-111-10-GN10 ft. Green
- 72-111-14-GN 14 ft. Green
- 72-111-25-GN25 ft. Green
- 72-111-50-GN50 ft. Green
- 72-111-75-GN75 ft. Green
- 72-111-100-GN100 ft. Green

72-111
1 GHz CAT-6E, RJ45
SNAGLESS CABLES

WHITE

- 72-111-3-WH3 ft. White
- 72-111-5-WH5 ft. White
- 72-111-7-WH7 ft. White
- 72-111-10-WH10 ft. White
- 72-111-14-WH 14 ft. White
- 72-111-25-WH25 ft. White
- 72-111-50-WH50 ft. White
- 72-111-75-WH75 ft. White
- 72-111-100-WH100 ft. White

72-111
1 GHz CAT-6E, RJ45
SNAGLESS CABLES

YELLOW

- 72-111-3-YL3 ft. Yellow
- 72-111-5-YL5 ft. Yellow
- 72-111-7-YL7 ft. Yellow
- 72-111-10-YL 10 ft. Yellow
- 72-111-14-YL 14 ft. Yellow
- 72-111-25-YL25 ft. Yellow
- 72-111-50-YL50 ft. Yellow
- 72-111-75-YL75 ft. Yellow
- 72-111-100-YL100 ft. Yellow

72-111
1 GHz CAT-6E, RJ45
SNAGLESS CABLES

RED

- 72-111-3-RD3 ft. Red
- 72-111-5-RD5 ft. Red
- 72-111-7-RD7 ft. Red
- 72-111-10-RD 10 ft. Red
- 72-111-14-RD 14 ft. Red
- 72-111-25-RD25 ft. Red
- 72-111-50-RD50 ft. Red
- 72-111-75-RD75 ft. Red
- 72-111-100-RD100 ft. Red

**72-171, 72-172, 72-173, 72-RJ45-T,
RJ45 to Terminal Block Adapters
For Use With Video Balun
Termination and Point to Point
Cat5e, Cat6 Signal Termination**

Small Slotted
Screw Driver
Required

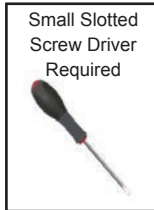

Solderless RJ45 to terminal block adapters provide a reusable connection solution resulting in a simple and convenient method of connecting products or devices with different types of signals over inexpensive UTP Cat5e, Cat 6 cable without the use of tedious RJ45 connectors or crimping tool. If you need to change or modify your installation for use with different signals, no problem simply change the wiring with a small slotted screw driver, no additional connectors are necessary. Labeled terminal blocks 1-8 positions, Accepts 22 to 24 AWG wire.

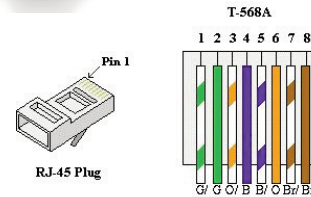
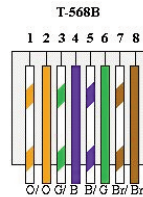
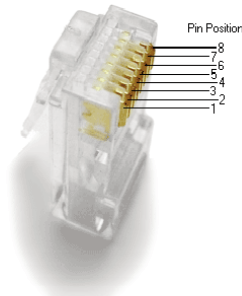

72-171
RJ45 Male to 8
Position Terminal
Block



72-172
RJ45 Male to 8 Position
Terminal Block, 6"
Pigtail Cable



72-173
RJ45 Female to 8
Position Terminal
Block, 6" Pigtail Cable

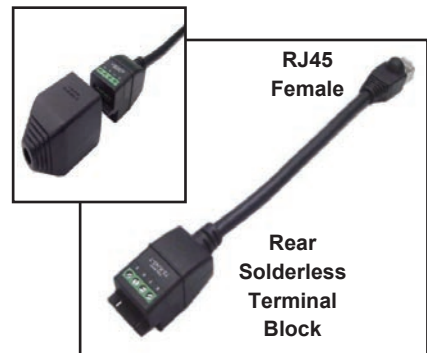

72-RJ45-T
RJ45 Male to 8 Position Terminal
Block, 6" Pigtail Cable. Includes
Rubber Strain Relief and Cable Tie

72 Series - Mini USB Cables & Adapters

INLINE USB ADAPTERS
Adapts USB configurations Type A and B and PS2 (6 pin mini din)



72-252
MALE TO MALE
TYPE "A" USB
ADAPTER



72-253
FEMALE TO
FEMALE TYPE "A"
USB ADAPTER



72-254
MALE TO MALE
TYPE "B" USB
ADAPTER



72-255
TYPE "A" MALE USB
TO TYPE "B" FEMALE
USB ADAPTER



72-256
TYPE "A" FEMALE
USB TO TYPE "B"
FEMALE USB
ADAPTER



72-193
TYPE "A" MALE USB
TO PS2 MOUSE AND
KEYBOARD
ADAPTER



72-258
TYPE "A" MALE
USB TO PS2
FEMALE USB
ADAPTER

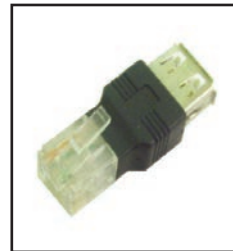

72-259
TYPE "A" FEMALE
USB TO RJ45
PLUG



72-270
CAT 5E or CAT 6
CROSSOVER ADAPTER
RJ45 Male to Female adapter
turns any standard Cat 5 or
Cat 6 ethernet patch cable
into a crossover cable.

Mini USB Adapter Cables

These mini USB 2.0 cables allow the user to interface their digital camera or other products to standard USB type A or B. Available in 4 and 5 pin configurations.

Versions Available

Mini USB 5 Pin Male to USB Type A

72-260-33 ft.

72-260-66 ft.

Mini USB 4 Pin Male to USB Type A

72-261-33 ft.

72-261-66 ft.

Mini USB 4 Pin Male to USB Type B

72-262-33 ft.

Mini USB 4 Pin Male to Mini USB 4 Pin Male

72-263-33 ft.

Mini USB 5 Pin Male to Mini USB 5 Pin Male

72-264-33 ft.

72-264-66 ft.

RS232 TO USB ADAPTER CABLE

72-UC-320

USB to DB9 Serial Adapter provides a simple connection between USB and RS-232 serial port. Designed to connect to Cellular phones, PDA's, digital cameras, modems, or ISDN terminal adapters. Over 500 kbps data transfer rate. Uses no IRQs so it is perfect if you need to connect many serial devices to your PC. USB 1.1 compliant. Pentium 233MHz or higher. Windows XP, Vista, and Windows 7 also supports Mac 10.X.



72-260



72-261



72-262



72-263



72-264



72-UC-320

72-FIR USB INTERNET MEDIA PLAYER

Allows you to access more than 25,000 free internet radio stations, 2,500 free internet TV stations and over 2,500 free internet games. No monthly fees or software to download. Simply plug the USB media player into the USB port of any PC with internet access for hours of free entertainment. Easily search for available TV or radio stations through the navigation map or built in search engine. The record function allows you to save your favorite programs on your computers hard drive.
PC ONLY DOES NOT WORK ON MAC



CALRAD

72 Series - USB Hubs, USB-PS2 Over Cat 5 Extenders



72-140

ETHERNET OVER AC

Network PC's using existing AC wiring. Transmit data rates up to 14Mbps. Easy to install and set up. Just plug the unit into an AC socket and connect the ethernet cable to the 10/100Mb ethernet port of the PC or laptop. Can not be used with power strips or UPS power supplies. PC and Mac compatible.



72-128.....16 ft.

72-128-26.....26 ft.

USB TYPE 'A' 16 ft. EXTENSION CABLE

Embedded USB transceiver cable prevents signal loss. Extends the cable length of any USB device by an additional 16 or 26 feet. Daisy chain up to an additional 4 cables for a max extension of 80ft. Male to Female USB type "A" connectors.



72-131

USB 1.1 CAT5e Extender

A simple solution for extending USB 1.1 over Cat 5e or Cat 6 cable up to 150 ft. For use with USB printers, USB scanners and USB mouse or keyboards. Dimensions: L- 2.5" X W-1.5" X D-.875".



72-132

USB OVER CAT5 EXTENDER CABLE

Extend the distance between a USB device and a host computer by up to 150 feet. It consists of 2 pieces of a local unit with USB Type A Male (host computer side) and a remote unit device side) with built-in USB Type A Female connector. Standard CAT5/5e/6 network cable (UTP or STP) is used to connect the two units together. No External power required.



72-142

4 Port USB Type 'A' 2.0 Hub with 6" Pigtail

Running out of USB Ports? Look no further. The Calrad 72-142 is a portable solution to your USB port problems. It allows for up to 4 additional USB ports and with backward compatibility it's a great and inexpensive way to expand your connect ability. Compact and portable, you can move it between systems or take it with you anywhere you need it.



40-KM01

PS2 Mouse and Keyboard over Cat5e/Cat6 Balun

A low cost solution for extending the transmission signals of the mouse and keyboard over Cat5e or Cat 6 UTP cable up to 300 feet.



72-191

(KVM) Keyboard, Video, Mouse Cable Available lengths

72-191-6.....6 ft.

72-191-10.....10 ft.

72-191-15.....15 ft.



40-UE04H

USB CAT5e Extender with 4 Port USB 1.1 Hub

Extend four USB devices up to 50 meters over CAT5/5e cable. USB 1.1 compliant. Including local and remote unit. Compact size, easy plug and play. 5Vdc power supply included.

40-UE02

USB 2.0 CAT5e Extender

USB 2.0 extender can extend 4 USB 2.0 devices up to 150 meters from the location of your computer over CAT5/5e/6 UTP cable.

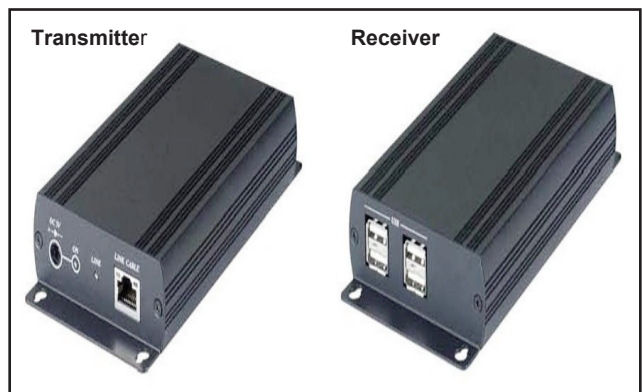

72 Series - USB, Firewire, DB9/Mouse Cables, Bulk Cat5e, 6 Wire

USB SERIAL CABLES

Universal Serial Bus 2.0 (USB 2.0) brings a new standard of speed to the USB market. These new highspeed USB cables give more versatility to computers and peripherals than ever before. USB 2.0 increases signal transmission from standard USB 1.1 topping out at 12Mb/s up to 480Mb/s for USB 2.0. The cables are completely backward compatible with standard USB ports, so there isn't any need to worry that you will not be able to use USB 2.0 cables on the standard USB products you already own.

VERSION 2.0 USB TYPE A CABLES

- 72-125-3 3 ft.
- 72-125-6 6 ft.
- 72-125-10 10 ft.
- 72-125-12 12 ft.
- 72-125-15 15 ft.

VERSION 3.0 USB TYPE A CABLES

- 72-135-3 3 ft.
- 72-135-6 6 ft.
- 72-135-15 15 ft.

VERSION 2.0 USB TYPE A/B CABLES

- 72-126-3 3 ft.
- 72-126-6 6 ft.
- 72-126-10 10 ft.
- 72-126-12 12 ft.
- 72-126-15 15 ft.



Type A Type B

FIREWIRE CABLES

This type of IEEE 1394 cable carries up to over 400MBps of bandwidth.

- 72-120-6 4-pin/4-pin, 6 ft.
- 72-120-10 4-pin/4-pin, 10 ft.
- 72-120-12 4-pin/4-pin, 12 ft.
- 72-120-15 4-pin/4-pin, 15 ft.
- 72-121-6 6-pin/4-pin, 6 ft.
- 72-121-10 6-pin/4-pin, 10 ft.
- 72-121-12 6-pin/4-pin, 12 ft.
- 72-121-15 6-pin/4-pin, 15 ft.
- 72-122-6 6-pin/6-pin, 6 ft.
- 72-122-10 6-pin/6-pin, 10 ft.
- 72-122-12 6-pin/6-pin, 12 ft.
- 72-122-15 6-pin/6-pin, 15 ft.



72-123

Firewire Adapter
6 Pin Male to 4 Pin Female

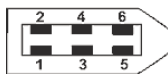

6 Pin

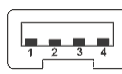

4 Pin

72-119-4 4 Pin
72-119-6 6 Pin
4 pin or 6 pin Female to Female firewire coupler.



72-124

Firewire Adapter
6 Pin Female to 4 Pin Male



72-190

SHIELDED 6 Pin MINI-DIN EXTENSION CABLE

6-pin mini din Male to Female extension cable, wired pin to pin.

- 72-190-6 6 ft.
- 72-190-10 10 ft.



72-194

SHIELDED 6 Pin MINI-DIN MALE TO MALE CABLES

6-pin mini din Male to Male cable, wired pin to pin.

- 72-194-6 6 ft.
- 72-194-10 10 ft.



DB-9/RS232

MOUSE/MONITOR MALE TO MALE CABLES

- 72-195-6 6 ft.
- 72-195-10 10 ft.

DB-9 MOUSE/MONITOR MALE TO FEMALE CABLES

- 72-196-6 6 ft.
- 72-196-10 10 ft.

Also known as RS232 cables. 9 wire 26-28 awg conductors with foil shielding. Pin to pin wiring. Rugged molded construction with long grip-textured slotted thumb screws.



72-127

USB A Male to USB A Female Extension Cables

- 72-127-6" 6 in.
- 72-127-3 3 ft.
- 72-127-6 6 ft.
- 72-127-10 10 ft.



KEYSTONE BLANK PATCH PANELS

Numbered prepunched panels with durable black finish.

- 72-226-12 12 ports
19"W x 1 3/4"H x 3/8"D
- 72-226-16 16 ports
19"W x 1 3/4"H x 3/8"D
- 72-226-24 24 ports
19"W x 3 1/2"H x 3/8"D
- 72-226-48 48 ports
19"W x 5 1/4"H x 3/8"D

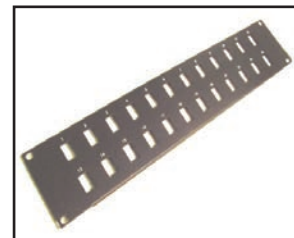

72-225 WIRE

MANAGEMENT PANEL
4 stand offs for routing cables. 1 3/4" x 1 3/4" stand off openings for cable passage. Size: 19"(W) x 1 3/4"(H) x 1 1/4"(D). Durable black finish.



72-250 (Solid)

72-250-S (Stranded)

CAT-5e CABLE 350MHz
1000' roll solid twisted pair unshielded UL/CSA, 24 AWG 4 pair, PVC jacket. UL/CSA for fast ethernet 10/100/350 Base-T. Colors available Blue, Grey and White.

72-251 (Solid)

CAT-6 CABLE

1000' pull box of solid twisted pair unshielded UL/CSA, 24 AWG 4 pair. 100Mbps. UL/CSA for fast ethernet 10/100 Base-T. PVC jacket. Colors may vary.



CAT-6

CALRAD

75 Series - t V & r f -Cat V accessories

Technical drawings and specifications are available for these products. Please ask your Calrad sales representative for details.



t Hr U t HE Wa LL BUSHINGS f Or COaX Ca BLE

Gives your installation a professional look. Flanges help to secure an protect cable, 2 pieces per package.

- 75-498 Ivory for RG59, RG6 cable, max O.D. .31" opening
- 75-498-BK Black for RG59, RG6 cable, max O.D. .31" opening
- 75-498-Q Clear for Quad RG6 cable, max O.D. .32" opening
- 75-498-D Ivory for RG59, RG6 dual feed, cable, max O.D. .62"
- 75-498-D-BK Black for RG59, RG6 dual feed, cable, max O.D. .62"



75-499 PUSH-ON 75 OHM Ba LUN Mat CHING t r a Ns f Or MEr

Convert 300 ohm antenna leads to 75 ohm Male 'F' push-on connector.



Clips with nail anchors for various cable mounting.

COaX CLIPS f Or r G 59

- 75-605-BK-25 25 per pack, Black
- 75-605-W-25 25 per pack, White
- 75-605-BK-100 .. 100 per pack, Black
- 75-605-W-100 ... 100 per pack, White

COaX CLIPS f Or r G 6

- 75-606-BK-25 25 per pack, Black
- 75-606-W-25 25 per pack, White
- 75-606-BK-100 .. 100 per pack, Black
- 75-606-W-100 ... 100 per pack, White



Clips with nail anchors for various cable mounting.

CLIPS f Or MISC. Wir E

- 75-650-BK-25-100..... Round Cable, 25 or 100 pk, Black
- 75-650-W-25-100..... Round Cable, 25 or 100 pk, White
- 75-651-W-25-100 extra Small Flat Wire, 25 or 100 pk, White
- 75-652-W-25-100 Small Flat Wire, 25 or 100 pk, White
- 75-653-W-25-100 Medium Flat Wire, 25 or 100 pk, White
- 75-654-W-25-100 Large Flat Wire, 25 or 100 pk, White
- 75-655-W-20-100 extra Large Flat Wire, 20 or 100 pk, White
- 75-656-BK-25-100..... RG-8/RG-12, 25 or 100 pk, Black
- 75-656-W-25-100..... RG-8/RG-12, 25 or 100 pk, White
- 75-657-BK-25-100.....RG6 Dual, 25 or 100 pk, Black



75-500 Ba LUN Mat CHING t r a Ns f Or MEr

Convert 300 ohm antenna terminals on TV to 75 ohm RF connector. Frequency range 54-890MHz.

75-500-S Outdoor version with weather resistant rubber boot.



75-491 PUSH-ON 75 OHM Ca BLE t O 300 OHM t r a Ns f Or MEr

Convert 300 ohm antenna leads to 75 ohm Male 'F' push-on connector on a 6 foot cable.



75-480 1 GHz version 75-480-3 3 GHz version SINGLE "f" CONNECT Or Gr OUND BLOCK

Lighting arrestor/grounding block intercepts and sends harmlessly to ground lighting surges carried by coaxial cable shield. Protects VCR's, TV's, etc. Inserts into 75 ohm cable TV or antenna system.



75-481 1 GHz version 75-481-3 3 GHz version DOUBLE "f" CONNECT Or Gr OUND BLOCK

Lighting arrestor/grounding block intercepts and sends harmlessly to ground lighting surges carried by coaxial cable shield. Protects VCR's, TV's, etc. Inserts into 75 ohm cable TV or antenna system.



75-505 75-505G Gold version. UHF/VHf Out DOOr 2-Wa Y HYBr ID SPLIt t Er

Built-in grounding block. Protects against electrical surges.

- Specifications**
 Frequency Range.. 5-900 MHz
 Input 75Ω
 Output 75Ω
 Insertion Loss UHF-4 dB, VHF-3.5 dB
 Size 2" x 2 1/2" x 5/8"

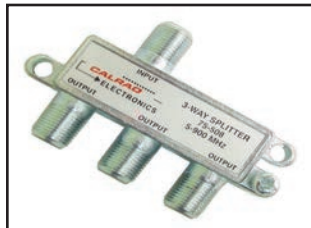

75-508 75-508G Gold version. UHF/VHf INDOOr 3-Wa Y HYBr ID SPLIt t Er

- Specifications**
 Frequency Range.. 5-900 MHz
 Input 75Ω
 Output 75Ω
 Insertion Loss -7 dB Port 1, 2, and 3
 Size 3" x 1 1/8" x 5/8"



75-509 75-509G Gold version. UHF/VHf INDOOr 4-Wa Y HYBr ID SPLIt t Er

- Specifications**
 Frequency Range.. 5-900 MHz
 Input 75Ω
 Output 75Ω
 Insertion Loss UHF-8 dB, VHF-7.5 dB
 Size 3" x 1 1/8" x 5/8"



75-503 6-Wa Y COaX Ia L SPLIt t Er

UHF/VHF indoor-outdoor splitter. 75 ohm. 1 input to 6 outputs. Frequency response of 5 to 900 MHz. Zinc die cast construction with mounting tabs and screws, built-in grounding block. Precision machined threads. Anti-corrosion plating and epoxy sealed.

75 Series - t V & r f -Cat V a ccessories

Technical drawings and specifications are available for these products. Please ask your Calrad sales representative for details.



75-507 8-Wa Y COaXia L SPLIt t Er
UHF/VHF indoor-outdoor splitter. 75 Ω. 1 input to 8 outputs. Frequency response of 5 to 900 MHz. Zinc die cast construction with mounting tabs and screws and cast in grounding black. Precision machined threads. Anti-corrosion plating and epoxy sealed.



75-710 1GHz 90dB isolation
75-715 1GHz 130dB isolation
2-Wa Y HIGH ISOLa t ION SPLIt t Er
5-1000MHz, 75ohm splitters with precision F connector threads, anti-corrosion zinc die cast case and mounting tabs with screws.
Specifications
Insertion Loss 3.4 - 4dB
Port to port isolation..... 21 - 24dB
Input return loss..... 15 - 20dB



75-711 1GHz 90dB isolation
75-716 1GHz 130dB isolation
3-Wa Y HIGH ISOLa t ION SPLIt t Er
3-way version of 75-710 & 75-715.
Specifications
1 Port Insertion Loss 3.5 - 4.5dB
2 Port Insertion Loss 6.8 - 8.2dB
Port to port isolation 20 - 25dB
Input return loss 15 - 18dB



75-712 1GHz 90dB isolation
75-717 1GHz 130dB isolation
4-Wa Y HIGH ISOLa t ION SPLIt t Er
4-way version of 75-710 & 75-715.
Specifications
75-712 Insertion Loss 6.8 - 8.2dB
75-717 Insertion Loss 7.0 - 8.2dB
Port to port isolation 20 - 25dB
Input return loss 15 - 18dB



75-713-2 2-Wa Y 1GHZ DIGIt a L SPLIt t Er
1GHz, 130dB splitter. Digital ready CATV splitters designed for hybrid distribution networks, voice-data, modem and digital converter applications. Fully water resistant. Soldered rear cover 130dB min, EMI-RFI shielding, DC blocked and IEEE-587 built-in 6kV surge protection at all ports. High performance components and circuitry. Anti-corrosion tin plated zinc-alloy, die cast housing. Mounting tabs with screws, cast-in ground block. Insertion loss 3.5-3.7dB max, isolation 35dB min, isolation 30 dB, 15-50 MHz. Return loss 22dB min.



75-713-3 3-Wa Y 1GHZ DIGIt a L SPLIt t Er
1GHz, 130db splitter. Digital ready CATV splitters designed for hybrid distribution networks, voice-data, modem and digital converter applications. Fully water resistant. Soldered rear cover 130dB min, EMI-RFI shielding, DC blocked and IEEE-587 built-in 6kV surge protection at all ports. High performance components and circuitry. Anti-corrosion tin plated zinc-alloy, die cast housing. Mounting tabs with screws, cast-in ground block. Insertion loss 3.5-3.7dB max, isolation 35dB min, isolation 21dB min 40MHz-1GHz. Return loss 22db min 15-40MHz.



75-713-4 4-Wa Y 1GHZ DIGIt a L SPLIt t Er
1GHz, 130dB splitter. Digital ready CATV splitters designed for hybrid distribution networks, voice-data, modem and digital converter applications. Fully water resistant. Soldered rear cover 130dB min, EMI-RFI shielding, DC blocked and IEEE-587 built-in 6kV surge protection at all ports. High performance components and circuitry. Anti-corrosion tin plated zinc-alloy, die cast housing. Mounting tabs with screws, cast-in ground block. Insertion loss 3.5-3.7dB max, isolation 35dB min, isolation 21dB min 40MHz-1GHz. Return loss 22dB min 15-40MHz.



75-713-6 6-Wa Y 1GHZ DIGIt a L SPLIt t Er
1GHz, 130dB splitter. Digital ready CATV splitters designed for hybrid distribution networks, voice-data, modem and digital converter applications. Fully water resistant. Soldered rear cover 130dB min, EMI-RFI shielding, DC blocked and IEEE-587 built-in 6kV surge protection at all ports. High performance components and circuitry. Anti-corrosion tin plated zinc-alloy, die cast housing. Mounting tabs with screws, cast-in ground block. Insertion loss 9.5-11dB max, isolation 35dB min, isolation 25dB min 40MHz-1GHz. Return loss 22dB min 15-40MHz.



75-713-8 8-Wa Y 1GHZ DIGIt a L SPLIt t Er
1GHz, 130dB splitter. Digital ready CATV splitters designed for hybrid distribution networks, voice-data, modem and digital converter applications. Fully water resistant. Soldered rear cover 130dB min, EMI-RFI shielding, DC blocked and IEEE-587 built-in 6kV surge protection at all ports. High performance components and circuitry. Anti-corrosion tin plated zinc-alloy, die cast housing. Mounting tabs with screws, cast-in ground block. Insertion loss 9.5-11dB max, isolation 35dB min, isolation 25dB min 40MHz-1GHz. Return loss 22dB min 15-40MHz.

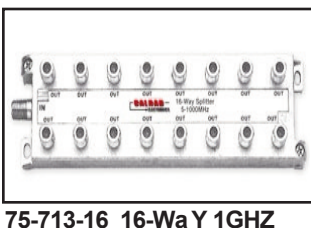

75-713-16 16-Wa Y 1GHZ DIGIt a L SPLIt t Er
1GHz, 130dB splitter. Digital ready CATV splitters designed for hybrid distribution networks, voice-data, modem and digital converter applications. Fully water resistant. Soldered rear cover 130dB min, EMI-RFI shielding, DC blocked and IEEE-587 built-in 6kV surge protection at all ports. High performance components and circuitry. Anti-corrosion tin plated zinc-alloy, die cast housing. Mounting tabs with screws, cast-in ground block. Insertion loss 9.5-11dB max, isolation 35dB min, isolation 25dB min 40MHz-1GHz. Return loss 22dB min 15-40MHz.



75-714-3 3-Wa Y 1GHZ DIGIt a L SPLIt t Er
1GHz, 130dB splitter. Digital ready CATV splitters designed for hybrid distribution networks, voice-data, modem and digital converter applications. Fully water resistant. Soldered rear cover 130dB min, EMI-RFI shielding, DC blocked and IEEE-587 built-in 6kV surge protection at all ports. High performance components and circuitry. Anti-corrosion tin plated zinc-alloy, die cast housing. Mounting tabs with screws, cast-in ground block. Insertion loss 5.5-5.9dB max, isolation 35dB min, isolation 21dB min 40MHz-1GHz. Return loss 22dB min 15-40MHz.



75-727 Dir ECT IONa L LINE t a PS
High quality directional couplers with solder back cases for over 125 dB of RFI shielding. Low thru port insertion loss and consistent levels of tap loss. Zinc diecast tin plated housing. Full 5-900MHz frequency range.
75-727-12 12 dB
75-727-16 16 dB
75-727-24 24 dB

CALRAD

75 Series - t V & r f -Cat V accessories



75-726
75 Ohm DC BLOCKER
 5-1750MHz, insertion loss 0.3dB, return loss 16dB typical. Nickel plated machined brass. Passes RF and blocks DC from the signal path. Male 'F' connector to F-81 style female. Overall length 1.6".



75 Ohm INLINE
attENUatOr
 0-1750MHz. Female to Male "F" attenuator. 5% tolerance with return loss of 20dB. 22 gauge spring steel center. DC power blocking.
75-720-3 3dB attenuation
75-720-6 6dB attenuation
75-720-8 8dB attenuation
75-720-10 10dB attenuation
75-720-16 16dB attenuation
75-720-20 20dB attenuation



75-479
COAXIAL SURGE AND SPIKE PROTECTOR
 Protects cable, TV converters, decoders, satellite receivers, access cards, VCRs and TVs from incoming surges and electrical spikes. Uses a standard Male-Female "F" connectors. Frequency: 2GHz. DC passive, Impedance: 75 Ohms, Insertion loss: .2dB.



75-504 DC GROUND BLOCKER & ISOLATION
trAnsformer
 75 ohm In/Out, Male 'F' connector to Female 'F' connector. Eliminates hum bars or audible hum generated when A/V components are connected directly to a cable TV or satellite system. Isolates ground potential differences within an Audio/Video system without affecting the RF signal. Frequency range 54-890MHz. 6" long.



75-725 16-20dB SLOPED 950-2250MHz amplifier
 High quality satellite RF inline amplifier suitable for DBS or MMDS satellite applications. Sloped gain for long cable runs. Epoxy sealed back cover plate. Power requirements 12-18Vdc, 45mA. DC pass through current 500mA maximum. Output level 105dBuV maximum. Low noise 5dB - input return loss 6dB. Impedance 75 ohms - frequency 40-2250MHz. High performance SMD board circuitry. Precision machined F-connector threads. Nickel plated zinc alloy diecast housing.



75-730-4, 4 Way 2GHz, 90dB Satellite Splitter
 Power passive to one port. Insertion loss 6.6-9dB max. Port-Port isolation 11-23dB min. Input return loss 12-15dB min. Zinc alloy die cast housing.



75-730-2, 2-Way 2GHz, 90dB Satellite Splitter
 Power passive to one port. Insertion loss 3.4-5.5dB max. Port-Port isolation 11-15dB min. Input return loss 12-15dB min. Zinc alloy die cast housing.



75-731-2, 2-Way 2GHz, 90dB Satellite Splitter
 Power passive to all ports. Insertion loss 4-4.5dB max. Port-Port isolation 12-15dB min. Input return loss 12-15dB min. Zinc alloy die cast housing.

75-731-4 4 Way 2GHz, 90dB Satellite Splitter
 Power passive to all ports. Insertion loss 6.7-11dB max. Port-Port isolation 11-15dB min. Input return loss 12-15dB min. Zinc alloy die cast housing.



75-705-a Satellite Diplexer-Mixer
 Size: 2.25" X 2" X 5/8" (W/D/H)
 5-2050MHz satellite splitter-combiner separates or combines off-air TV antenna and satellite signals from a single feed-line. High performance printed board circuitry. Anti-Corrosion chromate zinc-alloy die cast housing 90dB min RFI shielding - epoxy sealed back cover. .5" precision machined 'F' connector threads. DC pass-through current 500mA max. Insertion loss VHF-UHF 0.5dB - satellite 1.5dB. Isolation VHF 25dB - UHF 20dB - satellite 23dB. Return loss VHF 18dB - UHF 10dB - satellite 12dB.



CALRAD

75 Series - t V & r f -Cat V accessories



75-496
a + B t V a Nt ENNa
VCr & Ca BLE SWIt CH
 75 ohm inputs/output for hook-up of outdoor TV antenna or MATV outlet cable TV or VCR to TV set. 40dB isolation.



40-695a
a/B COa Xla L
PUSHBUt t ON r f SWIt CH
 High isolation RF A/B pushbutton switch. Complies with FCC part 15.6. 75 ohm RF "F" Female connectors. Lets you select from two inputs. Reversible. 80dB isolation. Frequency 5-900 MHz.



40-696
a/B/C COa Xla L
PUSHBUt t ON r f SWIt CHER
 High isolation RF A/B/C pushbutton switch. Complies with FCC part 15.6. 75 ohm RF "F" Female connectors. Lets you select from three inputs. Reversible. 90dB isolation. Frequency 5-900 MHz.



75-728 a nalog Meter
75-729 Digital Meter
Sa t ELLIt E f INDEr MEt Er S
 Highly sensitive meters. 75ohm, frequency range 950-2050MHz input. Sensitivity 7mV @ 55dB, LNB Gain 3-Carrier C/N 15dB, Input level -25dBm to -75 dBm, LNB gain 52-60dB, power requirement 13-18Vdc from existing coax feed. Requires 6dB attenuator for 60-65dB LNB.
75-728 has a built-in buzzer



75-486
UHf /VHf /f M a MPLIf IEr - 20dB
 Amplifier with adjustable gain control. 20dB amp. Switchable FM attenuation trap, ON-OFF indicator light. Frequency response of 5 to 900 MHz. Size: 1.47"(H) x 2.93"(W) x 5.65"(L).



75-488
UHf /VHf /f M a MPLIf IEr - 10dB
 4 way 10dB RF amplifier. Strengthen signals from VHF, FM mid and superband cable TV. Frequency response of 54MHz to 890MHz.



75-569
f ULL CYCLE r at CHET
Cr IMPING t OOL
 Full-cycle ratchet crimping tool for F, BNC, TNC Connectors RG-58, RG-59, RG-62, Rg-6 & PIN. Jaw Sizes: .0213", .256", .324", PIN = .068".



75-560
Cr IMPING t OOL
 Crimping tool for installing F-56, F-59 connectors and others on coax cables. Crimper has 2 openings for various diameter ferrules.



75-598
COMPr ESSION
Cr IMPING t OOL
 Crimping tool for (CATV) type weather proof compression connectors (RG-59, RG-6, tri/quad shields). For use with Calrad 75-533-PS, 75-534-PS series connectors, including Quad versions.



75-599a
COMPr ESSION
Cr IMPING t OOL
 Crimping tool for (CATV) type weather proof compression connectors (RG-59, RG-6, tri/quad shields). Comes with interchangeable dies for RCA, BNC and 'F' Connectors. Dies attach to tool handle for easy storage and access. For use with Calrad 75-533-PS, 75-534-PS, series connectors, including Quad versions



Visit Calrad on the web at: www.calrad.com

CALRAD

75 Series - tools & antennas

75-804
XM Sat ELLIt E r a DIO
a Da Pt Er r f t O SMB



t ELES COPING
a Nt ENNa S

75-469 6-Section
 3 ft. Extended
 8¹/₂" Collapsed



90-945
r Ot ar Y COa Xla L
St r IPPING t OOL
 Prepares cable for RG-58,
 RG-59/62, RG-6. No
 replacement cassettes
 needed. Includes hex wrench
 for adjusting cutting blades.
 Stripping distance 4mm, 6mm,
 8mm, 12mm.



75-471
CB t ELES COPING
a Nt ENNa

10-Section, coil loaded.
 Excellent CB replacement
 antenna. Extends to 47¹/₂",
 collapses to 7¹/₁₆", base
 diameter is ³/₃₂".



75-724 SECUr It Y SHIELD
t OOL
 Use this tool to remove the
 security barrel that is placed over
 most feedlines from CATV
 companies. Works on Calrad
75-724-MS
 metal screw on shield.
75-724-PO
 metal push on shield.

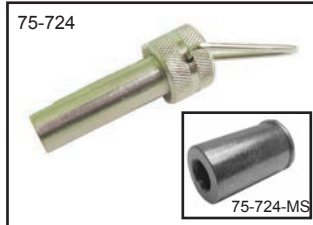

a Ut O a Nt ENNa LEa D
EXt ENSIONS

Motorola-type plug to Motorola-
 type jack. RG59U cable.

75-450 18"
75-451 24"
75-452 48"
75-453 96"
75-454 144"



75-472
f M Or t V f OLDED
DIPOLE a Nt ENNa
 Flexible tabs on end of wire for
 easy attachment to back of
 cabinet. 300 ohm.



"f" t O MOt Or OLa
a Nt ENNa Ca BLE

"F" Male to Motorola plug
 antenna cable, RG-59U cable.

75-452f -3 3 ft.
75-452f -4 4 ft.
75-452f -5 5 ft.
75-452f -6 6 ft.



75-502
75 t O 300 OHM Ba LUN
Wit H UHf /VHf /f M
SPLIt t Er
 Input 75 ohms, output 300 ohms
 UHF/VHF/FM



t V Wall Plate with Gold f
Connector

75-493Ivory
75-493-WWhite
75-493-SS ...Stainless Steel (New)

2 GHz Versions

75-493-2Ivory
75-493-WH-2white
Blank Single Gang Wall Plates
75-494-WWhite
75-494-IVIvory



CALRAD

75 Series - r f Connectors

"f" CONNECT Or S & a Da Pt Er S

QS = QUAD SHIELDED
VER SION a Va ILa BLE



75-493-ID
Ivory Designer
75-493-WD
White Designer
75-493-SS
Stainless steel wall
plate with single
"F" connector.



Wall Plates with
Dual F-81 Connectors.

75-489-ID Ivory Designer
75-489-IV Ivory
75-489-W White
75-489-WD White Designer
2 GHz Versions
75-489-IV-2 Ivory
75-489-WH-2 White

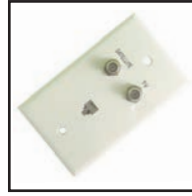

75-735-IV
75-735-W
Satellite, TV wall
plate built-in diplexer
with TV ant., satellite
and 4 conductor
telephone jack.
Available in ivory or
white.



75-736-IV
75-736-W
Combo wall plate
with 2 (F-81) coax
jacks and 1
conductor
telephone jack.
Available in ivory or
white.



75-510
2-piece crimp
connector for RG59
cable.
75-510G
Gold version.



75-510-r G11
2-piece crimp
connector for RG11
cable.



75-512
F-56 Connector.
2 piece crimp.
Connector fo RG6
cable.



75-529
"F" push-on plug.
Crimp style for
RG59 cable.



75-511
F-59 connector with
ferrule attached for
RG59 cable.
75-511G
Gold version.



75-513
F-56 Connector with
ferrule attached.
For RG-6 cable.



75-533 - F-59
"F" connector with
long crimping barrel.
75-533G
Gold version. 1/2"
barrel.



F connectors with
long crimping barrel
for RG-6
75-534 - F-56
75-534G
Gold version
75-534-WP
Weather proof version
75-534-Q
Quad version



75-538
Twist-on F-59
connector for RG-59
75-538G
Gold version.



75-608
Twist-on connector
for RG-6.
75-608G
Gold version.



75-608S-r G59
75-608S-r G6
Quick one-step push on
installation connectors
suitable for coaxial broadband
networks used in video and
data. Precision machined
annealed brass construction.
Anti-corrosion nickel plated
finish. Used with multiple
cable braid and shield types.
RG59 or RG6 standard, tri-
shield and quad shield cable.
Internal neoprene O-ring
provides a weather sealed
connection. 7mm heavy duty
easy-grip nut.



75-533-SN59 RG-59
75-534-QS Quad RG-6
'F' snap-n-seal connector is
environmentally sealed to
protect drops from harsh
environments. Through a
unique 360° compression
process, this type of
connector provides
protection against signal
leakage, required for
today's high-bandwidth
CATV systems. Use with
Calrad 75-599A or 75-598
compression tool.



75-534-PL Nickel
75-534G-PL Gold
Plenum RG6 "F"
Connectors.
Plenum connectors in
gold or nickel.
Threaded interior
crimp for secure
cable installation.
Connector face has
waterproof boot to
prevent moisture
from contaminating
the connection.



75-755 RG-59
High end solder
type 'F' connector
with black chrome
plated barrel, gold
plated 75 ohm
connector with
teflon insert. .255"
cable opening.



75-756 RG-6
High end solder
type 'F' connector
with black chrome
plated barrel, gold
plated 75 ohm
connector with
teflon insert. .32"
cable opening.



75-518
Female "F" fitting to
Male RCA type
plug adapter.
75-518G
Gold version.



30-387 gold
30-387-NK nickel
Heavy Duty RCA
Plug for use on
cable up to RG59
coax. Spring strain
relief. Cable
opening = .28"
Comes in gold or
nickel plating.



**Water resistant
Compression Style
Connectors**
Nickel Version
75-533-PS-r Ca RG59
75-534-PS-r Ca RG6
Gold Version
75-533G-PS-r Ca RG59
75-534G-PS-r Ca RG6
75-534Q-PS-r Ca
Quad Shield Version RG6



75-537
RCA phone plug
w/ crimping ring for
RG-59/U cable.
75-537G
Gold version RG-59
75-537-r G6
RG-6 Version

CALRAD

75 Series - Video & r f Connectors

"f" CONNEct Or S & a Da Pt Er S . . . continued



75-539
Adapter for TV, video and cable. Female F-81 Jack to Male 3.5 mm mini plug.



75-604
Chassis mount "F" Female connector. Mounts from rear with hardware. Mounts in .375" chassis hole.



75-519
F-61A type chassis connector. Female "F" mounts in .375" chassis hole with nuts & washer.

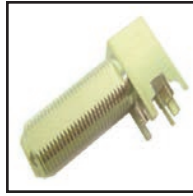

75-625
Right angle PC mount "F" connector with long shaft.

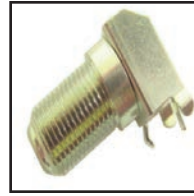

75-626
Right angle PC mount "F" connector with short shaft. Mounts in .375" chassis hole.

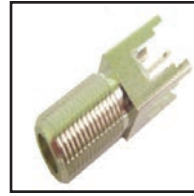

75-531
Circuit board mount "F" Female type.
75-531G
Gold version. Mounts in .375" chassis hole.



75-750
1 & 2 Ghz F-81 Feedthrus. 1Ghz for cable, TV, 2 GHz for satellite receivers
75-750-1 (1 GHz, 3/8")
75-750-1 (1 GHz, 3/8") Gold)
75-750-2 (2 GHz, 3/8")
75-750-2 (2 GHz, 3/8") Gold)
75-750-1/2-1 (1 GHz, 1/2")
75-750-1/2-2 (2 GHz, 1/2")
75-750G-1/2-1 (1 GHz, 1/2") Gold)
75-750G-1/2-2 (2 GHz, 1/2") Gold)
75-750-3 (3 GHz, 3/8")



75-520DD-WH
Silver plated "F" to "F" 3/8" type RF coupler. Double D cut with hardware



75-520
F-81C type coupler. "F" to "F" type coupler. Mounts in .375" chassis hole.
75-520 3/8" standard
75-520G 3/8" gold version
75-520-1D 3/8" single D cut
75-520-2D 3/8" double D cut
75-520-WH with hardware
75-520-1/2 1/2" version
75-520G-1/2 1/2" gold version



75-556
"F" Female to RCA Female.



75-635G
Gold Female to RCA to "F" bulkhead connector. Panel mount double "D" connector mounts in 3/8" hole. Overall length .95". "F" thread length .57". Mounting hardware included.



75-635a-COLOR
Female "F" to RCA Female Same as 75-635 only with hex style bulkhead. Available with colored RCA dielectric. Specify color when ordering. Available in Black, Blue, Green, Red, Yellow and White.



75-635a G-COLOR
Female "F" to RCA Female Same as 75-635A hex style Gold Version Bulkhead. Available with colored RCA dielectric. Specify color when ordering. **available in black, blue, green, red, orange, yellow, and white.**



75-522
RCA Female to "F" Male.



75-525
UHF Female to "F" Male.



75-565
"F" Male to Male adapter.



75-565-PO
"F" Male to Male Push-on coupler



75-528
BNC Female to "F" Male.

75-528G
Gold Version.

75-698
75 ohm Version



75-567
BNC Female to Push-on-F Male connection.



75-530
Push-on adapter. "F" Male (push-on) to "F" Female.

75-530G
Gold version.



75-532
RCA Female to "F" push-on Male.

75-532G
Gold version.



75-535
Right angle adapter. "F" Male to "F" Female.

75-535-2
2 GHz Version



75-535-PO
Right angle, push-on "F" Male to "F" Female.



75-568
r f t erminator
75-568HQ
High Quality Gold Male r f t erminator.

75 Ohm Male terminator. Easy finger grip design and solid center pin. Red ID band labeled 75 Ohm.

75 Series - Video & rf Connectors & accessories

Technical drawings and specifications are available for these products. Please ask your Calrad sales representative for details.

****Please Note: for 75-533-PS & 75-534-PS Series, images and specifications are subject to change****

Water Resistant Compression Style Connectors.

These easy to use compression style connectors are the perfect solution for your coaxial broadband network needs. Used in video, data and telephone, Water Resistant Compression Style Connectors offer 360° radial compression. Water Resistant Compression Style Connectors come fully weather sealed with superior RF shielding and internal neoprene O-ring weather sealed wide 7mm heavy duty easy grip nut. They are precision machined, annealed brass construction with anti-corrosion nickel plated or gold finish. Comes in "F", RCA and BNC versions, with some models available in right angle and Female configurations. Used in conjunction with Calrad 75-599A or 75-598 crimping tools. Please note: due to different cable manufacturing specifications, some connectors may not work with all cable types.



Water Resistant Compression Style Connectors

RG-59
 75-533-PS.....Nickel
 75-533G-PS.....Gold
 75-533-PS-PO.....Push-on Nickel
 75-533G-PS-PO.....Push-on Gold
 75-533-PS-ra.....Right Angle Nickel
 75-533G-PS-ra.....Right Angle Gold
 75-533f-PS.....Female Nickel
 75-533f G-PS.....Female Gold

RG-6
 75-534-PS.....Nickel
 75-534G-PS.....Gold
 75-534-PS-PO.....Push-on Nickel
 75-534G-PS-PO.....Push-on Gold
 75-534-PS-ra.....Right Angle Nickel
 75-534G-PS-ra.....Right Angle Gold
 75-534f-PS.....Female Nickel
 75-534f G-PS.....Female Gold

Water Resistant Compression Style Connectors

RG-59
 75-533-PS-ra.....Right Angle Nickel
 75-533G-PS-ra.....Right Angle Gold
 75-533-PS-ra.....Right Angle Nickel
 75-533G-PS-ra.....Right Angle Gold

RG-6
 75-534-PS-ra.....Right Angle Nickel
 75-534G-PS-ra.....Right Angle Gold
 75-534Q-PS-ra.....Quad Shield, Nickel
 75-534Q-PS-ra.....Quad Shield, Gold
 75-534-PS-ra.....Right Angle Nickel
 75-534G-PS-ra.....Right Angle Gold

RG-174
 75-534-PS-ra-174.....Nickel

Water Resistant Compression Style Crimping Tools 75-598 and 75-599a

Water Resistant Compression Style Connectors

RG-59
 75-533-PS-BNC.....Nickel
 75-533G-PS-BNC.....Gold
 75-533-PS-BNC-ra.....Right Angle Nickel
 75-533G-PS-BNC-ra.....Right Angle Gold

RG-6
 75-534-PS-BNC.....Nickel
 75-534G-PS-BNC.....Gold
 75-534Q-PS-BNC.....Quad Shield, Nickel
 75-534Q-PS-BNC.....Quad Shield, Gold
 75-534-PS-BNC-ra.....Right Angle Nickel
 75-534G-PS-BNC-ra.....Right Angle Gold



75-598
COMPRESSION CRIMPING TOOL
 Crimping tool for (CATV) type weather proof compression connectors (RG-59, RG-6, tri/quad shields). For use with Calrad 75-533-PS, 75-534-PS series connectors, including Quad versions.



75-599a
COMPRESSION CRIMPING TOOL
 Crimping tool for (CATV) type weather proof compression connectors (RG-59, RG-6, tri/quad shields). Comes with interchangeable dies for RCA, BNC and 'F' Connectors. Dies attach to tool handle for easy storage and access. For use with Calrad 75-533-PS, 75-534-PS, series connectors, including Quad versions

BNC RUBBER BOOT S

for use with 2 piece BNC connectors. These boots can be cut and used for other cable strain relief applications. Black PVC rubber.



75-780-r G-59
 Cable O.D. max .28", connector sleeve O.D. max .35" 1.69" overall length.

75-780-r G-58
 Cable O.D. max .22", connector sleeve O.D. max .35" 1.72" overall length.

75-780-r G-174
 Cable O.D. max .17", connector sleeve O.D. max .35" 1.74" overall length.



75-696K-S Solderless BNC Mount Jack

Solderless BNC jack. Mounts in either 1/2" hole or keystone insert. Individual "U" shaped slotted screw terminals provide secure termination of 18-30 Ga wires. 30-287 Colored "ID" washers are available.

CALRAD

75 Series - Video & r f Connectors

BNC CONNECT Or S & a Da Pt Er S



75-542
75-542G (Gold)
Gold BNC Male for
RG-58/U and RG-
55/U cables.
Solder style.



75-551
BNC Male
connector for
RG-59,
solder style.



75-549
Solderless
screw-on BNC
Male for
RG-59/U.
75-549G
Gold Version



75-550
Same as 75-549,
except for
RG-58/U and RG-
55/U, 8281 cable.



75-555
BNC crimp on
connector for RG-59
cable. 3 pcs.
75-555-t f E
Teflon version.
75-681
75 ohm version.



75-555-20
Same as 75-555
except contact pin
accepts 20 gauge
center conductor
cable.



75-610
BNC crimp on
connector for RG-6
cable. 3 pcs.
75-680
75 ohm version.



75-609
BNC crimp for RG-
59 cable. 2 piece.
75-609-t f E
Teflon version.
75-682
75 ohm version.



75-611
BNC crimp for RG-
58 cable.
3 piece.
75-607
75 ohm version.



75-687 (8218)
75-687-a (1855a)
BNC Male crimp
connector for
Belden 8218 or
1855A or the
equivalent cable. 75
ohm. 3 pieces.



75-686
BNC Male
connector for RG-
179U coax cable.
75 ohm.
3 pieces. Use with
Calrad 55-612B
cable.



75-684
BNC Male
connector for
RG-179U coax
cable. 75 ohm.
2 pieces.



75-612
BNC crimp
connector for
RG-58 cable.
2 piece.



75-613
BNC crimp
connector for RG-6
cable. 2 piece.
75-683
75 ohm version.



75-614
BNC dust cap
with chain.



75-r 21
Panel Mount
BNC f emale to
r Ca f emale
75-r 21-r D.....Red
75-r 21-WH....White
75-r 21-YL...Yellow

HIGH QUALITY BNC CONNECTORS

Perfect f or HDt V a p p l i c a t i o n s



75-800G-50
50 ohm.



75-800G-75
75 ohm.
RG-59 solder BNC
connectors, gold
with black chrome
body. .255" cable
opening.



75-801G-50
50 ohm. RG-179
solder BNC
connectors gold with
black chrome body
with rubber strain
relief. .12" cable
opening. For use
with Calrad RGB
cable 55-612B.



75-801G-75
75 ohm. RG-179
solder BNC
connector, gold with
black chrome body
with rubber strain
relief. .12" cable
opening. For use
with Calrad RGB
cable 55-612B.



75-802G-75
For RG-179.
.12" cable opening.
Use with 55-612B
cable

75-803G-75
For RG-59
75 ohm solder
Female BNC
connector, gold
with black chrome
body with rubber
strain relief. Cable
opening is .255".

CALRAD

75 Series - Video rf Connectors

BNC CONNEct Or S & a Da Pt Er S . . . continued

Please Note: f or 75-533-PS & 75-534-PS Series, images and specifications are subject to change



Right angle Water resistant Compression Style Connectors Nickel Version
 75-533-PSBNCr a RG59
 75-534-PS-BNCr a RG-6 Gold Version
 75-533G-PSBNCr a RG59
 75-534G-PSBNCr a RG-6



Water resistant Compression Style Connectors Nickel Version
 75-533-PS-BNC RG59
 75-534-PS-BNC RG-6 Gold Version
 75-533G-PS-BNC RG59
 75-534G-PS-BNC RG-6
 75-534Q-PS-BNC Quad Shield RG-6 Version



75-645
 50 Ohm BNC Female inline connector for RG-59. 3 piece crimp.



75-646
 RG-59 crimp BNC Female 2 piece.



75-566
 Inline BNC Female solderless screw on adapter for RG-58.



75-559-75
 75 ohm version
75-559
 50 ohm version Solderless BNC Male right angle connector for use with RG-59 coax cable. Cable opening .24". Black snap style plastic body.



75-559-St -75
 75 ohm version
75-559-St
 50 ohm version Solderless BNC Male connector for use with RG-59 coax cable. Cable opening .24". Black snap style plastic body.



75-554
 BNC right angle crimp connector for RG-58. 2 pcs.



75-561
 BNC Male to BNC Female right angle adapter.
75-693
 75 ohm version.



75-526
 BNC Female to "F" Female.



75-527
 BNC Male to "F" Male.



75-517
 "F" Female to BNC Male adapter.
75-517G
 Gold version.
75-679
 75 ohm version.



75-540
 "T" adapter, 2 BNC Females to 1 BNC Male.
75-690
 75 ohm version.



75-541
 BNC "T" with 3 Female BNC connectors.
75-691
 75 ohm version.



75-620
 4-way BNC "T" Connector, with 3 Females to 1 Male.



75-621
 3-way BNC "T" BNC Male connectors.



75-622
 3-way BNC "T" Connector, with 2 Males to 1 Female.



75-623
 BNC "T" Connector, with 1 Male to 2 Females.



75-624
 BNC "U" adapter, with 1 Male to 2 Females. U shape.



75-628
 Isolated BNC feed thru. True 75 ohm. Overall length 1.29". Mounts in .5" D hole.
75-628-50
 50 Ohm Version



75-552
 BNC feed thru double Female panel mount. Mounts in .5" D hole. Overall length is 1.28". Bushing length .33".
75-696
 75 ohm version



75-521
 Panel feed thru connector. BNC Female to RCA Female. Bushing dia.: .487" Bushing length: .33" Overall length is 1.29" Mounts in .5" hole. 75 ohm.
75-521-50
 50 Ohm version



75-543
 BNC Female chassis connector. Overall length is 1.08". Mounts in .375" chassis hole. Bushing length .28".
75-543G
 Gold version.
75-697
 75 ohm version.



75-521-3/8
 Panel feed thru connector. BNC Female to RCA Female. Bushing dia.: .365" Bushing length: .27" Overall length is 1.06" Mounts in .375" hole.

CALRAD

75 Series - Video r f Connectors

Technical drawings and specifications are available for these products. Please ask your Calrad sales representative for details.

BNC CONNECT Or S & a Da Pt Er S . . . continued



75-514
BNC Female, isolated ground from chassis. Length is 1.06". Mounts in .37" chassis hole. Bushing length .38".



75-515
BNC Female, chassis-mount. Length is 1.08".



75-685
BNC Female chassis mount jack for RG-174U cable. 75 ohm. Fits in a 1/2" "D" hole. Bushing length .33"

75-688
RG-59 version.



75-544
UHF Female to BNC Male.



75-563
RCA Male to BNC Male. Over all length is 1.55".



75-547
BNC Male to RCA Female.
75-547G
Gold version.

75-694
75 ohm version.



75-548
BNC Female to RCA Male.
75-548G
Gold version
75-548-S
Nickel body, Gold pin
75-695
75 ohm version.



75-562
BNC Male to BNC Male adapter. Overall length: 1.25".

75-699
75 ohm version



75-553
3.5 mm mini phone plug to a BNC-type Female connector.

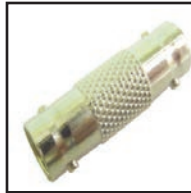

75-546
BNC Female to BNC Female. Over all length: 1.29".

75-546G
Gold version.
75-692
75 ohm version.



75-629
BNC Female to a RCA Female.



BNC t Er MINat Or S
75-600 - 50 ohm/5%
75-601 - 75 ohm/5%
75-602 - 93 ohm/5%
75-600-1 - 50 ohm/1%
75-601-1 - 75 ohm/1%
75-602-1 - 93 ohm/1%

UHF CONNECT Or S & a Da Pt Er S

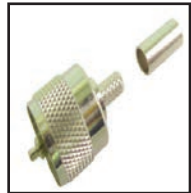

75-536
75-536-r G58
UHF Male with long crimp ring for coax. For use on RG-59 or RG-58 cable.



75-558
Right angle UHF Male connector for coax cable.



75-516
F-81 type Female to PL-259 type Male adapter.
75-516G
Gold version.



75-557
RCA Female to UHF Male.



75-545
UHF Male to BNC Female.



75-564
SO-239 Female to BNC Female.



75-524
UHF Female to "F" Female.



30-469
UHF universal jack adaptor. Adapts SO-239 to Motorola-type auto antenna jack or RCA-type phone jack.



30-470
UHF right angle adapter SO-239 to PL-259.



30-471
UHF "T" connector adapts 2 Females to one Male.



30-472
UHF double Female connector.



30-473
for RG58U.
30-474
for RG59U.
Coax cable adaptor Both for use with 30-465.

75 Series - Video r f Connectors, t NC, Pa L

Technical drawings and specifications are available for these products. Please ask your Calrad sales representative for details.



30-465
Coax cable
connector plug.
PL-259



30-467
S0-239 Coax
chassis connector
(box-type).



30-468
S0-239 Coax
chassis connector
(bullet-type).
5/8" hole size.



30-475
Coax adaptor plug.
Adapts S0-239
type to
3.5 mm jack.

For New Product
Information
Please Visit Us at:
www.calrad.com

t NC CONNECT Or S & a Da Pt Er S



75-580
Male TNC
connector, 3 piece
crimp for RG-
59/62.



75-630
TNC push-on
connector, 3 piece
crimp for RG-59.



75-579
Female TNC
chassis mount 3/8"
connector.



75-583
TNC Male
connector to
PL-259 Female
adapter.



75-584
Male TNC
connector to
BNC Female.



75-585
TNC push-on Male
to TNC Female.



75-586
Right angle TNC
Male to Female
coupler.



75-587
TNC Female
coupler.
Overall length:
1.28".



75-631
TNC, 2 piece crimp
plug for RG-59.



75-590
Pal connector.
Male Pal solderless
uses RG-59 coax
cable.



75-591
Pal connector.
Female Pal
solderless uses
RG-59 coax cable.



75-592
Pal connector.
Male Pal to
Female Pal.



75-593
Pal connector.
Female Pal to
Female Pal.



75-594
Pal connector.
Male Pal to Male
Pal.



75-595
Pal connector.
Female Pal to
Male "F".



75-596
Pal connector.
Male Pal to
Female "F".



75-588
Mini UHF Male to
TNC Female.



75-589
Mini UHF Female
to TNC Male
coupler.

Pa L CONNECT Or S & a Da Pt Er S

CALRAD

75 Series - r f Connectors, Mini UHF, N, SMA

Technical drawings and specifications are available for these products. Please ask your Calrad sales representative for details.

MINI UHF CONNECTOR S & a Da Pt Er S



75-615
Mini UHF Male crimp connector, 3 piece for RG 58, nickel plated.
75-615-BK
Black Version.



75-616
Mini UHF Female coupler. Overall length: 1.29\"



75-617
Mini UHF Male to Female right angle coupler.



75-618
Mini UHF Male crimp connector, 2 piece for RG 58.



75-570
Male "N" connector for RG-8/11, 213/214.



75-571
Double Female "N" connector.



75-572
Chassis mount Female "N" connector. Over all length is 1.09". Mounts in chassis .62" hole.



75-573
BNC Male to "N" Female.
75-575
BNC Female to "N" Male.



75-574
"F" Female to "N" Male connector.



75-576
PL-259 Male to "N" Female connector.



75-577
UHF Female to "N" Male.



75-640
Male to Male "N" connector.

SMA CONNECTOR S



75-641
Female to Male right angle "N" connector.



75-642
"T" adapter, Female "N" to Male "N" to Female "N".

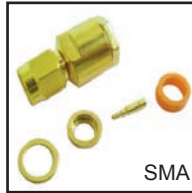

75-760
Male SMA connector for RG58A. Nickel plated brass construction, gold plated contacts with teflon insulator.

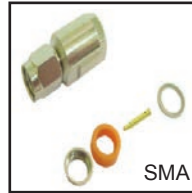

75-761
Male SMA connector for RG59/62. Nickel plated brass construction, gold plated contacts with teflon insulator.



75-762 RG58A
75-763 RG59/62
Male SMA 3 piece crimp connector for. Nickel plated brass construction, gold plated contacts with teflon insulator.

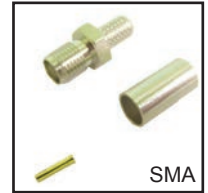

75-764
Female SMA 3 piece crimp connector for RG58A. Nickel plated brass construction, gold plated contacts with teflon insulator.



75-765
Female SMA 3 piece crimp connector for RG59/62. Nickel plated brass construction, gold plated contacts with teflon insulator.

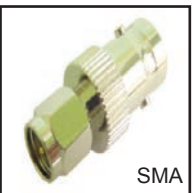

75-766
BNC jack to SMA plug. Nickel plated brass construction, gold plated contacts with teflon insulation.



75-767
Male to Female SMA Right angle inline adapter.



75-768
Female to Female SMA inline adapter. Nickel plated brass construction, gold plated contacts with teflon insulator.



Visit Calrad on the web at: www.calrad.com

80 Series - Preamps, Cleaning Products

Technical drawings and specifications are available for these products. Please ask your Calrad sales representative for details.



80-575-H HEaDPHONE aMP
80-575-M MICrOPHONE PrE-aMP

80-575-L LINE PrE-aMP
80-575-P PHONO PrE-aMP

Select from 4 standard stereo configurations. A few components are easily changed on the PC board for each preamp. The unit is available in a chassis, or completed circuit board with labeled black face plate. Includes DC power adapter. Optional RCA to XLR adapter cable 10-142-5 for mic preamp.

Specifications

Input/Output Jacks	RCA Type	Output Impedance	5K, Factory Adjusted
Power	9VDC, 2.5mm Coax Jack	Gain	Adjustable
Input Impedance	Factory Adjusted	Frequency Response .	20HZ - 20KHZ, + - 3 DB
Size	4.5" L x 3" W x 1.5" H		



REAR VIEW



10-142-5

80-507
VIDEO CHaMOIS SWaBS
 For cleaning of video tape heads. 5 1/2 inches in overall length. 10 per pkg.



80-574
StErEO PHONO PrEaMP
 Stereo phono preamp with external low noise DC power supply. RCA IN/OUT. Input: 5mv/100K ohm / 1khz maximum input: 30mv. Frequency response:18-20khz. S/N ratio: >50db. 12Vdc power supply included. Shielded metal chassis.



80-508
aNtI-StatIC CLEaNING SWaBS
 For computer equipment. 6 inches in overall length. 100 per pkg.



80-510
HEaDCLEaNING SOLUtION
 For video and audio heads, tape guides and tape rollers. 1/2 oz. bottle



80-505
WOODEN HaNDLE COt tON SWaBS
 Pointed tip for cleaning audio and video products. 6 inches in overall length. 100 per pkg.

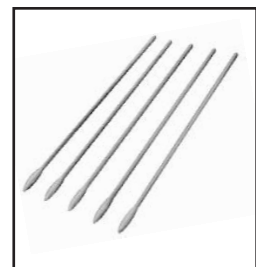

80-506
WOODEN HaNDLE COt tON SWaBS
 Standard round tip for cleaning audio and video products. 6 inches in overall length. 100 per pkg.



80-405
f aX/LaSEr Pr INtEr CLEaNING Kit
 Comes complete with cleaning solution, 5 cleaning chamois, blower brush, special cleaning paper, and cloth.



CALRAD

80 Series - audio & Video Cleaning Kits

80-410

MOUSE CLEANING Kit

Comes complete with cleaning solution, 5 cleaning chamois, and circular cleaning brush tool.



80-404

DVD/CD-ROM CLEANING Kit

Comes complete with cleaning solution and circular cleaning pad. Cleans finger prints, dust, and minor defects from the disc.



80-408

GAME CONSOLE AND

CARTRIDGE CLEANING Kit

Comes complete with cleaning solution and 3 cleaning cards. For use with Sega consoles and game cartridges.



80-411

CLEANING WIPES

50 pieces
Used for CD, DVD, VCD, keyboard, monitor, fax machines, etc. Complete with sealed storage case.



80-412

GAME CLEANER

Cleans game cartridges and game unit slots, removes dirt and oxidation restoring contact points to normal operation. Works with Nintendo®, Gameboy, Nintendo® NES™, Sega™, NEC™ and more. Includes cleaning solution and 4 cleaning wands.



80-413

MINI DISC HEAD AND LENS CLEANER

Easy and effective way to clean all mini disc systems, requires only 10-15 seconds for the complete cleaning cycle.



80-407

MULTIMEDIA PC CLEANING Kit

Comes complete with cleaning solution, mini electric vacuum with collection bag with 2 attachments, 5 cotton swabs, monitor lens cleaning tissue, CD-Rom and 3.5" cleaning disks.



80-815

HD-CARE SCREEN CLEANER

HD-Care – is a gel based LCD cleaner, designed to care for all your LCD components. In its conception our customers told us that a non drip, smell good cleaner at a low price would be a hit. So we listened, introducing HD-Care screen cleaner, a 6.76 fl oz spray used to care for LCD TV's, plasma flat panel TV's, DLP projection TV's, CRT Tube TV's, laptop LCD screens, computer monitors, digital picture frames, restaurant ordering screens and more. Each package includes cleaning cloth.



HD-CARE
Screen Cleaning Kit

80-403

DVD LENS CLEANER AND A/V HOME THEATER TEST DISC

This disk provides cleaning of the laser lens assembly and testing for home theater systems. 5.1 mode, AC-3, color adjustment test patterns. Video animation sequences, random video scenes. Voice guide and music for each selection.



80-566

MINIATURE TELEPHONE PICK-UP COIL

Suction cup type, attaches to phone permitting both ends of a telephone conversation to be recorded with no wiring necessary. Has 3.5mm miniature plug.



CALRAD

85 Series - Knobs & Dials

MULTI-COLOR ED KNOBS



Black base with color caps available in 5 different colors. $\frac{1}{4}$ " I.D. brass bushing. $\frac{9}{16}$ " DIAMETER $\frac{9}{16}$ " HIGH

85-590.....Red
85-591.....Grey
85-592.....Yellow
85-593.....Green
85-594.....Blue



Black base with color caps available in 5 different colors. $\frac{1}{4}$ " I.D. brass bushing. $\frac{3}{4}$ " DIAMETER $\frac{5}{8}$ " HIGH

85-595.....Red
85-596.....Grey
85-597.....Yellow
85-598.....Green
85-599.....Blue



85-559
1 $\frac{1}{4}$ -inch, black pointer knob. $\frac{1}{4}$ -inch brass bushing with set screw. .60" high.



85-580
Black 1" diameter control knob $\frac{9}{16}$ " high with set screw. .62" high.



Serrated grip with attractive chrome edge, $\frac{1}{4}$ -inch brass bushing with set screw.

85-577 $\frac{9}{16}$ " x $\frac{7}{16}$ " high
85-578 $\frac{3}{4}$ " x $\frac{9}{16}$ " high
85-579 1" x $\frac{11}{16}$ "



85-571
Black bakelite knob. Fluted grip, $\frac{1}{4}$ -inch brass bushing with set screw. $\frac{15}{16}$ " Diameter, $\frac{9}{16}$ " high.



85-561
Black, bakelite knob with chrome insert, fluted grip. $\frac{1}{4}$ -inch brass bushing with set screw. $\frac{3}{4}$ " Diameter, $\frac{9}{16}$ " high.



85-572
Black bakelite with aluminum insert, fluted grip. $\frac{1}{4}$ -inch brass bushing with set screw. 1" Diameter, $\frac{3}{4}$ " high.



85-569
Black bakelite, aluminum insert. Fluted grip, $\frac{1}{4}$ -inch brass bushing with set screw. 1" Diameter, $\frac{1}{2}$ " high.



85-574
Black bakelite, aluminum insert. Fluted grip, $\frac{1}{4}$ -inch brass bushing with set screw. 1 $\frac{5}{16}$ " Diameter, $\frac{5}{8}$ " high.



85-560
Black, bakelite knob. Fluted grip, $\frac{1}{4}$ -inch brass bushing with set screw. $\frac{3}{4}$ " Diameter, $\frac{7}{16}$ " high.



85-567
Chrome-skirted instrument knob. Calibrated 0-9. Fluted ebony grip with aluminum insert for $\frac{1}{4}$ -inch shaft with set screw. (Diameter $\frac{3}{16}$ ") .68" high.



85-575
Calibrated 0-10, chrome numbers on skirt. Size $1\frac{3}{16}$ " x $\frac{3}{4}$ " with $\frac{1}{4}$ " brass bushing. .75" high.



85-660
Black Easy grip, knurled control knob. White number 0-10 imprinted on skirt. $\frac{1}{4}$ -inch brass bushing. $\frac{7}{8}$ " high, 1 $\frac{7}{16}$ " diameter.



85-663
Grey Same specs as 85-660, except without numbers.

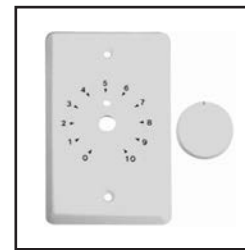

WHIT E a ND IVOr Y KNOBS a ND PLat ES

For use with 25-351, 25-351A, 25-339, 25-339A, 25-357, and 25-357A. Plates have numbers 0-10. Knob is 1 $\frac{5}{16}$ " in diameter and accepts $\frac{1}{4}$ " shafts.

85-565-IDIvory Designer Style Knob
85-565-WDWhite Designer Style Knob
28-140-W White Wall Plate

CALRAD

90 Series - Test Lead Clips, Alligator Clips & Battery Holders

90-781

Test Lead Set

Features 5 color-coded leads, terminated with wire hooks for hands free testing. 5 colors: Black, Green, Red, White and Yellow



90-768

Alligator Clips

Kit of 5 alligator clips. Nickel plated with screw terminals. Also fits banana plugs.



90-767

Test Clip Set

Thin wire kit of 10 leads, 15" long. Miniature insulated alligator clip each end. (2 each of 5 colors: Black, Green, Red, White and Yellow) #27 awg wire.



90-771 2 Black, 2 Red

90-771-BK 2 Black

90-771-r 2 Red

Alligator Clips With

Insulated Handles

Insulated alligator clips. Screw terminals. Also fits banana plugs.



90-764

Same as 90-767, but with medium weight clips and wire. Colors: Black, Green, Red, White and Yellow. #21 awg wire.



90-772

Battery Connector S

Completely insulated, snap fastener type with color-coded leads. Made to fit flat 9-volt and miniature 45-volt batteries with 1/2" connector spacing.

Available with 2 1/2", 4", 6 1/2", and 8" leads.

90-772-2.5..... 2.5" leads

90-772-4..... 4" leads

90-772-6.5..... 6.5" leads

90-772-8..... 8" leads



90-770

Heavy Duty

Test Clip Leads

Heavy duty, flexible wire, insulated clips. Four 30" cables Colors: Black, Green, Red and Yellow. #18 awg wire.

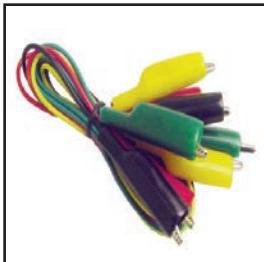

90-772M

Molded 9-volt battery clip with 6" leads.

SNAP-IN "aa"

Battery Holder S

Sturdy, plastic, lightweight construction. For use with radios, recorders, school projects and many transistor applications. Will accommodate 1 1/2-volt penlight batteries.

90-773 2 cell holder (less batteries)

90-774 4 cell holder (less batteries)

90-775 2 cell holder (less batteries)

90-777 8 cell holder (less batteries)

90-779 4 cell holder (less batteries)

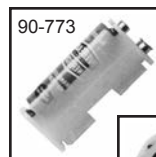

Robust Insulated

Alligator Clips

Sturdy nickel plated jaws with strong spring and hard bite. 1 1/2" long. Specify color.

90-765.....Black

90-766.....Red



90 Series - Battery & fuse Holders, Speaker terminals

"aaa" Battery HOLDER S

Made of durable plastic shell and nickel plated contacts to stop corrosion from battery acid. All have 6 inch leads (red and black).

- 90-745.** 1 cell holder (less batteries)
- 90-746.** 2 cell holder (less batteries)
- 90-747.** 4 cell holder (less batteries)

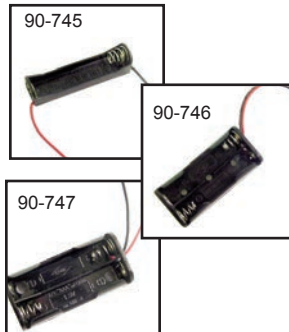

90-811 UNIVER Sa L INLINE f USE HOLDER

Consists of insulated plastic fuse holder and 25"-wire. Handles 3AG-type 10A 125V fuses included. Excellent for home, auto radios and tape players. 20 gauge wire.



90-780 Sa f Et Y f USE HOLDER

Panel mounting for 3AG-type fuses. Fits in panels up to $\frac{3}{16}$ " thick, $\frac{19}{32}$ " mounting hole. Overall length $1\frac{3}{4}$ " behind panel $1\frac{15}{16}$ ". Rating 10 amps / 250 Vac



90-818 HEa VY DUt Y INLINE f USE HOLDER

10-gauge wire with 30-Amp fuse included. Length is 13".



90-783-UL f USE HOLDER UL Ver SION

Panel mounting fuse holder for 3AG fuses. Mounts in .59" hole. $1\frac{1}{4}$ " deep behind panel. Rating 10 amps / 250 Vac

90-783 NON-UL Ver SION.

$1\frac{9}{32}$ " long. Mounts in .59" hole
Rating 15 amps / 125 Vac



90-838 CB r EPLa CEMENT Ha r NESS

Fits many CB sets on the market today. Complete with color-coded wire, fuse holder and 2-Amp fuse and molded plug.



90-751 4-PUSH t Er MINa L CONNECT Or S

Push terminal 16 Ga wire connecting block. 2 red and 2 black push posts. Just a touch of the finger completes the circuit. Simple, yet positive action. Perfect for amplifier and speaker connections.

Size: $2\frac{11}{16}$ "(L) x $1\frac{15}{16}$ "(W) x $\frac{5}{8}$ "(D)
Mounting centers $2\frac{3}{8}$ "



90-732 HEa VY DUt Y INLINE f USE HOLDER

Heavy duty ATC/ATO* blade type fuse holder with 10 gauge wire. Length 8 inches.

* © ATC/ATO is a registered trademark of Little Fuse Company.

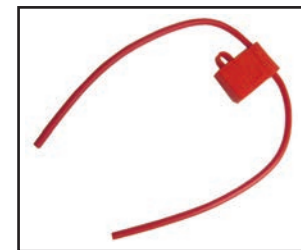

90-755 2-PUSH t Er MINa L CONNECT Or S

Push terminal 16 Ga wire connecting block. 1 red and 1 black push posts. Dimensions $2\frac{5}{16}$ "W x 1"H
Mounting Centers $1\frac{13}{16}$ "



CALRAD

90 Series - Speaker terminals & accessories

90-758

Banana Plug & Binding Post terminal Strip

gold terminals with plastic screw nut with red and black identification bands
Size: 2 1/8" (L) X 1 5/16" (W)



90-758G

All Gold Terminal Version
Dual Banana/Speaker Terminal Strip. Accepts either standard banana plugs or speaker wire up to 10 AWG. Solder, spade lug or screw rear terminal options available. Size: 2 1/8" (L) X 1 5/16" (W).



90-757

Banana Plug & Binding Post terminal Cup.

Gold terminals with plastic screw nut. Red and Black colored plastic nuts. Mounting Holes 2 1/2" Center to Center. Mounts in 2" Hole. Outside Face Dia. 2 7/8" Mounting hardware not included.



90-757G

All Gold Terminal Version Gold Plated Banana Plug & Binding Post terminal Cup

All gold terminals. Red and Black Identification bands. Mounts in 2" hole. Mounting holes 2 1/2" Center to Center. Outside Face Diameter 2 7/8". Mounting hardware not included.



90-756

PUSHBUTTON BINDING POST terminal CUP

Ideal for fast connections. Spring loaded. Just press and insert wires, release and wires are securely fastened. Installs easily into most speaker cabinets. Red and Black posts. Mounts in 2" hole, 2 5/16" dia. mounting centers.

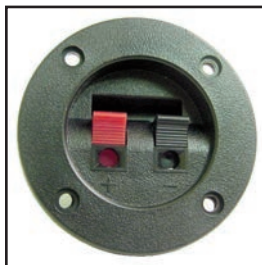

90-740

SPEAKER terminal CUP

2 1/4" x 2 1/4" square. Has spring loaded connectors. Red and black posts. Spade lug or solderable rear terminals
240 Vac @ 5 Amps.

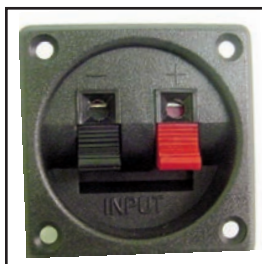

90-741

SPEAKER terminal CUP

2 1/2" x 3 1/8" size. Has spring loaded connectors. Red and black posts. Spade lug or solderable rear terminals.

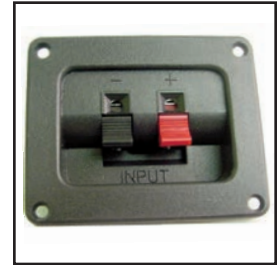

5-WAY BINDING POST S

Plastic insulation. Has 5/16" keyed threaded mounting shaft. Will mount in panels up to 1/4" thick. Colors shown below.

90-799.....Black
90-800.....Red



30-601 1 Red, 1 Black

30-601-BK 1 Black

30-601-r D 1 Red

Banana/Binding Post

Solderless speaker termination on each end Accepts banana style connectors or raw speaker cable up to 14AWG. Mounts in 3/8" hole.



30-601S-BK & r D

Gold plated binding post with push button on one end and banana jack on the other end. threaded barrel top screws off to accept 14 Ga wire.



Visit Calrad on the web at: www.calrad.com

90 Series - rubber feet, Chassis Boxes & tools

90-794

rubBER fEEt

Adhesive-backed molded bumpers apply instantly. Just peel off backing and apply to any dry, clean surface. 4 per pkg.
Size: 0.129"(H) x .520"(sq.)

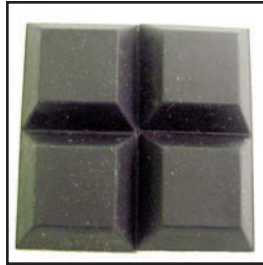

90-795

Same as 90-794 only larger.
Size: 0.300"(H) x .880"(sq.)

90-796

rubBER fEEt

Adhesive-backed molded bumpers apply instantly. Just peel off backing and apply to any dry, clean surface. 4 per pkg.
Size..... 0.400" Ht. x .880 dia.



90-797

rubBER fEEt

Adhesive-backed molded bumpers apply instantly. Just peel off backing and apply to any dry, clean surface. 4 per pkg.
Size0.320" Ht. x .635" dia.



90-819

HEaVY DUt Y a LUMINUM Ut ILIt Y BOX

Precision made. Ideal for mounting controls, intercom's and most transistor switching devices. Box wall thickness .085"
Size.... 4.65"(L) X 3.65"(W) X 1.36"(H)



HaNDY BOXES Wit H a LUMINUM PaNEL

Made of sturdy black ABS plastic, removable aluminum cover. Perfect for housing test equipment, experimental products.

90-784 ... 3 1/4"L x 2 1/8"W x 1 1/8"H

90-785 4"L x 2 1/8"W x 1 5/8"H

90-786 6 1/4"L x 3 3/4"W x 2"H



PLaSt IC Ut ILIt Y BOXES

Slotted for circuit boards. Grey sturdy ABS plastic.

90-8802 1/8"L x 4 1/8"W x 1 3/4"H

90-881 2 1/2"L x 5 1/8"W x 1 3/4"H

90-8823 1/2"L x 5 7/8"W x 2 1/2"H

90-8834 1/2"L x 7 3/8"W x 2 9/16"H

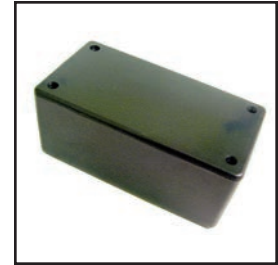

90-936

fLEXIBLE r at CHEt Dr IVEr SET

Comfortable ratchet wrench with flexible neck and ten inter-changeable tips. Flex neck is detachable. Bits: 3 slotted, 4 phillips, 3 torx.



90-937

17 PIECE Of f SET r at CHEt & SOCKEt Dr IVEr SET - Metric

Handy ratchet wrench with ten interchangeable tips or six sockets. Sockets are in fractions of an inch. Sockets: 5mm, 6mm, 6.5mm, 8mm, 9mm, 10mm. Bits: 3 slotted, 4 phillips, 3 torx.

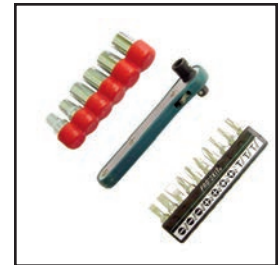

90-842

6-PIECE PHILLIPS SCr EWDr IVEr SET

Screwdrivers are made of hardened and tempered molybdenum steel. Black point blades are against reflection of light, swivel top is suitable for miniature work. Contains: 0.5-0.4-0.3-0.2-0-1.2 x 40mm



90-843

7-PIECE HEX BaLL Dr IVEr SET Wit H HaR DENED t IPS

Screwdrivers are made of hardened and tempered molybdenum steel. Black point blades are against reflection of light, swivel top is suitable for miniature work. Contains: 0.7-0.9-1.3-1.5-2.0-2.5-3.0 x 40mm



CALRAD

90 Series - Tools

90-844

7-PIECE COMBO SET

Screwdrivers are made of hardened and tempered molybdenum steel. Black point blades are against reflection of light, swivel top is suitable for miniature work. Contains: slotted; 1.4 - 2.0 - 2.4 - 3.0 x 40mm & phillips' 0.3 - 0.2 - 0 x 40mm



90-906

4-PIECE PRECISION TWEEZERS SET

Fine sharp point, curved tip, general point tip, and flat tip. Comes with carrying pouch.



90-828

3-PIECE LONG-HANDLE SCREWDRIVER SET

Screwdrivers are made of hardened and tempered molybdenum steel. Black point blades are against reflection of light, swivel top is suitable for miniature work. Contains: slotted; 2.4x75, 3.0x100. phillips; 0-2x7.



90-912

4 PIECE CERAMIC NON CONDUCTIVE TWEEZERS SET

Ideal for handling semiconductors, silicon chips and delicate wafers. Static dissipative and conductive ideal for use with sensitive components where ESD damage is a concern. Tweezers are manufactured with carbon loaded materials. 4 blade types: duck bill, wide duck bill, 60° fine tip, and straight fine tip. Heat resistant up to 180°C (250°F), Acid resistance. tips do not spread under pressure. No contamination and non magnetic. Overall length 4.75".



90-908

9-PIECE METRIC HEX KEYS SET WITH HOLDER

Sizes: 1.5mm, 2mm, 2.5mm, 3mm, 4mm, 5mm, 6mm, 8mm, 10mm.



90-927-8

90-927-12

BNC INSERTION AND REMOVAL TOOLS

Easy grip handle. Available in 8" and 12" shaft lengths.



90-930a

METRIC 7-PIECE FOLD-UP HEX KEY SET

Contains: 1/16", 5/64", 3/32", 1/8", 5/32", 3/16", 1/4". Finish: case painted in green lacquered finish. Key fingers sand blasted and then nickel plated.



90-928-8

COAX CABLE ASSEMBLY TOOL

This tool is used to remove 'F' connectors in tight areas. Also aids in the assembly of standard 'F' series connectors with a Female mounted connector to push against. also used to clear damaged or stripped threads.



90-905

5-PIECE NEEDLE FILE SET

5 style edges: flat, round, square, half-round, and triangle.

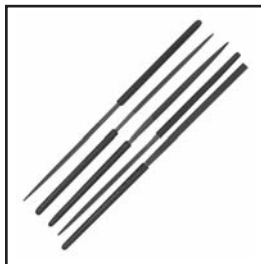

90-803

3 PIECE PRECISION ALIGNMENT TOOLS

Insulated handles with steel tips. Antistatic nylon construction.



CALRAD

90 Series - tools

90-804

10 PIECE PLASTIC ALIGNMENT TOOLS

4.5" long molded plastic rods with various types of tips: slotted, hexagon, and square. Easy grip handles.



90-925

SOLDERING IRON STAND WITH SPONGE

Works with Calrad soldering irons 90-921 and 90-923



90-850

MICROFLAT NOSE PLIER WITH INSULATED GRIP



90-900

TEMPERATURE CONTROLLED SOLDERING STATION

This electronic temperature control soldering station uses a sophisticated electronic circuit enabling the user to change the temperature from 300°F (150°C) to 900°F (480°C) without changing the tip or heating element. Temperature is maintained within ±10°F of its preset temperature by a unique temperature sensor located near the tip giving rapid response and little temperature variation. Soldering station has a digital readout.

90-900t Replacement tip for 90-900.

90-900r Soldering iron replacement.



90-853

MICRO LONG NOSE PLIER WITH INSULATED GRIP



90-926

60/40 ROSIN CORE SOLDER

370 degree melting point, 18 awg, 7 inch dispenser tube.



90-903

BUTANE GAS ORCHARD WITH MICRO HEAD

Comes with different tips for all styles of work. Unit is refillable. Five different tips are included.



90-805

CABLE SLITTING TOOL

Easy grip handle, adjustable cutting blade. Prepares cables up to 1.75". This tool can cut around or slit the length of the cable jacket.



90-923

C SOLDERING IRON

40 watt pencil style. 6' cord.



90-920

RATCHET CRIMPING TOOL

Designed to produce a solid and uniform crimp with every use. Crimps spade type connectors from .5-1mm², 1.5-2.5mm², 4.0-6mm². Handles cable sizes from 10 to 22 gauge wire. Comfortable plastic grip.



90-924

REPLACEMENT TIP

Replacement tip for 90-923.



90-921

C SOLDERING IRON

30 watt pencil style. 6' cord.



90-945

COAXIAL CABLE STRIPPER

This coaxial cable stripper will perform two level stripping of coaxial cables Stripping the outer jacket, braided shield and inner dielectric. The adjustable blade depth works well for different coaxial cable thicknesses.

RG-58/59/62/6/6QS/3C/4C/5C.



CALRAD

90 & 99 Series - tools, tape & Cigarette Lighter Plugs

90-856 PRECISION WORK HOLDER With 1.75" Magnifying Glass

Adjustable heads with 6 ball joints for all angles, locks at any angle. Alligator spring clips for easy use. Nickel plated fittings with heavy cast-iron base.



90-787 HIGH INSULATING ELECTRICAL TAPE

Plastic electrical tape consists of high dielectric strength and flexible stretch, snug wrap, waterproof. Will resist oil, gasoline, water, salt water, alkalis and sunlight. 3/4" wide, 60 ft. UL approved. **Please specify color when ordering**



90-787Black
90-787-BUBlue
90-787-GNGreen
90-787-WHWhite

Drill Bits

1/4"
99-f 12f 1/4" x 12" Flex Shaft
99-f 18f 1/4" x 18" Flex Shaft
99-f 24f 1/4" x 24" Flex Shaft
99-f 36f 1/4" x 36" Flex Shaft
99-f 58f 1/4" x 58" Flex Shaft
99-f 72f 1/4" x 72" Flex Shaft

1/2"
99-1218B 1/2" x 18" Stiff Shaft
99-1218C 1/2" x 18" Carbide Bit
99-1218f 1/2" x 18" Flex Shaft
99-1224f 1/2" x 24" Flex Shaft
99-1224B 1/2" x 24" Stiff Shaft
99-1236f 1/2" x 36" Flex Shaft
99-1236B 1/2" x 36" Stiff Shaft
99-1236C 1/2" x 36" Masonary Bit
99-1258f 1/2" x 58" Flex Shaft
99-1258B 1/2" x 58" Stiff Shaft
99-1272f 1/2" x 72" Flex Shaft

3/8"
99-3812B 3/8" x 12" Stiff Shaft
99-3812f 3/8" x 12" Flex Shaft
99-3818B 3/8" x 18" Stiff Shaft
99-3818C 3/8" x 18" Carbide Bit
99-3818f 3/8" x 18" Flex Shaft
99-3824f 3/8" x 24" Flex Shaft
99-3824B 3/8" x 24" Stiff Shaft
99-3824C 3/8" x 24" Carbide Bit
99-3836f 3/8" x 36" Flex Shaft
99-3836B 3/8" x 36" Stiff Shaft
99-3836C 3/8" x 36" Masonary Bit
99-3848B 3/8" x 48" Stiff Shaft
99-3858f 3/8" x 58" Flex Shaft
99-H3858f 3/8" x 58" Flex w/ extra hole
99-3872f 3/8" x 72" Flex Shaft

3/4"
99-7548B 3/4" x 48" Stiff Shaft

Auger Bits
99-a 10036B 1" x 36" Flex Shaft, Auger
99-a 10048B 1" x 48" Auger
99-a 1224B 1/2" x 24" Auger
99-a 1236B 1/2" x 36" Auger
99-a 1248B 1/2" x 48" Auger
99-a 3424B 3/4" x 24" Stiff Shaft, Auger
99-a 3436B 3/4" x 36" Auger
99-a 3448B 3/4" x 48" Auger
99-a 3472B 3/4" x 72" Auger
99-a 3824B 3/8" x 24" Auger
99-a 3836B 3/8" x 36" Auger
99-a 3848B 3/8" x 48" Auger
99-a 3872B 3/8" x 72" Auger
99-a 5836B 5/8" x 36" Auger
99-a 5848B 5/8" x 48" Auger



All drill bits have the hole at the end of the shaft for feeding wires thru the wall or window sill.

90-600 Cigarette Lighter Socket

Chassis mount version mounts in 7/8" diameter hole. Over all length: 2.64". 0.15" diameter post and 0.25" spade. Current rating 15A.

90-600-S
Same as the 90-600 except with a solderable center tab.



90-601 Cigarette Lighter Jack

Cigarette lighter jack for auto accessories. Rated up to 15 amps. Accepts up to .25" O.D. cable. Over all length: 2.7".



90-602 Power Cord Extension "Y" Adapter Cable

Enables two 12 volt units to be connected to one 12 volt battery pack or auto accessory outlet. Includes replaceable 3 amp fuse. Rated up to 15 Amps. 18 awg cable. Black cable.



90-604 Cigarette Lighter Plug

Snap-together case with single screw nut for fast easy replacement. Easy access solderless terminals. Single finger ground system. Accepts up to 18 awg cable. Over all length: 2.86". Spring loaded tip.



90 Series - Cigarette Lighter Plugs, Jacks & Cable assemblies

90-610

CIGAr Et t E LIghT Er PLUG

Snap-together case with single screw nut for fast easy replacement. Easy access solderless terminals. Single finger ground system. Accepts up to 16 awg cable. Over all length: 2.86". Spring loaded tip.



90-615

CIGAr Et t E LIghT Er PLUG

2-ear version for better ground connection. Easy grip handle for removal. O.D.: 0.25". Overall length: 3.7". Rubber strain relief. Color black. Spring loaded tip.



90-611

CIGAr Et t E LIghT Er PLUG

2-ear version for better ground connection. Fuse protected, complete with 5 amp fuse. Accepts up to .25" O.D. cable. Over all length: 3.3". Rubber strain relief. Color black.



90-616

r IGHt aNGLE CIGAr Et t E LIghT Er PLUG

Accepts 18-22 gauge wire. Fuse protected with a 2A fuse. 2 ear ground system and cable strain relief. O.D.: 0.25" Overall length: 2.7"



90-612

CIGAr Et t E LIghT Er PLUG

2-ear version for better ground connection, bakelite material. Accepts up to .25" O.D. cable. Over all length: 3". No fuse protection. Spring loaded tip.



90-617

CIGAr Et t E LIghT Er PLUG Wit H 20 a MP f USE

Heavy Duty cigarette plug with a 20 Amp fuse. Dual contacts and heavy duty spring.



90-613

CIGAr Et t E LIghT Er PLUG

Fuse protected, complete with 5 amp fuse. 2-ear version for better ground. Accepts up to .17" O.D. cable. Over all length: 3.7". Rubber strain relief. Color black. Spring loaded tip.



90-620

a DJUST a BLE CIGAr Et t E LIghT Er PLUG Wit H SWIt CH

Ratchet style cigarette lighter plug with built-in illuminated (L.E.D.) power switch. 10A fuse protected (fuse included). 2 finger ground system. 95° adjustable head. Accepts up to 16awg. cable.



90-614

CIGAr Et t E LIghT Er PLUG Wit H r ED L.E.D.

Same as 90-613 with LED for power indication. O.D.: 0.19" Overall length: 3.8". Rubber strain relief. Color black. Spring loaded tip.



90-606

CIGAr Et t E LIghT Er PLUG

Fits most automotive lighter sockets. 3 amp / 3 AG fuse. 18 awg zip cable - red/black. 16" leads and fused plug.



CALRAD

90 Series - Cigarette Lighter, Cable assemblies

90-605

**15 aMP CIGar Et t E
LIGHt Er PLUG Wit H
r Et r aCt aBLE Ca BLE**

Black, heavy duty 18 AWG coiled cable. Extends to 15 ft. Fits most automotive lighter sockets. Adds portability to your electronic equipment either inside or outside of vehicle. 3 amp fuse. rated up to 15 amps. Black cable. Stripped and tinned leads.



90-619

**CIGar Et t E LIGHt Er Ca BLE
Wit H 2.5mm COa X PLUG**

6' 20awg. black cable with 2.5mm Male coax plug to Male 5A fuse protected cigarette lighter plug with power indicator L.E.D. for use with all types of portable electronics requiring 12Vdc.



90-607

**CIGar Et t E LIGHt Er PLUG
Wit H Ca BLE**

Fits most automotive lighter sockets. 32" black 18awg. cable. No fuse protection.



45-820

LIGHt Er PLUG

Fused lighter plug with 6 detachable plugs. 12 ft. coiled cord with multi plugs on the other end. Fuse protected at 2 amps.



90-617-6

**CIGar Et t E LIGHt Er PLUG
Wit H 20 aMP f USE**

6' 16 awg. black cable with stripped and tinned ends. Heavy duty 20A fuse protected cigarette lighter plug with power indicator L.E.D. Dual ear contacts and heavy duty tip spring. For use with all types of portable electronics requiring 12Vdc.



45-821

LIGHt Er PLUG

Fused lighter plug with LED indicator. 6 ft. cord with 2.1 coax plug on the other end. Fuse protected at 5 amps. With positive center.



90-618

**CIGar Et t E LIGHt Er Ca BLE
Wit H 2.1mm COa X PLUG**

6' 20awg. black cable with 2.1mm Male coax plug to Male 5A fuse protected cigarette lighter plug with power indicator L.E.D. for use with all types of portable electronics requiring 12Vdc.



**90-618-r t r ight angle
Version on 2.1mm side only**



Visit Calrad on the web at: www.calrad.com

90 Series - Cable ties, Cable tie tools

Cable Tie Products

These tie products are manufactured of 100% non-corrosive, Type 6/6 Nylon. They meet MIL-S-23190, MS 3367, ASTM D4066-82, and are recognized under the component program of the Underwriter's Laboratories, Inc. (File No. E 37800). All products are Self-Extinguishing UL 94 Flam., Class: V-2. They are stocked in natural and weather-resistant, heat-stabilized black. Other colors are available upon request as noted on illustrations. The part numbers shown are for bulk-packaged, natural ties. Order other colors by adding color desired to part number shown. All cable ties sold in lots of 25, 100 or 1000.

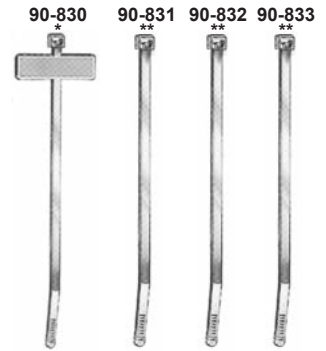

Part Number	Cross Section	Loop Tensile Strength		Minimum		Bundle Diameter		Military Standard	Overall Length	
				Minimum	Maximum	Minimum	Maximum		in.	(mm)
90-830 *	STD	18	(8.1)	3/16"	(4.7)	7/8	(22.2)	MS 3368-5	4.0	(101.6)
90-831 **	MIN	18	(8.1)	1/16"	(1.6)	7/8	(22.2)	MS3367-4	4.0	(101.6)
90-832 **	INT	40	(18.1)	1/16"	(1.6)	1 1/4	(31.7)	MS3367-5	5.5	(139.7)
90-833 **	STD	50	(22.7)	1/16"	(1.6)	1 3/4	(44.5)	MS3367-1	7.5	(190.5)
90-860 **	INT	40	(18.1)	1/16"	(1.6)	2 1/8	(53.9)	No App. Std	8.0	(203.2)
90-861 **	STD	50	(22.7)	1/16"	(1.6)	3	(76.2)	MS3367-7	11.0	(279.4)
90-862 **	STD	50	(22.7)	1/16"	(1.6)	4	(101.6)	MS3367-2	14.0	(381.0)

* Available in Natural.
 ** Available in Natural and Black.

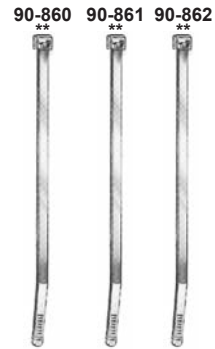

90-867a Cable Tie Installation Tool

Designed to combine maximum productivity and speed with operator comfort and safety. Simple to use - place tie around bundle and pull hand tight. Apply tool at head of tie and squeeze. Tie is pulled to pre-set tension and cut off in one simple operation. Adjustable, pre-set tension results in uniform cable tie application, neater bundles more efficient harnessing. Replacement cutting blades available for extended life. Short squeeze factor for greater comfort with less fatigue. Lightweight, only 12 ounces. Hand contoured handle. Positive positioning feature on tension adjustment knob.



90-868 Cable Tie Tension Tool



CALRAD

90 Series - Digital Calipers & Wire Conduit

90-913 0-100MM ELECT r ONIC DIGIt aL SILVER Ca LIPEr S

Measuring range: 0-75mm / 0-3", 0-100mm / 0-4", 0-150mm / 0-6", 0-200mm / 0-8", 0-300mm / 0-12". Resolution: + -0.01mm / 0.0005" Measuring system: Linear Capacitive, display LCD, Power 1.5 button cell. An ideal tool for a broad range of industrial and automotive applications.

features: Internal measuring jaw, locking screw, zero setting and power buttons, depth measuring blade, metric/inch change over, step measuring faces.



90-914 0-150MM ELECT r ONIC DIGIt aL BLa CK Ca LIPEr S

Measuring system: Linear Capacitive, display LCD, Power 1.5 button cell.

features: Internal measuring jaw, locking screw, zero setting and power button, depth measuring blade, metric/inch change over, step measuring faces, data output port, step measuring face. Tolerance, Hold, ABS selection. An ideal tool for a broad range of industrial and automotive applications.

features:

- Power: 2 x 1.5V SR44 (silver oxide cell) battery (included)
- Measuring range: 0–150 mm/ 0–6 inch.
- Accuracy: + 0.02 mm/ 0.001 in. (<100 mm), + 0.03 mm/ 0.001 in. (>100 -150 mm)
- Resolution: 0.01mm/ 0.0005 in.
- Zero setting in any position



SPLIT aND SOLID WIR E PVC CONDUIT

Split or Solid PVC, Corrugated Tubing Protects Wiring from Abrasion and sunlight. Organizes Wire and Eliminates Clutter. Split Allows for Easy Wire Insertion, While the Solid Insures Secure Blind Insertion.

1/2" to 1" Split Conduit

90-630-BK	100 ft. 1/2" Black
90-630-GY	100 ft. 1/2" Grey
90-631-BK	100 ft. 3/4" Black
90-631-GY	100 ft. 3/4" Grey
90-632-BK	50 ft. 1.0" Black
90-632-GY	50 ft. 1.0" Grey

Solid 2 Inch Conduit

90-635-BK	50 ft. 2.0" Black
90-635-BK-150	150 ft. 2.0" Black
90-635-GY-150	150 ft. 2.0" Grey

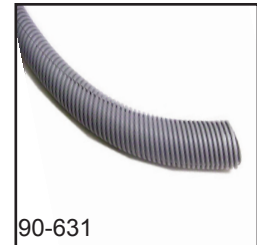

CALRAD

90 & 92 Series - L.E.D. Lighting

90-701-XLR - r a Pr O-a UDIO La MP WIt H 8 L.E.D LIGHT S

Perfect for mixing consoles or desk top, public address usage. Terminates to a male XLR connector. Over 50 year Avg. L.E.D lamp life. Material color: Black.

Specifications:

Power 8 L.E.D lamps operates on 12Vdc.
Current consumption250mA.
Gooseneck length.....12"
Wiring XLR Pin 1=ground, Pin 2=12Vdc
Material colorBlack



90-702 CIGa r Et t E LIGHT Er La MP WIt H 8 L.E.D. LIGHT S

For use in Car's or truck's. Provides a bright pure white light for reading. Never gets hot, easy to handle and operate. Terminates to a male cigarette lighter connector with ON/OFF switch. Over 50 year Avg. L.E.D lamp life.Fuse protected.

Specifications:

Power 8 L.E.D lamps operates on 12Vdc.
Current consumption250mA.
Gooseneck length.....12"
Material colorBlack



2-Wir E / 4 Wir E12VDC L.E.D. Str IP LIGHT ING

92-300 White 2-Wire LED Strip Lighting. 16 ft. rolls.

92-301 RGB 4-Wire LED Strip Lighting. 16 ft rolls.

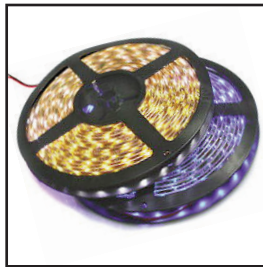

Mini LED f lashlights

- 92-203-BK.....Black
- 92-203-BU.....Blue
- 92-203-GY.....Grey
- 92-203-r D.....Red
- 92-203-WH.....White



Calrads new line of L.E.D. waterproof strip lighting provides the unique ability to select each independant color of Red, Green or Blue or combinations to create(256 shade levels each color, 16 million shades) of lighting in a small thin form factor. The flexible silicon PCB can be bent to a maximum radius of 2cm. 50 L.E.D's per meter 4 watts per meter. Cut between every 3 LEDs to create the size length for your application. Creates stunning visual effects, Little or no heat, Solid-state, high shock / vibration resistant, very bright & low power consumption. 16 ft. String requires a 12Vdc, 1.5 amp power supply.

92-200 6" a Vlat Or COMPa Ct f La SHLIGHT

Shock proof construction, heavy duty machined Aircraft Aluminium with high quality black anodized finish.

Fully adjustable focus head. All weather housing with sealed O-ring lamp and battery housing. One-handed tail rubber push button switch.

Shatter proof lense, includes spare bulb, belt style carring case with velcro flap and 2 x AA Batteries.



See page 103 for 12Vdc power supplies



92-340

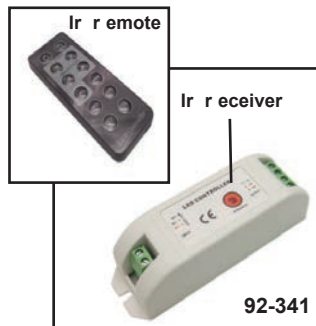

92-341

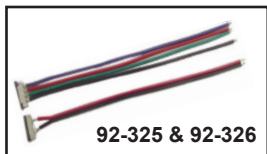

92-325 & 92-326

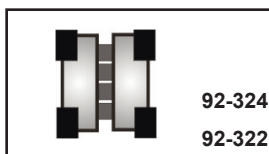

92-324
92-322

2-Wir E LED Str IP LIGHT ING

92-325 LED Strip Lighting Clips With 6" Leads

92-326 LEDStrip Lighting Clips With 6" Leads

92-340 r GB Manual Control Module

92-341 r GB Control Module and Ir r emote

92-322 2 Wire LED Strip Lighting Coupler

92-324 4 Wire LED Strip Lighting Coupler

92-201 COMPa Ct a Vlat Or f La SHLIGHT ON a 18" f FLEXIBLE GOOSENECK



92-201

90-1000 PER SONa L L.E.D Sa f Et Y LIGHT

With the mini-flash unit on at night, you will stay visible to motorists while walking or jogging on the road. Clip the mini -flash either on your hat or clothes.

Momentary push on/off power switch. Bright flashing red L.E.D. . Easy to replace 3V lithium battery CR2032.

90-1000-Ba t

3V lithium replacement battery CR2032.



CALRAD

92 series - L.E.D. Lights & Holders

92-111

RECESSED PANEL MOUNT HOLDER (BLACK) for 5 MM-Large LEDs

Fits into 5/16" hole with mounting hardware. LED not included. 9/8" depth overall.



92-110

PANEL MOUNT HOLDER (BLACK) for 5 MM-Large LEDs

Fits into 5/16" hole with mounting hardware. LED not included. 9/8" depth overall.



92-115 (red)

92-116 (Green)

PANEL MOUNT SELF FLASHING LED'S

Fits into 5/16" hole with mounting hardware. 36" leads, 5-15V DC, Current draw 20-30ma.



FLASHING LED'S 5 MM SERIES—Large

Apply voltage and they turn on and off. Note: Plastic Snap-Type Holders available above for 5 mm LED's.

92-100Red, Color diffused 92-102Amber, Color diffused
 92-101Green, Color diffused 92-103Yellow, Color diffused

Specifications

- a. This diameter is measured 0.05 (0.002) from shoulder.
- b. The contour is not controlled within this region of the leads.
- c. Lead spacing is measured where the leads emerge from the package—2.29 ±0.13 (0.090 ±0.005)
- d. All dimensions are in millimeters (inches).

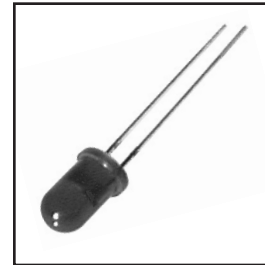

- 92-120-BL, BLUE L.E.D.
- 92-120-GN, GREEN L.E.D.
- 92-120-RD, RED L.E.D.
- 92-120-WH, WHITE L.E.D.
- 92-120-YL, YELLOW L.E.D.

5mm Water Clear Super Bright L.E.D'S

These L.E.D'S provide pure high power illumination. Their high performance and long life properties make them perfect for use as solid state panel indicators and lighting applications, illumination emitters for all types of new display technologies. Available in five different colors. Detailed specifications available from Calrad, ask your sales representative for information.



92-125 HEADBAND L.E.D. FLASHLIGHT

Contains 7 high intensity LEDs to make your environment ultra bright wherever you are. The headstrap on the headlight is fully adjustable, featuring an adjustable incline for customization. Requires 3 AAA batteries. Typical battery life is around 80 hours, while the LED last 100,000 hours. The headlight is a water resistant design, making it fully usable under any condition you're in.



92 Series - Ir Distribution

92-160 Ir DISTRIBUTION SYSTEM

IR Connecting hub with a wired receiver that terminates to a 3.5mm stereo plug. A terminal block is also provided to support wired type receiver connections if needed. Designed to simplify the connection of IR receivers and emitters for IR signal distribution. The 92-160 has the ability to send IR signals to 6 sources using a single emitter or 12 or more sources if double or triple IR emitters are used. Three colored LED indicators show power status, IR signal and IR confirmation. Comes with one receiver and one emitter, 12 VDC supply.



92-160

92-167 6 Port Ir CONNECTING BLOCK

IR connecting block supports wired type IR receiver connections and 3.5mm IR emitters for IR signal distribution.



92-167



92-169

92-169 2 Port Ir Repeater Kit

Compact 2 port IR repeater kit provides a simple system to control equipment located in a closet, equipment rack, or behind you, or even in another room. This kit requires a IR receiver, use Calrad 92-164 keystone IR receiver or 92-165 surface mount IR receiver, (Not Included) and single or double IR emitters, 92-152 (Single Emitter), 92-152-2 (Double Emitter), (Not Included).



92-152-2



92-165

92-152

Single Ir flashing Emitter, 6 ft. cord

92-152-2

Dual Ir flashing Emitter, 6 ft. cord

92-153

Triple Ir Emitter array 6 ft. cord

92-165

Ir receiver 6 ft. cord



92-153



92-163



92-164

92-161 Ir Distribution System

92-166 In Wall Ir receiver Plate

Same as 92-160 but with flush mount wall receiver.

Specifications

- Includes 1 distribution block, 1 flush mt. receiver, IR emitter.
- Includes 12 Vdc 300ma power supply.
- DC Power Supply positive center.
- 6 3.5 mm Mono IR emitter outputs.
- 1 Detachable, 4 conductor IR receiver input connector
- 2 3.5mm Stereo Jack IR Receiver input
- Dimensions, IR Receiver: L-2.13", W-.56", H-.52"
- Dimensions, Distribution Block: L-1.95", W-2.25", H-.95"
- Distribution Block weight: 6 oz.
- Power supply input 120 VAC 60 HrZ
- Power supply output 12VDC Positive Center



92-161



92-166

92-163

3.5mm Stereo Jack In a Keystone Insert

Features 3 position spring terminals for IR Emitters or Stereo Audio. Accepts up to 22ga. solid wire. Color: White.

92-164

Ir receiver In a Keystone Insert In a Keystone Insert

Features 3 position spring terminals, V+, V-, signal. Frequency: up to 47KHz, Voltage 9-12Vdc, Current draw: 22mA, receiver max distance 30 feet, IR receiving offset: 120°. Accepts up to 22ga. solid wire. Red LED provides clear indication of Signal reception. Color: White.

CALRAD

92 series - Ir Distribution

92-170-Kit Ir Distribution Over Coax Injector-Coupler System

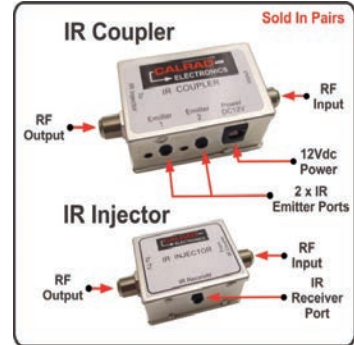

The 92-170 IR injector and coupler system sends remote control signals to your satellite dish, cable box, or DVD using a standard IR remote, even if the component you wish to control is located in another room. The Calrad RF/IR Injector delivers your IR signals over a single coaxial cable up to 300 feet to the actual component. Attach Calrad's IR 92-165 receiver using the 3.5mm stereo mini plug to the RF/IR Injector, which attaches to your coax cable between the satellite or cable input and the television you'll be watching. The IR Signal Coax Cable Coupler extracts the IR commands on the other end and delivers them to the satellite dish or other component via a Calrad's 92-152 IR emitter. The IR Coupler/Injector are sold in pairs and the 1 x 92-165 IR receiver, 2 x 92-152 IR emitters, 1 x 12-Volt DC Power Supply are included. There are several ways to use the 92-170 system, using coax only for the IR signal itself or with a CATV service or RF modulated system on the coax cable at the same time. A Calrad DC blocker, (75-726) if required if a splitter is used between the IR Injector and coupler.

Specifications:

- IR Receive, Transmit Frequency Range..... 34 khz - 60 khz
- Maximum Coax Cable Distance..... 300 ft.
- IR Injector Size: L-1.9" x W-1.42" x H-.835"
- IR Injector Connectors: 2 x F81 RF Jacks, 1 x 3.5mm Jack
- IR Coupler Size: L-2.2" x W-1.4" x H- 1.0"
- IR Coupler Connectors: 2 x F81 RF Jacks, 2 x 3.5mm Jacks, 1 x 2.1 Coax 12Vdc Power Jack.
- 12Vdc Power Supply, Included
- Shielded Chassis Design

75-726 75 Ohm DC BLOCKER

5-1750MHz, insertion loss 0.3dB, return loss 16dB typical. Nickel plated machined brass. Passes RF and blocks DC from the signal path. Male 'F' connector to F-81 style female. Overall length 1.6".

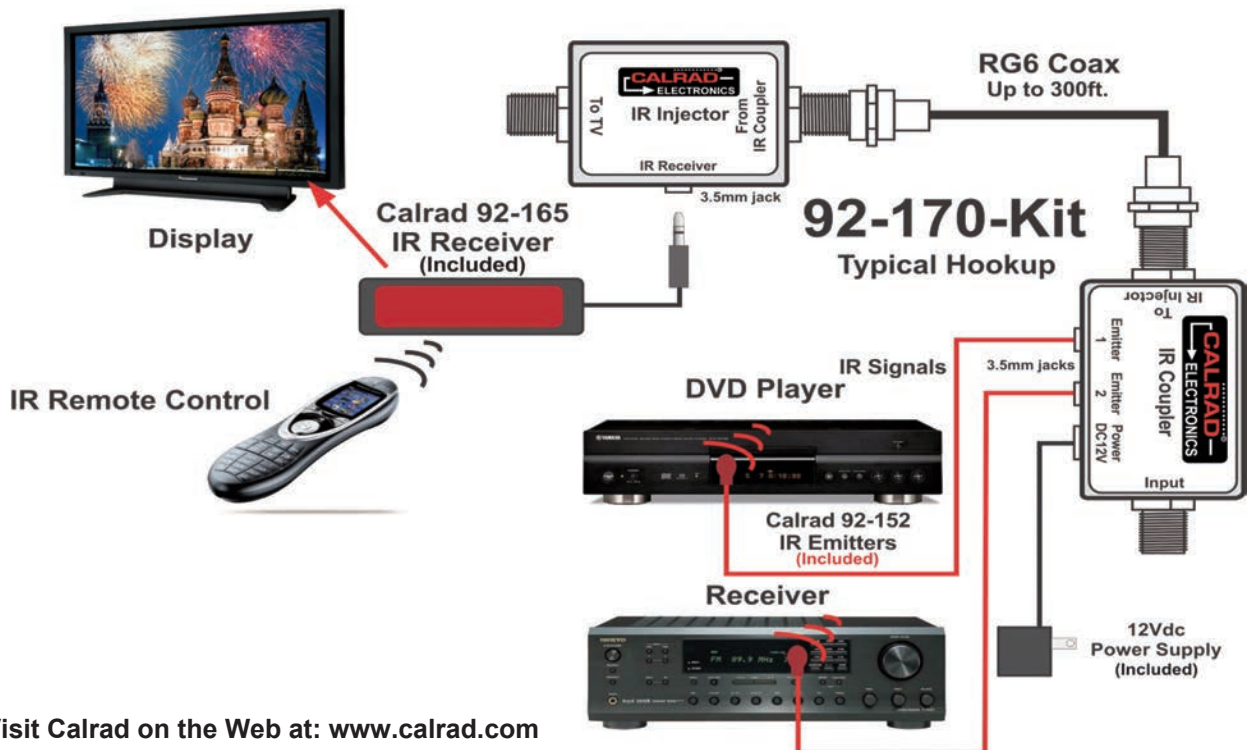

CALRAD

95 Series - alarms & Keypads

95-600 6 ZONE aLar M SYSt EM Wit H L.E.D. KEYPaD
95-800 8 ZONE aLar M SYSt EM Wit H L.E.D. KEYPaD

Burglar and Fire Alarm control panels are ideal for light residential and commercial use. The small keypad with its large, illuminated tactile buttons make entering commands easy in low lighting conditions. Removable front door on control panel for easy wiring and access. Built-in power supply and digital communicator. Unit comes with (1) control panel, (1) L.E.D. digital keypad, (1) AC power transformer. Can use up to seven (95-602) alpha-numeric keypads and four (95-601) L.E.D. keypads. All options are fully programmable thru the digital keypad. Programmable entry, exit, siren delay times. UL Compliance Alarm Panel.

Specifications

Power Requirements 16Vac, 40VA Transformer Supplied
 Battery Backup terminals provided for a 12V battery, rechargeable gel type, not supplied (Calrad part # 95-894)
 Regulated Switched Auxiliary Power Supply 500mA - 800mA max, with all devices.
 Siren Output: Current 2 Amps
 Zones Normally Closed and Normally Open
 System Capacity 7 alpha-numeric keypads and 4 L.E.D. keypads
 Transient & Lightning Protection Yes
 Wiring Knockouts 3/4"
 Cabinet Lock Knockout provided
 Dimensions 11"(H) x 11"(W) x 3 1/2"(D)
 Weight 4 lbs.



Easy Access
Barrier Terminal Strip

95-601 L.E.D. KEYPaD

Used with the Calrad 95-600 6 zone alarm system. 3 wire hookup. LED keypad size: 6 1/2"(W) x 4 1/2"(H) x 1 1/4"(D).



95-602 L.C.D. KEYPaD

Used with the Calrad 95-600 6 zone alarm system. 3 wire hookup. LCD keypad size: 6 1/2" (W) x 4 1/2"(H) x 1 1/4"(D).



95-801 L.E.D. KEYPaD

Used with the Calrad 95-800 8 zone alarm system. 3 wire hookup. LED keypad size: 6 1/2"(W) x 4 1/2"(H) x 1 1/4"(D).



95-802 L.C.D. KEYPaD

Used with the Calrad 95-800 8 zone alarm system. 3 wire hookup. LCD keypad size: 6 1/2"(W) x 4 1/2"(H) x 1 1/4"(D).



95-1601 L.E.D. KEYPaD

16 zone L.E.D. keypad 55-130mA nominal current draw. 3 wire hookup. Size: 6.5"(W) x 4"(H) x 1.3"(D)



95-470 SMOKE DET ECt Or

Self diagnostic 4 wire photoelectric smoke detector with heat sensor, 12/24Vdc. Perfect for home or commercial use. Works with all Calrad 95-600, 95-800 series security panels. Alarm Current draw [Nominal] 15.0 mA. Size: Diameter 6.1", Depth 1.85". Approvals, UL 268, ULC, FM, CSFM, MEA.



CALRAD

95 Series - A/V Baluns & Security Accessories

95-1040 RCA Composite Version 95-1045 SVHS Version

AUDIO & VIDEO BALUN CAT-5

CABLE SySTEm

Transmit stereo audio and composite video up to 1000 ft using CAT-5e cable. The advantages of the system are: clear video signal, fewer cables to manage, lower cost per connection, centralized wiring for greater control. Video bandwidth 12MHz, Audio 20Hz-15KHz. Two units required for transmission and reception of balanced signals. Size: 2.2" (W) x 1" (H) x 3.5" (D).



95-1038 CCTV BALUN + POWER

Transmit video and power over one CAT 5 networking cable. Include 2 units: 1 x RJ45 to BNC with DC power plug, 1 x RJ45 to BNC with DC power jack.

95-1039 CCTV BALUN + POWER, DATA

Transmit video, power and RS422 or RS485 Data over one standard CAT 5 cable.



95-1044-BNC BNC RGB

95-1044-RCA RCA Component RGB/COMPONENT VIDEO BALUN CAT-5 CABLE SySTEm

Video (RGB) balun is designed to transmit Red, Green and Blue (RGB) video signals over CAT-5 UTP cable. Unit has an internal impedance matching device and filter for video signal transmission over UTP cable up to 1000 ft. Use your existing CAT-5 wiring for all new video installation. Color: black. Size: 2.2" (W) x 3.5" (L) x 1" (H).

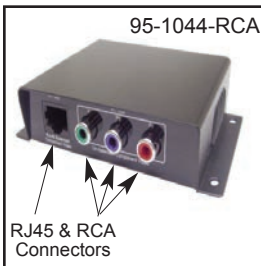

See page 56 for etailed specifications

95-464 DUAL GLASS BREAK DETECTOR

This sensor is used to protect areas which conventional sensors that have to be attached to each window, but this unit covers a specific area and uses a dual sensing technology to protect a larger area. The flex audio technology is sensitive to different frequencies. Ultra low end types generated by hard sharp blows to glass windows. The unit remains off until flex technology detects a blow to the glass. For an alarm condition to occur the audio must first detect the frequency of breaking glass within a defined time window. After the flex detects a blow to the glass, because both technologies must detect and verify glass breakage, false alarms are virtually eliminated. Indicator LED's provide visual indicators for various functions. Operates on 12Vdc.



40-1010 VGA OVER CAT5E BALUN

Transmit a VGA signal up to 580 ft over Cat 5e. Supports PC resolutions up to 1280X1024. HDDB 15 Female input and output. Transmitter and receiver requires power. 12Vdc power supplies included. Sold as a transmitter and receiver set. Transmitter, Receiver Size: Length 3.76" x Width 1.3" x Height 1.2".



95-455 INFRARED & MICROWAVE MOTION DETECTOR

Our most advanced motion detector using an infrared sensor to pickup thermal energy and a microwave detector to detect physical motion. This detector incorporates a new sensing circuit to process both technologies to provide a reliable triggering sensor for security systems. Features Microwave/PIR technology, single edge PIR triggering and L.E.D. indicators for IR detection, microwave detection, and alarm triggering. Operates from 6-15Vdc, current draw 35mA. N/C dry contacts 28Vdc, 125mA. Protection coverage 35' long x 35' wide. Color: white.



95-1046 Composite Video, S-Video, Analog or Digital Audio Balun

Passive RCA Audio/Video balun. Transmit stereo audio, digital audio, composite video or S-Video over A single Cat 5/Cat 6 UTP cable up to 1000 feet. Transmission of S-Video requires the Calrad 55-741 cable. Transmission Distance: Stereo audio 2500 Feet max, Digital audio 1000 feet. Dimensions:(L) 2.4" X (W) 1.69" X (H) 865".



95-960 TWIN PHOTOBEM DETECTORS

Fixed dual beam infrared pulsed perimeter detectors. Range 320' indoors, 160' outdoors. Excellent immunity to freezing, snow, rain, fog, and other bad weather conditions. Antifrost design, operates with frost or dew without false alarms. Interruption time adjustable for nearly all situations. N/C tamper switch included. Power input 10-24Vdc.



95-1041 VIDEO BALUN CAT-5

CABLE SySTEm

Balanced video RJ45 to unbalanced Male BNC adapter. Transmit a color video signal up to 1000' using industry CAT-5 networking cables with RJ45 connectors. Includes CAT 5 RJ45 male to 2 screw terminal adapter. The advantages of this type of system are clear video signal, fewer cables to manage, lower cost per connection, centralized wiring for greater control. Video bandwidth 12MHz. Two units required for transmission and reception of balanced signals. Size: .76"(W) x .9"(H) x 2"(D).



95-460 iR SENSOR WITH PULSE COUNT

Small compact infrared sensor is perfect for all applications commercial or residential. Stable circuitry for reliable operation. Optional brackets for multi-angle mounting on ceilings or walls. Available in form C relay for normally open, normally closed applications. Tamper switch provided, 35' x 35' coverage. Operates on 12Vdc.



95 Series - Security Accessories

95-920

WINDOW BUG SENSOR

Dry circuit, no power required. Protects up to 32 square feet. Adjustable operation for N/O, N/C circuit. Automatic reset. Peel and stick mounting. Available in white and gray. Provides good visible deterrent.

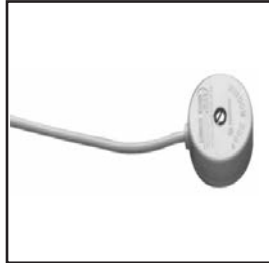

95-906 PRESSURE SECURITY MAT

Designed to give faultless service, extra thin, made of black PVC plastic, can be placed under existing rugs, mats, etc. Copper bus is used to connect each segment together and is timed for long use. Size: 29"W x 21"L. Normally open.



95-898 BURGLAR

ALARM MODULE

Versatile, low cost, solid-state control module with full relay power output. Excellent protection for the home, office, apartments, condominiums, etc. Easy to install. Features closed and open circuit loops. Built-in 3 to 11 minute adjustment reset timer. Will automatically reset if protective loop has been closed. The loops may be armed or disarmed anytime by a key switch. Operates on 6-12 Vdc.

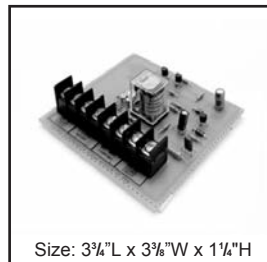

Size: 3 3/4" L x 3 3/8" W x 1 1/4" H

95-899 DELUXE ALARM

CONTROL MODULE

Same specifications as the 95-898, but with the added feature of entry/exit time delay circuit. Built-in 3-10 min, adjustable reset timer and sound alert entry reminder. Entry delay loop can be adjusted from 15 to 60 sec. Exit delay is preset at 60 seconds. This entry time delay circuit saves the cost of an outside shunt switch. Also adds to your protection of inside control switching with added nighttime protection while at home. Operates on 6-12 Vdc.

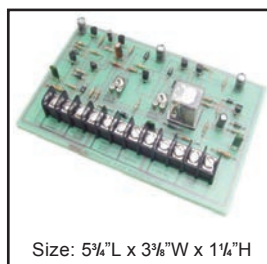

Size: 5 3/4" L x 3 3/8" W x 1 1/4" H

95-914 ELECTRONIC LATCHING RELAY

Momentary input, latching output. Converts old style shunt panel to new multi-key system. Use to shunt an interior loop. Use as a lock-out on commercial systems. Programmable 6/12/24Vdc, SPDT relay with two (2) LED indicator outputs.

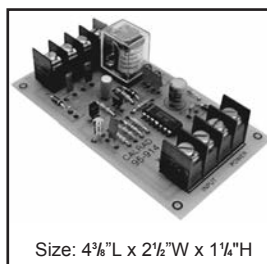

Size: 4 3/4" L x 2 1/2" W x 1 1/4" H



95-405 INFRARED DOOR ANNOUNCER

This door announcing device emits a continuous, invisible infrared beam to the reflector and returns it to the receiver. When this beam is interrupted it will announce the entrance of the customer by a pleasant chime or alarm sound (via selector switch). Single-ended detection technology eliminates the need for a separate transmitter and receiver. An alignment LED is provided for fast and easy installation. Features: All parts included for easy, complete installation. Maximum detection range of 35 feet. Two-chime maximum hook-up. On-Off switch in-line. U.L. Listed transformer provided. 35 foot length of AWG #22 wire provided. Operating voltage of 6 Vdc. Current consumption of 70 mA armed, 1.2 amps alarmed.

95-405-C (EXTRA CHIME SOLD SEPARATELY)

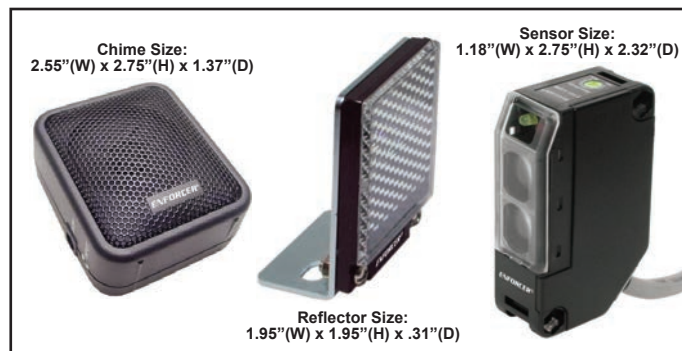

Chime Size:
2.55"(W) x 2.75"(H) x 1.37"(D)

Sensor Size:
1.18"(W) x 2.75"(H) x 2.32"(D)

Reflector Size:
1.95"(W) x 1.95"(H) x .31"(D)

95-403 RETRO-REFLECTIVE PHOTOELECTRIC IR SENSOR ENTRY ALERT SYSTEM

This unit is perfect for monitoring an entrance or use as an entrance indicator. Uses Retro-reflective photoelectric sensor. When beam is interrupted a "ding-dong" sound or optional siren sound will occur. Speaker volume can be adjusted or turned off. When in siren mode, sounding time is adjustable from 3 to 30 seconds. Range is up to 22 feet or 7 meters. 9Vdc power adapter is included. All components plug into each other so no hard wiring is needed.

includes the following:

- 1 Retro-reflective photoelectric sensor
- 1 Reflector
- 1 Speaker/electronic chime
- 1 9Vdc power adapter

Hardware included:

Mounting brackets X 3, Screws X 7, Drywall Anchor X 1

Specifications:

Sensing Range:22feet
Voltage Supply:.....Sensor = 9-15Vdc
Chime = 12Vdc

Total Current Consumption:100mA Max.

Standby Current:25mA

Light Source:IR LED

Control Output:NPN open collector

.....(DC 30V, 100mA Max.)

Speaker Response Time:.....~1 sec. for chime

.....30 sec. for alarm

Alarm Time Range:.....Adjustable 3-30sec. for alarm

Speaker Output:..Chime/Off/Alarm (Select by switch)

CALRAD

95 Series - Security System Timers & modules

Detailed specifications are available for these products upon request.

95-840 LOW CURRENT RELAY MODULE

This unit switches a set of dry contacts DPDT rated at 5 amps @250Vac, 30Vdc. Supply Voltage, programmable 6/12/24Vdc. Current draw, 70mA when relay is active Minimum pull voltage +/- 20% of operating voltage. LED power indicator. Mounts with foam tape.

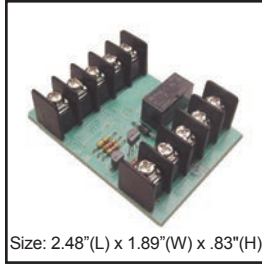

Size: 2.48"(L) x 1.89"(W) x .83"(H)

95-904 24-HOUR PANIC & FIRE CONTROL MODULE

By adding this module to either the Calrad 95-898, 95-899 alarms, or any other standard control center, you can have a 24-hour panic override switching circuit, even though your alarm is on or off. When triggered, this control will activate either the alarm bell, siren or another independent alarm device. May also be used for non-supervised open circuit heat detection.

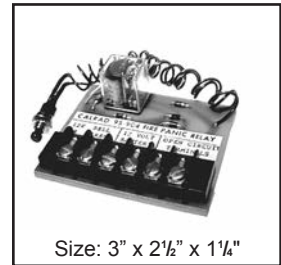

Size: 3" x 2 1/2" x 1 1/4"

95-847B UNIVERSAL TIMER

This unit can be used for many applications such as a dialer trip delay, bell shutdown timer or exit delay. Features: 1 Sec to 15 Min. adjustable. Relay output (N/C/NO). Low power drain. Transient protected. Voltage reversal protected. Auto reset. Totally enclosed package, small size.

Specifications

Input Voltage.....	11 to 13 Vdc	Operating Temperature.....	32° to 100° F.
Program Time.....	1 Sec to 15 Min.	Dimensions.....	1.6" (L) x 2"(W) x 1.5"(H)
Operating Current (Relay activated).....	.040 amp.	Mounting Area.....	3.6 sq. in.
Operating Current (Relay de-activated).....	.010 amp.	Weight.....	0.15 lbs.
Relay Contact Rating - Voltage.....	50 V ac/dc	Relay Contact Rating - Current.....	2 amps



95-849 miNi Timer MODULE

Low-Voltage Miniature Delay Timer Module for Access Control and Security Applications. The 95-849 is a low-voltage miniature delay timer module which operates on 12 to 24 volts AC or DC. This timer module will extend the activation time of a momentary contact switch for 1~60 seconds via a field-adjustable rotary pot. It is ideal for electrical locks which do not have a built-in time delay function. Its compact size makes it small enough to fit in a single-gang box or inside a door frame cavity. The 95-849 timer module is easy to install and useful in both commercial and home security applications. Specification: Adjustable timer from 1~60 seconds via a pot on board, N.O./N.C. switch trigger. Compact design: 1.2" X 2.16" X 0.62" (30 x 55 x 16 mm), operating voltage: 12~24 volts AC or DC, Current: 1.8mA (stand-by), 75mA (active). Relay output: Form-C (SPDT) via wires Contact rating: 3 Amps @ 24VDC, built-in beeper output (150mA @ 24VDC), Includes double-sided foam tape.

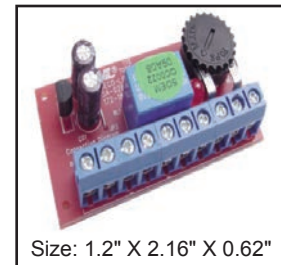

Size: 1.2" X 2.16" X 0.62"

95-724A DIGITAL ONE CHANNEL ANNUAL EVENT TIMERS

Highly versatile 24 hour, 365 day, event timer. Designed to support a wide range of applications. Such applications include: Home and Building Automation, Security, Access Control etc. Equipped with form "C" relay contacts that provide many latching and/or momentary operations during a program schedule of your choice. The EE prom memory allows for programming of unit prior to/or during field installation. Events may be set for single or multiple operations on a daily and/or weekly schedule. The block programming feature enables repeating an event on any combination of consecutive days. 95-724A will compensate for daylight savings time if desired. It automatically adjusts for leap year and is Y2K compatible. Individually selected holiday exceptions can be programmed to over-ride regularly scheduled events.

Specifications:

- 12 to 24 volts AC or DC operation
- Standby current: 10mA (relay off) 50mA (relay on)
- Battery charging current: 100mA
- Form "C" relay contacts are rated 10amp @ 120Vac/28Vdc
- EE Prom memory protects against loss of programming due to power failure
- Accurate crystal controlled clock
- Momentary and/or latching events
- 50 Individually programmed daily/weekly events
- Block programming capacity can accommodate a total of 350 events per week
- 10 programmable holiday dates
- "First man in" option
- Alphanumeric LCD display simplifies programming
- Standard or daylight savings time settings
- Automatic compensation for leap year
- Built-in charger for 12Vdc sealed lead acid or gel type batteries (max charge current 100mA)
- Lithium battery backup maintains clock (optional)
- User friendly programming
- Board dimensions: 5.25" (W) x 3" (L) x 1" (D)

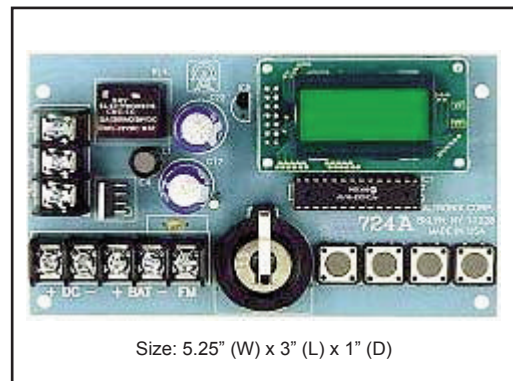

Size: 5.25" (W) x 3" (L) x 1" (D)

CALRAD

95 Series - Security Accessories

Detailed specifications are available for these products upon request.

95-848 DIGITAL

CUT-OFF TIMER

This unit can turn off a ringing bell or siren, can be used as a N/C, N/O delay relay for use as a dry contact switch to delay or remove a contact closure. Requires 6-12 Vdc to operate.

Specifications

Relay Contacts.....3 Amp Max.
Current Drain.....25 mA
Adjustable Relay Time 1 sec-10 min.

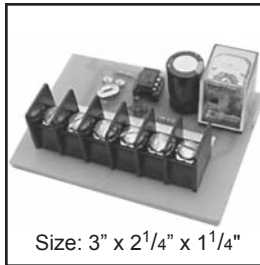

Size: 3" x 2 1/4" x 1 1/4"

95-894 12 VOLT, 7 AMP

BATTERY

Lead-acid, sealed rechargeable battery. Replacement battery for Calrad 95-893 power supply. Weight: 5.8 lbs. Size: 6"(W) x 2.5"(D) x 3.5"(H).



95-845 MULTIMODE PRECISION

DIGITAL TIMER

Digital timer .01 seconds to 2550 hours (106 days). Operates at 10-15Vdc. Dry contact relay output, N/O, N/C @ 2A. Select timing modes by dipswitch. Multiple timing operations. Delay on break, delay on make, single shot interval timer, ON/OFF recycle.

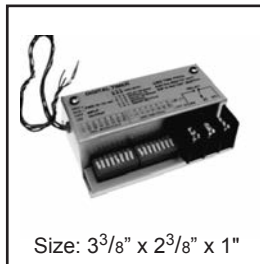

Size: 3 3/8" x 2 3/8" x 1"

95-908 STAINLESS STEEL

REMOTE KEY STATION

Remote key station single gang plate, features key switch, circuit test button and red, green indicator, LED lights to be used with 95-898 or 95-899 alarm modules.



95-846 DIGITAL TIMER

For use with security & gate entry systems, or can be used to control a set of dry contacts with a momentary positive or negative trigger. Time is adjustable from 2-45 sec. Works with AC or DC power. Built-in LED power indicator.

Specifications

Operating voltage 12-24 Vac, Vdc
Current consumption relay triggered 30 mA
Dry contact rating..... 3 amps

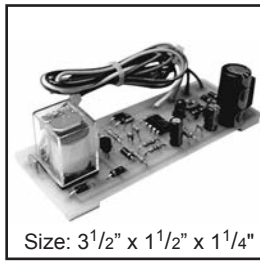

Size: 3 1/2" x 1 1/2" x 1 1/4"

95-909 SINGLE GANG

STAINLESS STEEL

Single gang plate with .75" "D" hole and red, green LED's, 6 Vdc or 12 Vdc operation. Use with Calrad 40-663HS, 40-682, or 40-683 key switches.



95-923 PROGRAMMABLE TIMER

Perfect for use with a variety of timed security and access control operations such as door unlock timing, siren, bell timer or VCR/DVD timer. Auto-sensing of input voltage and DIP switches for programming make for easy installation. Time adjustable from 1 second to 60 minutes. AC/DC usage.

Specifications

Operating voltage 12- 24 Vdc
Current consumption relay triggered 50 mA
Dry contact rating 8 amps
Energized50 mA
Stand by.....1 mA

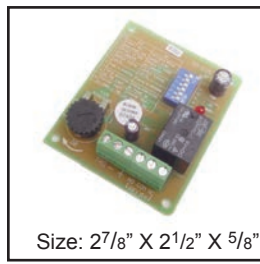

Size: 2 7/8" X 2 1/2" X 5/8"

95-821 DOOR/GATE ACCESS

DIGITAL KEY PAD

Indoor digital keypad for door entry and gate access. Stainless steel face plate. Operating voltage 12-14VDC. Current consumption 10-60mA. Relay output 5A at 30Vdc, dry contact. Over 111 million code combinations. Fits in a single gang opening. Color: stainless steel finish.



95-893 POWER SUPPLY 12 VDC, 7 AMP HR.

Complete with charger board, 16Vac plug-in transformer, 12Vdc LEAD-ACID Rechargeable Battery. Fuse Protected. Automatic Full Charge Shutdown. Voltage Reference Indicator. 12 Volt, 7.8 amp hour battery available separately.

45-759 1.2 amp REGULATED CHARGER BOARD ONLY

16Vac in, 12Vdc out. Fuse protected.



Battery size:
6"(W) x 2.5"(D) x 3.5"(H)

Board size: 3.5" x 3"

95-820 WATER RESISTANT

DIGITAL KEYPAD

Water resistant digital keypad for door and gate access. Operates on 12Vdc. Dual output dry contact relays. 2A at 18Vdc, 1A at 120Vac. Tamper proof switch. EEPROM memory, audible key beep. 1 million possible codes. Color: white. Size: 4.6"(L) x 2.9"(W) x .9"(D).



Visit Calrad on the web at: www.calrad.com

CALRAD

95 Series - Security Accessories

95-823 TRIPLE LATCHING DOOR/GATE ACCESS

DiGiTAL Key PAD

Indoor digital keypad for door entry and gate access. Stainless steel face plate. Operating voltage 12-14VDC. Triple latching relays.



20-312 SiREN HORN

Same unit as 20-310 except features built-in siren amplifier. 30 Watts, Operates on 6-12 Vdc, our most powerful siren horn, has wiring for both steady and yelp siren operation. 120 dB at 6ft. Horn Dimensions: 4³/₄" x 8" x 9¹/₄" (deep), Color: white.



95-824 Heavy Duty Sealed Environment Surface mount Weatherproof Self Contained Access Control Key pad

IEI 232SE Sealed Environment Surface Mounted Weatherproof Stand Alone Access Control / Door Shunt / Timered Flush Mounted Keypad with Expanded Programming Features. Code flexibility: Codes can be 4-8 digits.

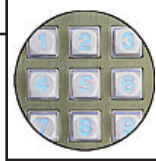

Illuminated Buttons

6 / 8 / 10 INCH BELLS

Produces loud clear ring, will overcome most high background noises. UL approved.

95-882 6 inch, 12 Vdc, 82 dB, .06 amps

95-884 6 inch, 24 Vdc, 82 dB, .06 amps

95-888 8 inch, 12 Vdc, 85 dB, .06 amps

95-911 10 inch, 12 Vdc, 85 dB, .06 amps



95-950 RF REMOTE CONTROL SySTEm

3 channel RF transmitter and receiver system with dry contact relay switching. Receiver requires 12Vdc. Channel 1 & 2 uses 2 amp relays, channel 3 provides neg. transistor output 500mA. 100'-150' range Used for garage door/gate access or interface with Calrad home/commercial security systems. Code encryption with over 1 million code combinations. Operates on 303MHz.



95-900 ELECTRONIC DUAL BEEPER HORN

Produces penetrating continuous or pulsating tone. Will operate on either 6 or 12 Vdc. Used in many alarm warning devices. Small in size, mounts into 1¹/₈" hole. Color: black. Size: 1"(H) x 1.5" (dia).



95-850 ELECTRONIC DOOR RELEASE UNIT

Operates on 10-14Vdc. Current draw 800mA. DC coil resistance 14 ohms. Comes with mounting screws. Mounting plate 6.25" x .99". Coil body 3.5"(H) x 8"(W) x 1.1"(H). Overall depth 1.25".

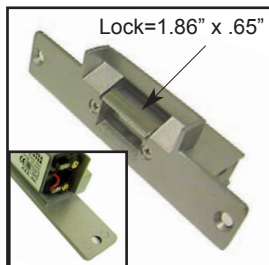

95-902 ELECTRONIC BEEPER HORN

Highly advanced, small in size, low in power consumption. Used in many alarm warning devices.

Specifications

Voltage..... 2 to 24 Vdc
Power Output..... 93 dB at 12 Vdc
Current..... 20 mA max
Size fits into 1/8" hole or mount 1/4" centers
Starting Voltage..... 1.0V max
Color Black
Size..... 1"(H) x 1" (dia).



95-889 ALARm SiREN

Operated from 6 to 12 Vdc. Siren is designed to produce a wobble type sound electrically with amplifier contained in housing. Output is approximately 124 dB ±2 dB, 12 Vdc, with sound pressure meter 10 ft. away. Rated operating current 1 Amp ±0.2 Amp at 12 Vdc. Color: black.



95-890 SELF-CONTAINED SiREN SPEAKER

High-powered, compact siren speaker. Produces loud, ear-piercing warble or steady tone. Operates on either 6 or 12 volts DC and draws only 400 mA of current. Easy-mounting and weather resistant. Color: white. Size: 4"(L) x 4"(W) x 2"(D).



95 Series – Relays & Amplifiers, Paging Amplifiers

95-925
12 Volt SPDT ALARm RELAy
 30/40A contacts. Current draw 120mA. Coil resistance 93 ohms DC. Can be used with Calrad 95-926 or 95-927 relay sockets.



95-926
SiNGLE RELAY SOCKET FOR CAR ALARmS
 Mates with 95-925 12V relay.



95-869B
6-WATT AUDiO AmPLiFiER mODULE
 Solid-State Audio Amplifier Module with max 5 watt output.
Specifications
 Power Supply Voltage 12-15 V
 Frequency Response 10 to 25 KHz.
 Input Impedance Low Z
 Input Sensitivity 6 mv.
 Power Input..... Mono 6 W., 8Ω
 Distortion 1% @ full output

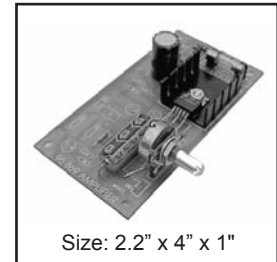

Size: 2.2" x 4" x 1"

95-830
POWER AmPLiFiER

This power amplifier is a very versatile high fidelity amplifier and has many useful applications. A few of these are as follows: A power amplifier for Walkman or similar type of AM/FM stereo headphone radio, they can be converted into a high powered stereo system for home use. This can easily be done by connecting the headphone output from the radio to the input control of the amplifier. As a power amplifier for the auto, van, camper, trailer and boat, or as a portable system for outdoor use. A public address amplifier for both indoor and outdoor use.

Specifications

DC Voltage.....	12 to 15V	Input Sensitivity	0.6V at full output
Frequency Response	10 to 25 kHz	Power Output	Mono: 15W at 8Ω. Stereo: 6W
Input Impedance.....	Low Z	Distortion	1% @ full output

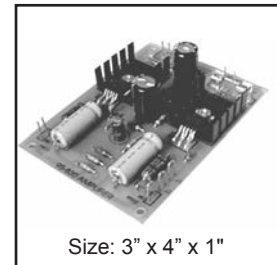

Size: 3" x 4" x 1"

95-702
15 WATT PUBLi ADDRESS AmPLiFiER

Comes complete with microphone. Has inputs for microphone, auxiliary, phone, and microphone auxiliary. Also has built-in siren. Chassis size: 6"(W) x 2.75"(H) x 6.5"(D). 45-602 power supply sold separately for AC use.

Specifications:

Power Source	DC 12V (11-16V standard 14.4V)
Input impedance	Mic 200-50K ohm adaptable / Aux. 10K
Input Level	Mic -50dB ± 1dB / Aux. -22dB ± 1 dB (for rated output)
Output Impedance	4~16 ohmΩ
Power Consumption	Less than 3A at max. output
Siren.....	Electronic operated automatic waving type
Fog-horn.....	Electronic fog-horn
Dimensions	155mm(W) x 150mm(D) x 65mm(H)
Weight.....	0.78kg



Size: 6.1" x 5.9" x 2.55"

95-875
60 WATT PAGiNG AmPLiFiER

Rugged and versatile paging amplifier and mixer. One XLR mic input. Two 1/4" mono mic inputs. Three RCA auxiliary inputs. Independent controls for the microphone and auxiliary inputs allows you to mix and amplify the input signals. Front panel on/off power switch with L.E.D. indicator. Speaker outputs are screw terminals for 4Ω, 8Ω, 70 volt or 100 volt speakers. Inputs for 110 Vac or 12 Vdc. Detachable IEC electrical cord. Chassis color: Black. Includes mounting bracket.



Front

Rear

Note: All specifications on this page are subject to change without notice

CALRAD

95 Series - Stereo Amplifiers & Preamps

95-2020

45 WATT STEREO AUDiO AmPLiFiER

Small, powerful stereo amplifier is perfect for professional and consumer audio applications. Front panel mounted left and right volume controls. Comes with passive heat sink (no fan required) illuminated On/Off rocker switch. Stand alone unit or fits Calrad 4 X 1/4 rack unit p/n 95-2024A.

SPECIFICATIONS

Inputs:..... 1/4" Stereo Jack x 1 (rear)
 Output:..... 1/4" Mono Jack x 2 (rear)
 Output Power:.....45 Watts per Channel MAX
 Input Impedance:..... 50KΩ
 Signal to Noise Ratio: 95dB
 Total Harmonic Distortion: 003%
 Connector 2 Position Male Phoenix (male connector on power supply)
 Power Supply:.... 12Vac @4.5 amps (included)
 Dimensions: 4 3/8" (W) X 5"(D) X 1 1/16"(H)
 Case Color Black

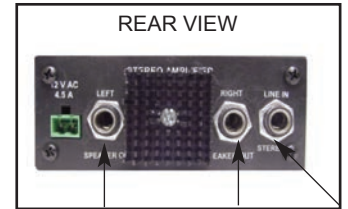

Left Right 1/4" Stereo Line Input
1/4" Speaker Output Jacks

95-2021

STEREO miCROPHONE & LiNE PReAmP

This low noise preamp is perfect for mixing 2 microphones and 1 line input signal sources. Front panel volume controls for each input. illuminated on/off rocker switch. Mono 1/4" mic input jacks rear panel and 1/4" front panel input jack. 1/4" stereo output jack. Stand alone unit or can be mounted in Calrad's 1/4 x 4 19" rack face-plate, part number 95-2025.

SPECIFICATIONS

Inputs:
 Mic1, Mic 2: ...1/4" Mono Jacks X 2 Rear Panel
 Line In:..... 1/4" Stereo Jack X 1 Rear Panel
 Line In:.... 3.5mm Stereo Jack X 1 Front Panel
 Line In:..... 1/4" Stereo Jack X 1 Front Panel
 Output:.....1/4" Stereo Jack X 1Rear
 Signal to Noise Ratio: -68dB
 Frequency Response: 25Hz - 25KHz
 Dynamic Range:..... 130dB
 Power Supply: 12Vac @150mA (included)

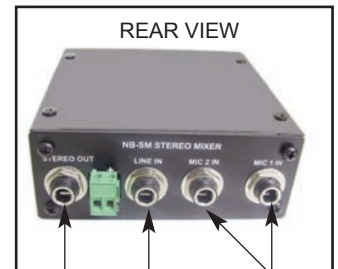

1/4" & 3.5mm Stereo Line Inputs
1/4" Stereo Line Output
1/4" Stereo Line Input
1/4" Mic Inputs

Dimensions:0..... 4 3/8" (W) X 5"(D) X 1 1/16"(H)
 Case ColorBlack

95-2024A

Rack Mount 4 Position 19" Face-Plate
 Dimensions:19"(W) X 1 3/4"(H)
 Face Plate ColorBlack



95-2024A Rack Mountable Face-Plate

95-2026 Wall Bracket

Designed for wall mounting or structured wire panel box.



95-2025
 Black Blank insert for 95-2024A Face-Plate with Calrad Logo

CALRAD

95 Series - Touchscreens

10.4" TOUCH SCREENS

- 95-1062-BK (Black USB)
- 95-1062-BK-KiT (iNWall KiT, BLACK TRim PANEL)
- 95-1062-WH (White USB)
- 95-1062-WH-KiT (iNWall KiT, White TRim PANEL)
- 95-1062BK-RS232 (BLACK RS232)
- 95-1062WH-RS232 (White RS232)

The 95-1062 series touchscreens can be used on a desktop or in-wall applications. Perfect for use with point of sale products or home automation control systems. Easy to setup driver software, available in USB or RS232 interfaces. Adjustable arm for screen tilt and height. Using the optional in-wall kit the screen can be located inside a wall. OSD (Onscreen Display) for Brightness, Contrast, Color, Image settings, Audio. Front panel power, input selection buttons. Video inputs, VGA, Composite Video 1, Composite Video 2. Use Calrads 72-130 adapters to extend RS232 control signals up to 200 ft.. Use USB balun devices on page 155 to extend the USB version. Use Calrad VGA baluns to extend the video signal over 100 ft., see page 85.

Specifications:

- 4-wire resistive Touchscreen (optional):USB or RS232 interface
- VGA input: 15 pin D-SUB analog
- RGB interface PAL/NTSC color system
- High resolution- up to 1024x768 (H x V) formatted
- Automatic display adjustment
- High-Brightness CCFL Backlight
- 2 RCA video inputs, 1 Audio Input, 1 Audio output
- On Screen Display menu control (Multi-language)
- Full-function infrared remote control
- Built-in 2 Watt Amplifier and Speaker
- Screen Size: Diagonal 10.4"
- Dot Resolution (RGB): 800(H) x 600(V) = 1,440,000 (dots)
- Viewing Angle: 100 degrees/75 degrees (H/V)
- Aspect Ratio: 4:3
- Contrast: 500:1
- LCD Brightness: 170cd/m2
- Viewing Angle: 45/60(U/D), 65/65(L/R)
- Operating Voltage: DC 11-13V
- Power Consumption: <10W
- Dimension (mm): 252W x 185H x 267D
- Weight (kg): 1.5
- Colors: Black, White

Accessories:

- VGA Cable: 1 Piece
- Audio Signal Cable(Black): 1 Piece
- Video Signal Cable(Yellow and Buff): 2 Pieces
- 12Vdc 1.5 Amp power supply: 1 Piece
- Remote Control: 1 Piece
- PC Driver Disk: 1 Piece
- Operation Manual: 1 Piece

Note: All specifications on this page are subject to change without notice

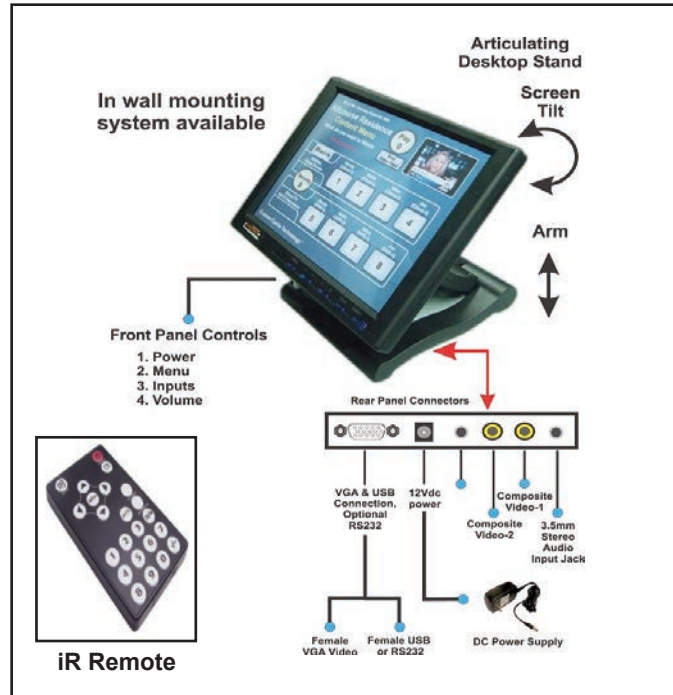

95-1062 iNWall BRACKET KiT

In-Wall Bracket



In-Wall Trim Plate



Drywall Trim Brackets



72-130 SERIAL CAT5E ADAPTERS

Connect RS232 devices using standard UTP Cat5e cable. Distances of over 200 ft. at 9600 baud can be achieved.



3 Piece kit includes 2 - DB9 Male to RJ45 adapters, 1- gender changer

Visit Calrad on the web at: www.calrad.com

95 Series - AC Plugs, Wall Adapters, Splitters

95-790

CHASSIS MOUNT AC RECEPTACLE

Solder type, 3-prong (grounding type) jack. Snap-in mounting. UL approved. 15A/125V. Mounts in 1.06"(W) x .87"(H) hole. Overall depth 1.28". Black plastic body.

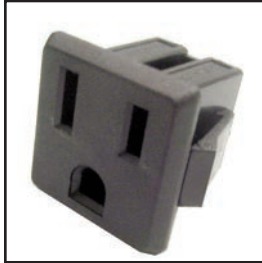

95-771

FEMALE AC SOCKET

Solder type, recessed female AC panel jack. 10A at 250Vac. Black plastic body. US and CSA approved. Mounts in 1.27"(W) x .96"(H) hole. Overall depth 1.25" with 1.55" mounting centers. Black plastic body.



95-791

CHASSIS MOUNT AC RECEPTACLE

Solder type, 2-prong (polarized) jack. Snap-in mounting. UL approved. 15A/125V. Mounts in .95"(W) x .48"(H) hole. Overall depth 1.13". Black plastic body.



95-772

HEAVY DUTY iNLINE mALE AC PLUG

Solder type, inline 3 conductor male AC connector. 10A at 250Vac. Black plastic body.



95-770

mALE AC SOCKET

Solder type, recessed male AC panel jack. 10A at 250Vac. Black plastic body. US and CSA approved. Mounts in 1.1"(W) x .74"(H) hole. Overall depth 1.25" with 1.55" mounting centers. Black plastic body.



95-773

HEAVY DUTY iNLINE FEMALE AC PLUG

Solder type, inline 3 conductor female AC connector. 10A at 250Vac. Black plastic body.



95-770-SNAP

Snap-in version, US and CSA approved. Mounts in 1.025" (W) x .84"(H) hole. Overall depth .96". Black plastic body.

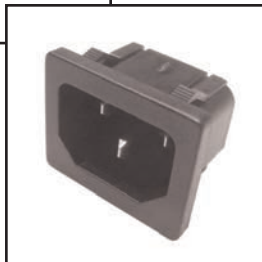

95-777

2 WAY AC SPLITTER

1 male AC 3 prong to 2 Females, Rubber Body, Color is Black.



95-776

2 WAY iEC/AC SPLITTER

1 IEC Male to 1 AC 3 prong and 1 IEC Females, rubber Body.



95-792-GN Green

95-792-OR Orange

3 Way AC Grounding Wall tap.

Available in either green or orange color options. 110/125Vac, 15 amp rating. UL listed, rubber Body.



95-796

SINGLE OUTLET SURGE PROTECTOR

1-mov, 90-joules. LED power indicator. 120 Vac, 15 amp, 1875 watt rating. UL listed.



CALRAD

95 Series - AC Adapters, Power Strips

95-795 AC 3 WIRE GROUND ADAPTER

120 Vac - 20 amp rating. Rubber body.

95-795-UL POLARIZED AC 3 WIRE GROUND ADAPTER

120 Vac - 20 amp rating. Plastic body.

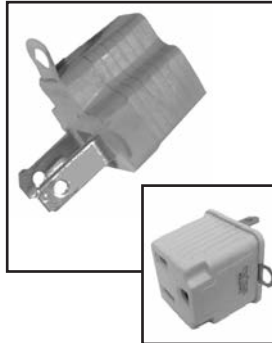

95-786 9 OUTLET mODEm/TV SURGE PROTECTOR

Child protected slide outlet covers suitable for DSS dish installation. 3 transformer spaced outlets. 6-mov, 840-joules. 3 Line protection. EMI-RFI noise filtered. Built-in resettable circuit breaker. ON-OFF illuminated rocker switch. LED surge and ground fault indicator. Surge fail audible alarm alert. 6 ft. 14 awg heavy duty power cord. UL/CSA listed. High impact ABS plastic housing.



95-793 3-OUTLET SURGE PROTECTOR

270-joules. LED surge and ground fault indicator. UL/CSA listed. 125 Vac, 15 amp rating.



95-788 8 OUTLET DBS SURGE PROTECTOR

TV-DSS surge protector used for DSS satellite installations. 3-class 2 transformer spaced outlets. 5-MOV 1680 joules, 3 line protection EMI-RFI noised filtered up to 60dB from 100KHz to 10MHz. Protects phone/fax/modem, satellite, cable coax connections. Illuminated breaker switch. L.E.D. surge and ground fault indicator. Surge fail audible alarm alert. 6 ft. 14 awg heavy duty power cord. Max surge voltage of 6500. 5-2250Mhz premium 'F' connectors. Child protected slide outlet covers. High impact ABS plastic housing. UL/CSA listed. UL497A, 1993, 1449. Size: 4.5"(W) x 1.74"(H) x 11.5"(D). Color is white.



95-794 TRIPLE OUTLET ADAPTER

Converts 1 AC outlet to 3 outlets. 120 Vac - 15 amp rating.



95-785 6 OUTLET mODEm/FAX SURGE PROTECTOR

Child protected slide outlet covers. 3-mov, 270-joules. 3 Line protection. EMI-RFI noise filtered. Built-in resettable circuit breaker. ON-OFF illuminated rocker switch. LED surge and ground fault indicator. 6 ft. 14 awg heavy duty power cord. UL/CSA listed. High impact ABS plastic housing.



95-783 6 OUTLET ADAPTER WITH SURGE PROTECTION (mETAL)

1-mov, 90-joules basic protection. Resettable circuit breaker. Illuminated ON-OFF rocker switch. 4 ft., 14 awg heavy duty cord. Baked enamel ivory finish.



95-780 6 OUTLET HEAVY DUTY SURGE PROTECTOR WITH CORD mANAGEMENT

Comes with 6 outlets, 2 configured for power supplies and 4 standard spaced outlets. Integrated illuminated breaker switch. 14 AWG, 6 ft. grounded power cable. Built in mounting brackets and heavy duty steel housing UL/CSA approved. Color is yellow.



95-783-P (Straight AC Plug) 95-783-P-RT (Right Angle AC Plug) 6 OUTLET ADAPTER WITH SURGE PROTECTION (PLASTic)

Provides protection against noisy AC power. MOV circuitry for reducing harmful power spikes and surges, reduces, RFI and EMI signals. On/Off power switch with 15A circuit breaker. 3 ft. 14 AWG, 3 prong AC cord. Maximum surge dissipation 59 joules. Maximum surge voltage 6000 volts. Maximum spike current 4500 amps. Response time less than 1 nanosecond. UL/CSA listed. High impact ABS plastic housing.



95-781 8 OUTLET HEAVY DUTY SURGE PROTECTOR WITH CORD mANAGEMENT

Comes with 8 outlets, 3 configured for power supplies and 5 standard spaced outlets. Integrated illuminated breaker switch. Built in mounting brackets, heavy duty steel housing. 14 AWG 6 ft. grounded power cable. UL/CSA approved. Color is yellow.



Visit Calrad on the web at: www.calrad.com

CALRAD

Numerical Index

10 Series to 30 Series

10 SERIES				25 SERIES					
10-3	4	10-127	1	25-271	21	28-116-IV	31	30-250-BU	36
10-9	5	10-130	2	25-275	21	28-116-P	31	30-250-GN	36
10-10	3	10-131	1	25-276	21	28-116P-4	31	30-250-OR	36
10-12	4	10-140-5	7	25-277	21	28-116P-5	31	30-250-RD	36
10-15A	3	10-140-10	7	25-290	20	28-116P-6	31	30-250-WH	36
10-17	2	10-140-15	7	25-294	20	28-117-P	27	30-250-YL	36
10-19	5	10-141-5	7	25-295	20	28-118	27	30-255	38
10-20	4	10-141-10	7	25-300	20	28-119	27	30-256	38
10-22	4	10-141-15	7	25-300A	20	28-120	32	30-257	38
10-31	10	10-142-5	7	25-301	20	28-122-2	25	30-288-BK	37
10-31-BK	10	10-142-10	7	25-302	20	28-122-4	25	30-288-BU	37
10-32	10	10-142-15	7	25-303	20	28-122-6	25	30-288-GN	37
10-33	10	10-143-5	7	25-304	20	28-122-8	25	30-288-OR	37
10-34	9	10-143-10	7	25-305	20	28-122-IV-2	25	30-288-RD	37
10-35	9	10-143-15	7	25-306	20	28-122-IV-4	25	30-288-WH	37
10-36-6	9	10-144	7	25-307	20	28-122-IV-6	25	30-288-YL	37
10-36-13	9	10-145	7	25-308	20	28-122-IV-8	25	30-289	35
10-36-19	9	10-145-1	7	25-309	20	28-122-S-2	25	30-289-BK	35
10-36-6-BK	9	10-145RT-1	7	25-310	20	28-122-S-4	25	30-289-BU	35
10-36-13-BK	9	10-146	7	25-316	20	28-122-S-6	25	30-289-GN	35
10-36-19-BK	9	10-147	7	25-317	20	28-122-S-8	25	30-289-RD	35
10-37	5	10-148-3	7	25-318	20	28-123	26	30-289-WH	35
10-45-20	8	10-148-6	7	25-322	20	28-124	25	30-289-YL	35
10-45-25	8	10-148-10	7	25-324	20	28-125	27	30-290	35
10-50	5	10-148-15	7	25-325	20	28-126	27	30-291	35
10-54	9	10-149-3	7	25-326	20	28-127	27	30-292	35
10-55	9	10-149-6	7	25-327	20	28-128	32	30-293-BK	35
10-56	9	10-149-10	7	25-328	20	28-129	32	30-293-BU	35
10-58	10	10-149-15	7	25-329	20	28-131	32	30-293-GN	35
10-59	9	10-150	7	25-330	20	28-130	32	30-293-RD	35
10-59A	9	10-150A	7	25-331	20	28-132	25	30-293-WH	35
10-60	10	10-151	7	25-339	22	28-140-W	23,33, 172	30-293-YL	35
10-61A	10	10-151A	7	25-339A	22	28-145-AL	23,33	30-293S-BK	35
10-63A	10	10-152	7	25-341	21	28-145-BK	23,33	30-293S-BU	35
10-64A	10	10-153-1	7	25-342A	21	28-145-IV	23,33	30-293S-GN	35
10-65	9	10-154-1	8	25-345	24	28-145-WH	23,33	30-293S-RD	35
10-67-BK	5	10-155-1	8	25-346	24	28-150	27	30-293S-WH	35
10-67-GN	5	10-156-1	8	25-347	24	28-150G	27	30-293S-YL	35
10-67-RD	5	10-157-1	8	25-348	24	28-151	27	30-294-1855A	36
10-67-YL	5	10-158-6	8	25-351A	22	28-151G	27	30-294-8218	36
10-68-BK	5	10-160-10	8	25-352	21	28-152	27	30-294-RG59	36
10-68-BU	5	10-160-25	8	25-352-S	21	28-153	27	30-294-RG6	36
10-68-GN	5	10-160-50	8	25-353	21	28-154	27	30-295	39
10-68-OR	5	10-160-100	8	25-354	22	28-159	28	30-295-1/2	39
10-68-RD	5	10-161-10	8	25-355	22	28-160	28, 92	30-295-HEX	39
10-68-YL	5	10-161-25	8	25-356	23	28-160G	28	30-295G	39
10-69-BK	5	15 SERIES		25-357	22	28-161	28, 92	30-296-BK	38
10-69-GN	5	15-93-20	14	25-357A	22	28-161-3.5	28, 92	30-296-GN	38
10-69-RD	5	15-95	14	25-360	22	28-161-T	29, 92	30-297-BK	38
10-69-YL	5	15-96	14	25-361	23	28-161G	28, 92	30-298-BK	35
10-75	10	15-106	14	25-362	23	28-162	28, 92	30-298-RD	35
10-76	6	15-110	14	25-372	21	28-162G	28, 92	30-298-WH	35
10-77	6	15-118	13	25-379	21	28-162M-2	28, 92	30-298G-BK	35
10-78	6	15-122A	13	25-390	21	28-163P	29, 76	30-298G-RD	35
10-78-RCA	6	15-123	13	25-391	21	28-163PC	29, 76	30-298G-WH	35
10-79	6	15-131	15	25-395	20	28-164-M	29, 76	30-299-RG59	36
10-82	5	15-132	15	25-396	20	28-164-M-2	29, 76	30-299-RG6	36
10-83	9	15-133	15	25-397	20	28-165	26	30-299-8218	36
10-86	6	15-135	13	25-398	20	28-165G	26	30-299-1855A	36
10-87	6	15-135-RA	13	25-405	20	28-166	29, 89	30-300-BK	37
10-88	6	15-143	14	25-406	20	28-166G	30, 89	30-300-GN	37
10-89	6	15-144	13	25-407	20	28-167-LP	29, 89	30-300-OR	37
10-90	3	15-145A	14	25-411	20	28-168-1	30, 89	30-300-WH	37
10-90-BAT	3	15-145A-RT	14	25-412	20	28-168-2	30	30-300-YL	37
10-91	3	20 SERIES		25-420	20	28-169-1	30, 89	30-302-BK	36
10-91-BAT	3	20-174	16	25-421	20	28-169-2	30, 89	30-302-RD	36
10-91-C	3	20-176	16	25-422	20	28-170	27	30-302-WH	36
10-95-1	8	20-177	16	25-423	20	28-171-1	30, 89	30-302-YL	36
10-95-1-5	8	20-211	18	25-424	20	28-171-2	30, 89	30-303-BK	35
10-95-2	8	20-215	18	25-428	20	28-172	89	30-303-BU	35
10-95-3	8	20-218	17	25-429	20	28-180-1	31	30-303-GN	35
10-95-6	8	20-218VC	17	25-430	20	28-180-1-IV	31	30-303-RD	35
10-95-10	8	20-224	16	25-431	20	28-180-2	31	30-303-WH	35
10-95-15	8	20-224A	16	25-432	20	28-180-2-IV	31	30-303-YL	35
10-95-25	8	20-225	16	25-433	20	28-180-3	31	30-305	36
10-95-50	8	20-225R	16	25-452	21	28-180-3-IV	31	30-306	36
10-95-100	8	20-226	16	25-453	21	28-180-4	31	30-307	35
10-95B	8	20-227	16	25-454	21	28-180-4-IV	31	30-308	35
10-95B-250-HG	8	20-228	16	28 SERIES		28-180-6	31	30-308K-S	36
10-96-10	8	20-229	16	28-100-P	25	28-180-6-IV	31	30-309	35
10-96-15	8	20-231	17	28-101-P	25	28-180-8	31	30-310	42
10-96-20	8	20-232	17	28-102-P	25	28-180-8-IV	31	30-311	42
10-96-25	8	20-233	17	28-103-P	26	28-180-HP-BK	31	30-314	41
10-97	10	20-244	18	28-104-P	26	28-181-IV	33, 142	30-315	41
10-99	6	20-250	17	28-105-P	26	28-181-WH	33, 142	30-316	40
10-105	11	20-262-BK	19	28-106-P	26	28-190	31	30-317	40
10-110	12	20-262-W	19	28-107-P	26	28-202D	26, 63	30-318	38
10-112-BLANK	11	20-280	17	28-108-P	26	28-CEDH1	33, 142	30-319	38
10-112-BNC	11	20-298	17	28-109-P	28	28-CED1-BK	33, 142	30-319-F	39
10-112-I-BNC	11	20-301	17	28-110-P	28	28-CER-1	33, 142	30-320	38
10-112-RCA	11	20-310	18	28-111-P	28	28-CER-2	33, 142	30-321	38
10-113	11	20-311	18	28-114	31	28-LV1RP	33, 142	30-322	38
10-115	10	20-312	18, 193	28-114	31	28-LV2RP	34, 142	30-322J-4	38
10-117	12	20-313	18	28-113	31	28-TVBU505	34	30-322J-6	38
10-119	12	20-330	19	28-113-IV	31	28-TVBR505	34	30-322J-8	38
10-120	1	20-331	19	28-114-IV	31	28-LVU1W	34	30-324	38
10-126	2	20-335	19	28-115-IV	31	28-LVU1BL	34	30-325	38
		20-337	19	28-115-P	31	30 SERIES		30-326	38
						30-250-BK	36	30-327	38
								30-328	38
								30-329	38
								30-330	38
								30-331	38
								30-333	41
								30-334	41
								30-336	41
								30-337	41
								30-340	42
								30-341	42
								30-343	42
								30-344	42
								30-346	42
								30-347	42
								30-348	42
								30-349	42

30 Series to 40 Series

Numerical Index

30-410-3-8-BK	37	30-454	44	30-529-BK	45	30-607S-RD	35	35-445	52	35-579B	55
30-410-3-8-BU	37	30-455	44	30-529-SL	45	30-607S-WH	35	35-446	52	35-580A	52
30-410-3-8-GN	37	30-455-M	44	30-534	45	30-607S-YL	35	35-450	49	35-582-NK	53
30-410-3-8-OR	37	30-456	44	30-534-BK	45	30-608	37	35-451	49	35-584G	51
30-410-3-8-RD	37	30-457	44	30-535	45	30-609-RD	43	35-452	49	35-585G	51
30-410-3-8-W	37	30-458	44	30-536	40	30-609-WH	43	35-453	49	35-586G	51
30-410-3-8-YL	37	30-460	43	30-537	40	30-610-RB	43	35-454	49	35-587G	51
30-410-BK	37	30-461	43	30-539	45	30-610-RBBK	43	35-455	49	35-588G	51
30-410-BU	37	30-465	45, 168	30-539-BK	45	30-610-RBRD	43	35-456	49	35-590	55
30-410-GN	37	30-467	44, 168	30-540-BK	45	30-611	37	35-457	49	35-591	54
30-410-OR	37	30-468	44, 168	30-540-SL	45	30-612	43	35-458	49	35-592	55
30-410-RD	37	30-469	45, 167	30-542	44	30-613	43	35-459	49	35-593	55
30-410-YL	37	30-470	45, 167	30-543	44	30-613-BK	43	35-460	49	35-594	55
30-410G-3-8-BK	37	30-471	45, 167	30-546	44	30-613-RD	43	35-461	49	35-600	76
30-410G-3-8-BU	37	30-472	45, 167	30-550	46	30-614-BK	43	35-462	49	35-601	76
30-410G-3-8-GN	37	30-473	45, 167	30-550-M	47	30-614-RD	43	35-463	49	35-610	55
30-410G-3-8-OR	37	30-474	45, 167	30-550-MH	47	30-615-BK	43	35-464	49	35-700	50, 76, 83, 92, 94
30-410G-3-8-RD	37	30-475	45, 168	30-550-PH	47	30-615-RD	43	35-465	49	35-701	50, 76, 92
30-410G-3-8-WH	37	30-477	40	30-551	46	30-616-2-1	41	35-465A	49	35-702	50, 76
30-410G-3-8-YL	37	30-478	40	30-551-HD	46	30-616-2-5	41	35-466	49	35-703	50, 76
30-410G-BK	37	30-479	39	30-551-M	47	30-617-2-1	41	35-467	49	35-704	92
30-410G-BU	37	30-482	44	30-551-MH	47	30-617-2-5	41	35-468	49	35-704-A	92
30-410G-GN	37	30-483	44	30-551-PH	47	30-618	38	35-469	49	35-709	50
30-410G-OR	37	30-484	38	30-552	46	30-618-6	38	35-476	55	35-710-A	50, 76
30-410G-RD	37	30-485	39	30-552-M	47	30-618-8	38	35-477	55	35-711A	50, 75, 76, 94
30-410G-WH	37	30-485A	39	30-552-MH	47	30-619	38	35-484-A	52	35-712A	50, 76
30-410G-YL	37	30-486	36	30-552-PH	47	30-620	40	35-494	48	35-713-A	50
30-411	40	30-487	39	30-553M	46	30-621	40	35-495	48	35-714	50
30-412-A	41	30-487A	39	30-553M-G	46	30-622-BK	46	35-496-4	48	35-714A	50
30-413	40	30-487G	39	30-553M-RA	46	30-622-BU	46	35-496-6	48	35-715	50, 76
30-414	39	30-488	38	30-553M-RA-G	47	30-622-GN	46	35-496-8	48	35-716	50, 76
30-415-BK	40	30-488A	38	30-554	46	30-622-OR	46	35-497	48	35-717	50, 76
30-415-RD	40	30-488G	38	30-555	46	30-622-RD	46	35-497A	48	35-718	50
30-415M	40	30-489	38	30-556	46	30-622-YL	46	35-497A-6	48	35-718-A	50
30-416	38	30-490	38	30-557	46	30-623-2-1	41	35-498	48	35-720	51, 63
30-416-RD	38	30-491	40	30-560	46	30-623-2-5	41	35-498-6	48	35-721	51
30-417	39	30-491T	40	30-561	46	30-624-2-1	41	35-498-8	48	35-722	92
30-418	40	30-492	39	30-561-HD	46	30-624-2-5	41	35-498-BH	48	35-726	50
30-418G	40	30-493A	39	30-562	46	30-630-BK-3	45	35-498-BH-6	48	35-727	76
30-419	40	30-493A-6"	39	30-574	47	30-630-BK-4	45	35-498-BH-8	48	35-730	63
30-419G	40	30-494A	39	30-575	47	30-630-BK-5	45	35-498G-BH	48	40 SERIES	
30-420	40	30-495	44	30-576	47	30-630-SL-3	45	35-498G-BH-6	48	40-1010	85, 189
30-421	38	30-496	44	30-577	47	30-630-SL-4	45	35-498K-S	38, 48	40-1030	74
30-422	40	30-497	44	30-578	47	30-630-SL-5	45	35-499	48	40-1060-2	74
30-423A	39	30-498	44	30-579	47	30-631-BK-3	45	35-499-BNC	48	40-1060-4	74
30-424-BK	37	30-499	44	30-580	46	30-631-BK-4	45	35-499F-BNC	48	40-1061-1.3-1	80
30-424-RD	37	30-500	44	30-581	47	30-631-BK-5	45	35-499-SF	48	40-1061-1.3-2	80
30-424-WH	37	30-501	44	30-582	47	30-631-SL-3	45	35-499-P	48	40-1061-1.3-4	80
30-424-YL	37	30-502	44	30-582-MF	47	30-631-SL-4	45	35-499-SF-P	48	40-1061-1.3-8	80
30-425-BK	37	30-503	44	30-583	47	30-631-SL-5	45	35-499-S-P	48	40-1062-1.3-10	80
30-425-RD	37	30-504	44	30-584-F	47	30-632	41	35-499-BNC-P	48	40-1061-16	80
30-426	36	30-505	37	30-584-M	47	30-635	41	35-499-S	48	40-1070	77
30-426-BK	36	30-505-6	37	30-585	47	30-638	46	35-501A	54	40-1072M	77
30-426-RD	36	30-505-8	37	30-586	47	30-640-3	46	35-502G	51	40-1074	29, 89
30-427	35	30-505-LK	38	30-587	47, 92	30-640-4	46	35-503G	51	40-1075	29, 89
30-428-BK	37	30-505-RA-6	37	30-587G	47, 92	30-640-5	46	35-504G	51	40-1090	77
30-428-BU	37	30-505-RA-8	37	30-587-MF	47	30-640-6	46	35-506-P	52	40-1093	77
30-428-GN	37	30-505-RA-RG174	37	30-588	47, 92	30-641-3	46	35-510G	63	40-1094	77
30-428-OR	37	30-506	38	30-588G	47, 92	30-641-4	46	35-516G	51	40-1095	78
30-428-RD	37	30-506-L	38	30-590	5, 46	30-641-5	46	35-517	52	40-1096	78
30-428-W	37	30-507	38	30-590-BK	5, 46	30-641-6	46	35-517G	52	40-2551	78
30-428-YL	37	30-507-6	38	30-592-6	47	30-641M-3	46	35-518M	53	40-281H	61
30-428G-BK	37	30-507-8	38	30-592-8	47	30-641M-4	46	35-519G	51	40-283HD	61
30-428G-BU	37	30-507T	38	30-592-8-BK	47	30-641M-5	46	35-523	55	40-40AN2420	83
30-428G-GN	37	30-508	44	30-592-8M	47	30-641M-6	46	35-524	55	40-40AN2440	83
30-428G-RD	37	30-509	44	30-592-8M-BK	47	30-642-3	46	35-525-HG	53	40-40VC01	87
30-428G-W	37	30-510	44	30-593	47	30-642-4	46	35-525-HGM	53	40-40VH01	79
30-428G-YL	37	30-510-M	44	30-594	47	30-642-5	46	35-525-MZ	53	40-40VH02	79
30-429	35	30-511	44	30-595	46	30-642-6	46	35-527G-6	54	40-YD02A	57
30-430-BK	36	30-512	44	30-596	46	30-643-3	46	35-530-HGM	53	40-40YE01D	56
30-430-BU	36	30-512-M	44	30-597	47	30-643-4	46	35-532	55, 133	40-40YH01	79
30-430-GN	36	30-513	44	30-597-2	47	30-643-5	46	35-533	55	40-4140	91
30-430-RD	36	30-514-BK	46	30-598	47	30-643-6	46	35-534	55	40-480	61
30-430-W	36	30-515	45	30-598-2	47	30-700A	39	35-536	52	40-481	61
30-430-YL	36	30-516	45	30-599	47	30-701	39	35-536-P	52	40-482	62
30-433	44	30-517	46	30-600-BK	42	30-701A	39	35-538-P	53	40-502	96
30-434	45	30-518	44	30-600-RD	42	30-702	39	35-539-P	53	40-503	96
30-436	44	30-518-M	44	30-600-RB-BK	42	30-705	39	35-544	52	40-511	96
30-437	44	30-519	44	30-600-RB-RD	42	30-706	39	35-545-S	53	40-512	96
30-438	43	30-520-BK	45	30-601	43, 175	30-707	39	35-546-NK	53	40-513	96
30-439	43	30-520-SL	45	30-601-BK	43, 175	30-710	39	35-546G	53	40-521	96
30-440	43	30-521-BK	45	30-601-RD	43, 175	30-711	39	35-549-NK	52	40-523	96
30-440-NK	43	30-521-SL	45	30-601S-BK	43, 175	30-712	39	35-550-NK	52	40-5526	60
30-441	43	30-522-BK	45	30-601S-RD	43, 175	30-712K-S	39	35-550G	52	40-560	95
30-441-NK	43	30-522-SL	45	30-602-BK	42	30-712K-S-2	39	35-551-NK	52	40-561	95
30-442	42	30-522-SL-4	46	30-602-RD	42	30-713	39	35-551G	52	40-562	95
30-442G	42	30-522-SL-5	46	30-603	42	30-714	39	35-552A	53	40-563	95
30-443	42	30-523-BK	45	30-604-BK	42	30-715	39	35-553G	51	40-565	98
30-443G	42	30-523-BK-4	46	30-604-RD	42	30-720-2-1	41	35-554G	51	40-566	96
30-444	43	30-523-SL	45	30-604-CT-BK	42	30-720-2-5	41	35-556	55	40-567	96
30-445	43	30-523-SL-4	46	30-604-CT-RD	42	30-721	42	35-558-6	54	40-568	96
30-446	36	30-523-SL-5	46	30-605-BK	42	30-730	41	35-562	133	40-569	96
30-447	36	30-524	46, 49	30-605-RD	42	30-731	41	35-566	52	40-580	95
30-448	36	30-525	46, 49	30-606-BK	43	35 SERIES		35-567	51	40-581	95
30-449	36	30-526-BK	45	30-606-RD	43	35-439	48	35-568	52	40-582	95
30-451	44	30-526-SL	45	30-607-BK	35	35-440	48	35-570	55	40-583	95
30-451-M	44	30-527-BK	45	30-607-RD	35	35-441	48	35-571	55	40-584	95
30-452	44	30-527-SL	45	30-607S-BK	35	35-442	48	35-573	54	40-585	95
30-453	44	30-528-BK	45	30-607S-BU	35	35-443	48	35-576	55	40-586	95
30-453-M	44	30-528-SL									

CALRAD

Numerical Index

40 Series to 55 Series

40-588	95	40-720PHD	62, 79	42-100-1.5M	101	45-774-50	102	55-502-50	12, 120	55-612-35	112
40-589	95	40-750	99	42-100-2M	101	45-775	102	55-503-1	120	55-612-50	112
40-593	95	40-751	99	42-105	101	45-775-50	102	55-503-2	120	55-612-6-INCH	112
40-594	95	40-752	99	42-107-RT-RT	101	45-776	102	55-503-3	120	55-612-6	112
40-595	97	40-753-GY	99	42-107-ST-ST-3	101	45-776-2.5	102	55-503-4	120	55-612-6-WH	112
40-596	97	40-755	99	42-107-ST-RT-2	101	45-777	102	55-503-5	120	55-612-75	112
40-600	95	40-756	99	42-107-ST-RT-3	101	45-778	109	55-503-S-1	120	55-612-HDTV-10	112
40-601	95	40-758	100	42-115	101	45-780	109	55-503-S-2	120	55-612-HDTV-100	112
40-602	95	40-760	98	42-130	101	45-781	109	55-503-S-3	120	55-612-HDTV-12	112
40-605	95	40-761	98	42-160	101	45-781A	109	55-503-S-4	120	55-612-HDTV-25	112
40-606	95	40-762	98	45 SERIES		45-782	109	55-503-S-5	120	55-612-HDTV-3	112
40-608	96	40-763	98	42-165	101	45-782A	109	55-504-1	120	55-612-HDTV-35	112
40-609	96	40-764	98	45-601	103	45-783	109	55-504-2	120	55-612-HDTV-50	112
40-610	96	40-765	98	45-602	103	45-783A	109	55-504-3	120	55-612-HDTV-6	112
40-611	96	40-768	100	45-603	103	45-784	109	55-504-4	120	55-612-HDTV-75	112
40-612	96	40-769	100	45-606	104	45-784A	109	55-504-5	120	55-612-S-10	112
40-613	96	40-803	68	45-607	104	45-785A	109	55-505-2	116	55-612-S-100	112
40-614	96	40-804M	64	45-611	103	45-786	109	55-505-3	116	55-612-S-12	112
40-615	97	40-809-8	65	45-650-12	104	45-787	109	55-505-4	116	55-612-S-25	112
40-615-W	97	40-812	65	45-650-15	104	45-790	104	55-505-5	116	55-612-S-3	112
40-616	97	40-812-5	65	45-650-18	104	45-791	104	55-506-2	116	55-612-S-35	112
40-620	97	40-813	68	45-650-24	104	45-792	109	55-506-3	116	55-612-S-50	112
40-621	97	40-814	59	45-650-3	104	45-793	109	55-506-4	116	55-612-S-75	112
40-622	97	40-816M	59	45-650-4.5	104	45-795	104	55-506-5	116	55-612-S-6	112
40-6220	85	40-817M	59	45-650-6	104	45-796	104	55-507-2	119	55-612-SP	63, 111
40-623	97	40-8180	91	45-650-7.5	104	45-797	104	55-507-3	119	55-612B	136
40-625	98	40-8188	91	45-650-9	104	45-798	104	55-507-4	119	55-613-12	113
40-626	97	40-822-200	88	45-698	106	45-799	104	55-507-5	119	55-613M-10	113
40-627	97	40-822-350	88	45-699	106	45-801	109	55-508-2	119	55-613M-100	113
40-628	97	40-824-200	88	45-700	105	45-810	104	55-508-3	119	55-613M-15	113
40-629	97	40-824-350	88	45-701	105	45-811	104	55-508-4	119	55-613M-25	113
40-629-BU	97	40-825-8	91	45-702	105	45-812	104	55-508-5	119	55-613M-3	113
40-629-WH	97	40-827M	66	45-703	105	45-813	104	55-509-12	117	55-613M-35	113
40-629-YL	97	40-828-200	88	45-704	105	45-815	104	55-509-6	117	55-613M-50	113
40-630	96	40-828-350	88	45-705	105	45-816	104	55-510-10	117	55-613M-6	113
40-632	97	40-829-2	90	45-706	105	45-817	104	55-510-12	117	55-613M-75	113
40-634	98	40-829-4	90	45-707	105	45-818	104	55-510-6	117	55-614-10	112
40-635	95	40-829-8	90	45-708	105	45-820	106, 181	55-520-GN-2	120	55-614-100	112
40-635A	95	40-829R-4	90	45-709	105	45-821	106, 181	55-520-GN-3	120	55-614-12	112
40-636	97	40-829R-8	90	45-710	105	45-822	106	55-520-GN-4	120	55-614-25	112
40-637	97	40-830M	68	45-711	105	45-824	106	55-520-GN-5	120	55-614-3	112
40-637-S	97	40-838-BNC	65	45-712	106	45-840	104	55-520-PR-3	120	55-614-35	112
40-644	70	40-838-RCA	65	45-713	106	45-900	108	55-520-PR-4	120	55-614-50	112
40-647	70	40-839	66	45-714	106	45-901	108	55-520-RD-2	120	55-614-6	112
40-648	70	40-841M	67	45-715	105	45-902	108	55-520-RD-3	120	55-614-75	112
40-649	70	40-844M	58	45-716	105	45-903	108	55-520-RD-4	120	55-614-EL-100PP	110
40-650	100	40-848M	58	45-720	105	45-904	108	55-520-RD-5	120	55-614-EL-12PP	110
40-650A	100	40-849M	58	45-720L	105	45-905	108	55-520-YL-2	120	55-614-EL-15PP	110
40-651	98	40-851VC	70	45-721	105	55 SERIES		55-520-YL-3	120	55-614-EL-25PP	110
40-652	100	40-880-A	62, 86	45-721L	105	55-1000	124	55-520-YL-4	120	55-614-EL-35PP	110
40-654	100	40-881	75, 86	45-722	105	55-1000B-100	124	55-520-YL-5	120	55-614-EL-50PP	110
40-655	99	40-882	75	45-722L	105	55-1000B-1000	124	55-610-10	117	55-614-EL-75PP	110
40-656	99	40-883	75, 94	45-723	105	55-1000B-9	124	55-610-100	117	55-614-HDTV-10	112
40-657	99	40-884	86, 94	45-723L	105	55-1000B-12	124	55-610-12	117	55-614-HDTV-100	112
40-658	99	40-885	87	45-726	105	55-1000B-15	124	55-610-15	117	55-614-HDTV-12	112
40-659	99	40-886	75, 87	45-726L	105	55-1000B-35	124	55-610-25	117	55-614-HDTV-25	112
40-660	99	40-888	63, 86	45-727	105	55-1000B-50	124	55-610-3	117	55-614-HDTV-3	112
40-661	99	40-889	88	45-727L	105	55-1000B-75	124	55-610-33	117	55-614-HDTV-35	112
40-663A	100	40-930M	66	45-728	105	55-1001	124	55-610-35	117	55-614-HDTV-50	112
40-664	99	40-936B	64	45-734	109	55-1002	124	55-610-50	117	55-614-HDTV-6	112
40-665	99	40-937B	57	45-739	109	55-1003G-10	124	55-610-500	117	55-614-HDTV-75	112
40-666	99	40-939B	57	45-740	107	55-1003G-3	124	55-610-6	117	55-614-S-10	112
40-667	99	40-940M	67	45-741	107	55-1003G-6	124	55-610B	136	55-614-S-100	112
40-668	99	40-948M	67	45-742A	109	55-1004G-15	124	55-611-10	117	55-614-S-12	112
40-670	100	40-963M	60	45-746	102	55-1005	124	55-611-100	117	55-614-S-25	112
40-671	100	40-964M	60	45-746-2.1	102	55-1007	124	55-611-12	117	55-614-S-3	112
40-672	100	40-967M	81	45-748	106	55-1008	124	55-611-15	117	55-614-S-35	112
40-673	100	40-968M-4	82	45-749	106	55-1010G	124	55-611-20	117	55-614-S-100	112
40-674	98	40-968M-8	82	45-751	102	55-1011G	124	55-611-25	117	55-614-S-50	112
40-675	98	40-970	84	45-752	103	55-1013G	124	55-611-250	117	55-614-S-6	112
40-676	100	40-973	84	45-752A	103	55-1015G	124	55-611-3	117	55-614-S-75	112
40-678	98	40-975	84	45-753	103	55-1016G-3	124	55-611-33	117	55-615B	135
40-682	100	40-977	84	45-753A	103	55-1016G-6	124	55-611-35	117	55-615-3	116
40-683	100	40-979	84	45-754	102	55-1016G-10	124	55-611-50	117	55-615-6	116
40-687	97	40-991	81	45-754A	102	55-1016G-15	124	55-611-500	117	55-615-10	116
40-688	97	40-992-1.3	81	45-755	103	55-1016G-25	124	55-611-6	117	55-615-12	116
40-689	97	40-998-HS	81	45-756	102	55-1018G	124	55-611-RCA-10	117	55-615-15	116
40-690	97	40-CDL-160ETH	69	45-757	102	55-1020G	129	55-611-RCA-100	117	55-615-20	116
40-691	95	40-CPHD-1	94	45-757-2.1	102	55-1021G	129	55-611-RCA-12	117	55-615-25	116
40-692	95	40-CVO1A	72	45-757-2.5	102	55-1022G	129	55-611-RCA-15	117	55-615-330	116
40-6920	93	40-CW01A	72	45-758	105	55-1025	131	55-611-RCA-20	117	55-616-12	117
40-693	97	40-DA01	64, 72	45-759	105, 192	55-1026	131	55-611-RCA-25	117	55-616-25	117
40-6930	93	40-DA02	64, 72	45-760	102	55-1027	131	55-611-RCA-3	117	55-616-6	117
40-694	97	40-DCT-1	70	45-761	102	55-1050-1	127	55-611-RCA-35	117	55-617-12	118
40-6950	93	40-DCT-2	12, 71, 120	45-761-2.1	102	55-1050-2	127	55-611-RCA-50	117	55-617-5	118
40-695A	160	40-DCT-4	71	45-762	102	55-500-1	120	55-611-RCA-6	117	55-617-7	118
40-696	160	40-DCT-9	71	45-763	102	55-500-2	120	55-611B	136	55-617-9	118
40-697	97	40-HW01	30, 89	45-763-2.5	102	55-500-3	120	55-612-10	112	55-618-12	117
40-698	98	40-KM01	73, 155	45-763-S	102	55-500-4	120	55-612-10-WH	112	55-618-25	117
40-699	96	40-UE04H	73, 155	45-764	102	55-500-5	120	55-612-100	112	55-618-6	117
40-700	96	40-UE02	73, 155	45-765	102	55-501-1	120	55-612-12	112	55-620-1	111
40-705	96	40-VKM01	73	45-766	102	55-501-2	120	55-612-12-WH	112	55-620-3	111
40-706	96	40-VSRGB	62	45-767	102	55-501-3	120	55-612-15	112	55-620-6	111
40-707	96	40-YS04D	59	45-767-2.1	102	55-501-4	120	55-612-15-WH	112	55-621	111
40-708	96	40-YW01	72	45-768	102	55-501-5	120	55-612-25	112	55-621-1	111
40-710											

CALRAD

Numerical Index

55 Series

55-624-HDTV-12	113	55-633-6	125	55-660-100	129	55-741G-6	119	55-787A-25	135	55-852-3	131
55-624-HDTV-25	113	55-634-12	125	55-660-25	129	55-742	119	55-787A-50	135	55-852RR	131
55-624-HDTV-3	113	55-634-25	125	55-660-50	129	55-742-1.5	119	55-787A-6	135	55-852RT	131
55-624-HDTV-35	113	55-634-3	125	55-661-10	129	55-742-3	119	55-787A-75	135	55-853	131
55-624-HDTV-50	113	55-634-6	125	55-661-100	129	55-742-6	119	55-788-1	107, 134	55-853G-6	131
55-624-HDTV-6	113	55-635-12	125	55-661-25	129	55-742F-P	119	55-788-2	134	55-853RR	131
55-625-10	113	55-635-25	125	55-661-50	129	55-743	119	55-788-3	134	55-853RT	131
55-625-12	113	55-635-3	125	55-670-10	129	55-743-1	119	55-788-6-INCH10	134	55-854	131
55-625-15	113	55-635-6	125	55-670-18	129	55-743-10	119	55-788A	107, 134	55-854A	131
55-625-20	113	55-636-HS-1.3-10	115	55-670-25	129	55-743-3	119	55-788B	107, 134	55-854G	131
55-625-25	113	55-636-HS-1.3-3	115	55-675-15	129	55-744	119	55-790	127	55-856	131
55-625-3	113	55-636-HS-1.3-6	115	55-675-20	129	55-744-5	119	55-790-PS-BK	127	55-857	131
55-625-35	113	55-637-HS-1	115	55-675-25	129	55-750G	122	55-790-PS-WH	127	55-858	131
55-625-50	113	55-637-HS-1.5	115	55-700-10	123	55-751G	122	55-790-WH	127	55-859	131
55-625-6	113	55-637-HS-10	115	55-700-10-WH	123	55-753G	122	55-791	127	55-860	122
55-625-HDTV-10	113	55-637-HS-12	115	55-700-12	123	55-754G	122	55-791-PS-BK	127	55-862-12	124
55-625-HDTV-12	113	55-637-HS-15	115	55-700-12-WH	123	55-755G	122	55-791-PS-WH	127	55-862-3	124
55-625-HDTV-15	113	55-637-HS-20	115	55-700-15	123	55-760G	129	55-791-WH	127	55-862-6	124
55-625-HDTV-25	113	55-637-HS-25	115	55-700-15-WH	123	55-761G	129	55-792	127	55-862B	136
55-625-HDTV-3	113	55-637-HS-30	115	55-700-20	123	55-763G	129	55-792-PS-BK	127	55-862B-1.5	124
55-625-HDTV-35	113	55-637-HS-35	115	55-700-20-WH	123	55-764G	129	55-792-PS-WH	127	55-862B-12	124
55-625-HDTV-50	113	55-637-HS-6	115	55-700-25	123	55-765G	129	55-792-WH	127	55-862B-15	124
55-625-HDTV-6	113	55-639	115	55-700-25-WH	123	55-770G-1	118	55-793	127	55-862B-20	124
55-625D-10	113	55-640-1.5	125	55-700-250-WH	123	55-770G-10	118	55-793-PS-BK	127	55-862B-25	124
55-625D-10-WH	113	55-640-100	125	55-700-3	123	55-770G-100	118	55-793-PS-WH	127	55-862B-250	124
55-625D-12	113	55-640-12	125	55-700-6	123	55-770G-15	118	55-793-WH	127	55-862B-3	124
55-625D-12-WH	113	55-640-25	125	55-700-6-WH	123	55-770G-25	118	55-794	127	55-862B-50	124
55-625D-15	113	55-640-3	125	55-705-1	123	55-770G-30	118	55-794-PS-BK	127	55-862B-6	124
55-625D-20	113	55-640-50	125	55-705-10	123	55-770G-50	118	55-794-PS-WH	127	55-862B-75	124
55-625D-25	113	55-640-6	125	55-705-12	123	55-770G-6	118	55-794-WH	127	55-863B-12	124
55-625D-25-WH	113	55-640-75	125	55-705-15	123	55-770G-75	118	55-795	127	55-863B-3	124
55-625D-3	113	55-641-1.5	125	55-705-20	123	55-770G-100	118	55-795-PS-BK	127	55-863B-6	124
55-625D-3-WH	113	55-641-100	125	55-705-25	123	55-770G-150	118	55-795-PS-WH	127	55-864B-12	124
55-625D-35	113	55-641-12	125	55-705-250	123	55-770G-25	118	55-795-WH	127	55-864B-3	124
55-625D-50	113	55-641-25	125	55-705-30	123	55-770G-30	118	55-796	127	55-864B-6	124
55-625D-6	113	55-641-3	125	55-705-330	123	55-770G-3	118	55-796-PS-BK	127	55-865	123
55-625D-6-WH	113	55-641-50	125	55-705-500	123	55-770G-6	118	55-796-PS-WH	127	55-866-1	111
55-625D-HDTV-10	113	55-641-6	125	55-705-BK-250	123	55-770G-12	118	55-797	127	55-866-10	111
55-625D-HDTV-12	113	55-641-75	125	55-705-6	123	55-770G-15	118	55-797-PS-BK	127	55-866-100	111
55-625D-HDTV-15	113	55-642-1.5	125	55-710-10	121	55-770G-25	118	55-797-PS-WH	127	55-866-15	111
55-625D-HDTV-25	113	55-642-100	125	55-710-12	121	55-770G-50	118	55-797-W	127	55-866-20	111
55-625D-HDTV-3	113	55-642-12	125	55-710-15	121	55-770G-6	118	55-798	127	55-866-25	111
55-625D-HDTV-35	113	55-642-25	125	55-710-18	121	55-770G-10	118	55-800G	122	55-866-3	111
55-625D-HDTV-50	113	55-642-3	125	55-710-20	121	55-770G-15	118	55-802G	122	55-866-35	111
55-625D-HDTV-6	113	55-642-50	125	55-710-25	121	55-770G-25	118	55-803G	122	55-866-50	111
55-626-10-WH	114	55-642-6	125	55-710-30	121	55-771G-12	118	55-806G	122	55-866-6	111
55-626-12-WH	114	55-642-75	125	55-710-330	121	55-771G-25	118	55-808G	122	55-866-RCA-1	111
55-626-15-WH	114	55-643A-HS-1	114	55-710-6	121	55-771G-30	118	55-809G	122	55-866-RCA-12	111
55-626-25-WH	114	55-643A-HS-10	114	55-710-12	121	55-771G-6	118	55-812G	122	55-866-RCA-15	111
55-626-3-WH	114	55-643A-HS-12	114	55-710-15	121	55-771G-6	118	55-814G	122	55-866-RCA-20	111
55-626-6-WH	114	55-643A-HS-15	114	55-710-18	121	55-771G-12	118	55-815G	122	55-866-RCA-25	111
55-626-HD-HS-50	114	55-643A-HS-3	114	55-710-20	121	55-771G-15	118	55-818G	122	55-866-RCA-3	111
55-626-HD-HS-75	114	55-643A-HS-6	114	55-710-25	121	55-771G-18	118	55-820G	122	55-866-RCA-35	111
55-626-HD-HS-100	114	55-643A-HS-12	114	55-710-30	121	55-771G-25	118	55-821G	122	55-866-RCA-50	111
55-626A	114	55-643B-HS-1	114	55-715-10	121	55-771G-30	118	55-830	134	55-866-RCA-6	111
55-626A-50	114	55-643B-HS-10	114	55-715-12	121	55-771G-330	118	55-831	134	55-866B	136
55-627-1	115	55-643B-HS-12	114	55-715-15	121	55-771G-6	118	55-833	133	55-866F-10	111
55-627-10	115	55-643B-HS-15	114	55-715-20	121	55-771G-12	118	55-838	133	55-866F-12	111
55-627-12	115	55-643B-HS-15	114	55-715-25	121	55-771G-15	118	55-838-RT	133	55-866F-25	111
55-627-15	115	55-643B-HS-3	114	55-715-30	121	55-771G-18	118	55-839	133	55-866F-3	111
55-627-20	115	55-643B-HS-6	114	55-715-50	121	55-771G-25	118	55-839B-3	133	55-866F-6	111
55-627-25	115	55-644A-HS-1	114	55-715-500	121	55-772G-50	118	55-840	128	55-866F-12	133
55-627-3	115	55-644A-HS-10	114	55-715-6	121	55-772G-6	118	55-840-100	128	55-866F-15	111
55-627-35	115	55-644A-HS-12	114	55-715-BK-500	121	55-772G-75	118	55-840-1000	128	55-866F-25	111
55-627-50	115	55-644A-HS-15	114	55-716-10	121	55-772G-10	118	55-840-25	128	55-866F-3	111
55-627-6	115	55-644A-HS-2	114	55-716-12	121	55-772G-15	118	55-840-50	128	55-866F-6	111
55-628-10	115	55-644A-HS-3	114	55-716-15	121	55-772G-25	118	55-840-100	128	55-866F-12	133
55-628-12	115	55-644A-HS-6	114	55-716-20	121	55-772G-30	118	55-840-1000	128	55-866F-15	111
55-628-15	115	55-644B-HS-1	114	55-716-25	121	55-772G-3	118	55-840-25	128	55-866F-25	111
55-628-25	115	55-644B-HS-10	114	55-716-30	121	55-772G-6	118	55-840-50	128	55-866F-3	111
55-628-3	115	55-644B-HS-15	114	55-716-50	121	55-772G-10	118	55-840-100	128	55-866F-6	111
55-628-35	115	55-644B-HS-2	114	55-716-6	121	55-772G-15	118	55-840-1000	128	55-866F-12	133
55-628-50	115	55-644B-HS-3	114	55-716-12	121	55-772G-25	118	55-840-25	128	55-866F-15	111
55-628-6	115	55-644B-HS-6	114	55-716-15	121	55-772G-30	118	55-840-50	128	55-866F-25	111
55-630-100	125	55-644B-HS-12	114	55-716-20	121	55-772G-3	118	55-840-100	128	55-866F-3	111
55-630-12	125	55-644B-HS-15	114	55-716-25	121	55-772G-6	118	55-840-1000	128	55-866F-6	111
55-630-25	125	55-644B-HS-2	114	55-716-30	121	55-772G-10	118	55-840-25	128	55-866F-12	133
55-630-3	125	55-644B-HS-3	114	55-716-50	121	55-772G-15	118	55-840-50	128	55-866F-15	111
55-630-50	125	55-644B-HS-6	114	55-716-6	121	55-772G-25	118	55-840-100	128	55-866F-25	111
55-630-6	125	55-644B-HS-12	114	55-716-12	121	55-772G-30	118	55-840-1000	128	55-866F-3	111
55-630-75	125	55-644B-HS-15	114	55-716-15	121	55-772G-6	118	55-840-25	128	55-866F-6	111
55-631-100	125	55-644B-HS-2	114	55-716-20	121	55-772G-10	118	55-840-50	128	55-866F-12	133
55-631-12	125	55-644B-HS-3	114	55-716-25	121	55-772G-15	118	55-840-100	128	55-866F-15	111
55-631-25	125	55-644B-HS-6	114	55-716-30	121	55-772G-25	118	55-840-1000	128	55-866F-25	111
55-631-3	125	55-644B-HS-12	114	55-716-50	121	55-772G-30	118	55-840-25	128	55-866F-3	111
55-631-50	125	55-644B-HS-15	114	55-716-6	121	55-772G-6	118	55-840-50	128	55-866F-6	111
55-631-6	125	55-644B-HS-2	114	55-716-12	121	55-772G-10	118	55-840-100	128	55-866F-12	133
55-631-75	125	55-644B-HS-3	114	55-716-15	121	55-772G-15	118	55-840-1000	12		

CALRAD

Numerical Index

55 Series to 72 Series

55-871A-10	116	55-897-2	132	55-966	122	70-395-25	145	70-497R	146	72-102-WH-E90	148
55-871A-10-WH	116	55-897-20	132	55-967	123	70-396	147	70-497R-UL	146	72-102-YL-E	148
55-871A-12	116	55-897-25	132	55-969	130	70-397-BK	147	70-497R-25	146	72-102-YL-E90	148
55-871A-12-WH	116	55-897-3	132	55-970	131	70-397-IV	147	70-497R-100	146	72-103-AL-E	148
55-871A-25	116	55-897-4	132	55-971	130	70-397-SL	147	70-498	144	72-103-BK-E	148
55-871A-25-WH	116	55-897-50	132	55-972	134	70-397-W	147	70-498R-25	146	72-103-BU-E	148
55-871A-250-BK	116	55-897-6	132	55-973	129	70-402	143	70-498R-100	146	72-103-GN-E	148
55-871A-3	116	55-897B	136	55-974-10	131	70-402-W	143	70-499	146	72-103-IV-E	148
55-871A-3-WH	116	55-897G-15	132	55-974-3	131	70-403-AL	141	70-499R	146	72-103-OR-E	148
55-871A-35	116	55-897G-RT-6	132	55-974-6	131	70-403-ALS	141	70-499RS-UL	146	72-103-RD-E	148
55-871A-35-WH	116	55-897RT-6	132	55-975	134	70-403-BR	141	70-505	146	72-103-WH-E	148
55-871A-50	116	55-898	132	55-976	131	70-403-S	141	70-508	146	72-103-YL-E	148
55-871A-50-WH	116	55-899-1	133	55-976-RT	131	70-403-WS	141	70-509	146	72-104-BK	150
55-871A-6	116	55-899-10	133	55-978	131	70-404-W	141	70-510	146	72-104-BU	150
55-871A-6-WH	116	55-899-12	133	55-978-RT	131	70-404-S	141	70-511	146	72-104-GN	150
55-871F-12	116	55-899-25	133	55-979	123	70-404-WS	141	70-512	145	72-104-GY	150
55-871F-25	116	55-899-3	133	55-980	144	70-405	144	70-513	145	72-104-IV	150
55-871F-6	116	55-899-6	133	55-981	122	70-405-W	144	70-514R	146	72-104-OR	150
55-872-12	116	55-902	55, 133	55-982	122	70-406	147	70-516	146	72-104-RD	150
55-872-15	116	55-904	134	55-983	122	70-406-50	147	70-521	143	72-104-WH	150
55-872-20	116	55-906	134	55-984	122	70-407	144	70-530-S	141	72-104-YL	150
55-872-25	116	55-906A	134	55-985	123	70-407-D	144	70-530-W	141	72-105-BK	151
55-872-250	116	55-908	134	55-986	131	70-408	144	70-530-WS	141	72-105-BU	151
55-872-3	116	55-908A	134	55-987	130	70-408-W	144	70-531-S	141	72-105-IV	151
55-872-35	116	55-909	132	55-988	124	70-410-ALS	141	70-531-W	141	72-105-OR	151
55-872-50	116	55-910	122	55-988-6	124	70-410-ID	141	70-531-WS	141	72-105-RD	151
55-872-6	116	55-911	134	55-989	124	70-410-S	141	70-532	144	72-105-WH	151
55-873-BNC-12	111	55-912	130	55-990	124	70-410-WD	141	70-532-D	144	72-105-YL	151
55-873-BNC-20	111	55-913	130	55-991	124	70-410-WS	141	70-534-ALS	141	72-106-WH-E	148
55-873-BNC-25	111	55-914-10	130	55-996	55, 134	70-411	143	70-534-ID	141	72-107-WH	151
55-873-BNC-3	111	55-914-3	130	55-997	133	70-411-W	143	70-534-S	141	72-108-WH	151
55-873-BNC-6	111	55-914-6	130	55-998	124	70-413	143	70-534-W	141	72-109	151
55-873-RCA-12	111	55-915	122	55-999	124	70-413-W	143	70-534-WD	141	72-109-CAT6	151
55-873-RCA-20	111	55-916	122	60 SERIES		70-414	143	70-534-WS	141	72-110-1-BK	152
55-873-RCA-25	111	55-916-100	122	60-118	138	70-414-W	143	70-535	141	72-110-1-BU	152
55-873-RCA-3	111	55-916-50	122	60-121	138	70-415	146	70-536	141	72-110-1-GN	152
55-873-RCA-35	111	55-918	122	60-122	138	70-415-W	146	70-537	141	72-110-1-GY	152
55-873-RCA-50	111	55-919	122	60-125	138	70-416-8	147	70-539	144	72-110-1-RD	152
55-873-RCA-6	111	55-920-100	132	60-127	138	70-416-SL	147	70-540-BK	147	72-110-1-WH	152
55-874	126	55-920-12	132	60-129	138	70-416-BK	147	70-540-IV	147	72-110-1-YL	152
55-875-12	126	55-920-25	132	60-130	138	70-416-IV	147	70-540-SL	147	72-110-10-BK	152
55-875-15	126	55-920-50	132	60-133	138	70-416-W	147	70-540-W	147	72-110-10-BU	152
55-875-20	126	55-920-6	132	60-134	138	70-417	144	70-541-BK	147	72-110-10-GN	152
55-875-3	126	55-921-10	132	60-136	138	70-418-IV	147	70-541-BK-1000	147	72-110-10-GY	152
55-875-6	126	55-921-12	132	60-137	138	70-419	146	70-541-IV	147	72-110-10-RD	152
55-876	126	55-921-15	132	60-140	138	70-419-W	146	70-541-IV-1000	147	72-110-10-YL	152
55-877-10	126	55-921-25	132	60-142	138	70-423	144	70-541-SL	147	72-110-100-BK	152
55-877-12	126	55-921-3	132	60-144	138	70-424	144	70-541-SL-1000	147	72-110-100-BU	152
55-877-15	126	55-921-6	132	60-148	138	70-425	144	70-541-W	147	72-110-100-GN	152
55-877-20	126	55-922	131	60-149	138	70-426-S	141	70-541-W-1000	147	72-110-100-GY	152
55-877-25	126	55-922-RT	131	60-150	138	70-426-W	141	70-544-IV-100	147	72-110-100-RD	152
55-877-3	126	55-923	124	60-151	138	70-426-WS	141	70-544-IV-1000	147	72-110-100-YL	152
55-877-50	126	55-924	124	60-152	138	70-427	141	70-544-SL	147	72-110-14-BK	152
55-877-6	126	55-925	122	60-153	138	70-427-M	141	70-544-SL-1000	147	72-110-14-BU	152
55-877-75	126	55-926	122	60-154	138	70-427-W	141	70-547-IV-100	147	72-110-14-GN	152
55-877-8	126	55-927	122	60-155	138	70-428-IV	147	70-547-IV-1000	147	72-110-14-GY	152
55-877G	126	55-927-RT	122	60-156	138	70-428-W	147	70-547-SL-100	147	72-110-14-RD	152
55-878G-2	126	55-928	122	60-158	138	70-429-IV	147	70-547-SL-1000	147	72-110-14-YL	152
55-878-3	126	55-930	122	60-159	138	70-429-SL	147	70-550	146, 152	72-110-25-BK	152
55-878G-3	126	55-931	122	60-160	138	70-429-W	147	70-551	146	72-110-25-BU	152
55-879-12	126	55-932	122	60-161	138	70-430	147	70-552	141	72-110-25-GN	152
55-879-15	126	55-933	122	60-163	138	70-431	147	70-553A	34, 143	72-110-25-GY	152
55-879-2	126	55-934	122	60-165	138	70-432	147	70-554	144	72-110-25-RD	152
55-879-20	126	55-935	122	60-166	138	70-433	147	70-556-P	34, 143	72-110-25-YL	152
55-879-25	126	55-936-10	130	60-167	138	70-434	147	70-557-P	34, 143	72-110-3-BK	152
55-879-3	126	55-936-3	130	60-168	138	70-434-IV	147	70-558	34, 143	72-110-3-BU	152
55-879-50	126	55-936-6	130	60-169	138	70-435	147	70-559	34, 143	72-110-3-GN	152
55-879-6	126	55-937	132	60-171	138	70-440	147	70-564	143	72-110-3-GY	152
55-879G-6	126	55-938	132	60-172	138	70-441	147	70-568	34, 143	72-110-3-RD	152
55-880G-10	126	55-939	132	60-175	138	70-442	147	70-569	34, 143	72-110-3-WH	152
55-881G-20	126	55-940	132	60-180	138	70-443	146	70-570-ID	141	72-110-3-YL	152
55-882	127	55-941	132	60-181	138	70-444	146	70-570-WD	141	72-110-5-BK	152
55-882-1	127	55-942	132	60-182	138	70-445	147	70-571-ID	141	72-110-5-BU	152
55-882-2	127	55-943	132	60-187	138	70-446	147	70-585	147	72-110-5-GN	152
55-882-2-PO	126	55-943-50	132	60-188	138	70-447	147	70-650	145	72-110-5-GY	152
55-882-PO	126	55-944-2.5	133	60-190	138	70-448	147	70-651	145	72-110-5-RD	152
55-883-PO	126	55-944-3.5	133	65 SERIES		70-449	147	72 SERIES		72-110-5-WH	152
55-884-PO	126	55-944-RT	133	65-263	139	70-450	147	72-100-AL	148	72-110-5-YL	152
55-882-W	127	55-946	133	65-264	139	70-451	147	72-100-BK	148	72-110-50-BK	152
55-883	127	55-946-RT	133	65-266	139	70-452	147	72-100-IV	148	72-110-50-BU	152
55-883-W	127	55-947	132	65-270	139	70-453	147	72-100-WH	148	72-110-50-GN	152
55-884	127	55-948	130	65-295A	140	70-454	147	72-100T	147	72-110-50-GY	152
55-884-W	127	55-949	132	65-308	140	70-460	147	72-101-BK	148	72-110-50-RD	152
55-885	127	55-950	131	70 SERIES		70-461	147	72-101-IV	148	72-110-50-YL	152
55-885-W	127	70-392-100	145	70-392-100	145	70-462-50	147	72-101-WH	148	72-110-7-BK	152
55-886	127	70-392-1000	145	70-392-25	145	70-465	147	72-102-AL-E	148	72-110-7-BU	152
55-886-W	127	70-392-25	145	70-392J-1000	145	70-465-50	147	72-102-AL-E90	148	72-110-7-GN	152
55-887	127	70-392J-100	145	70-392J-25	145	70-466	147	72-102-BK-E	148	72-110-7-RD	152
55-887-W	127	70-392J-1000	145	70-393-100	145	70-467	147	72-102-BK-E90	148	72-110-7-YL	152
55-888	127	70-393-1000	145	70-393-25	145	70-480	143	72-102-BU-E	148	72-110-7-BK	153
55-888-W	127	70-393-25	145	70-394-1000	145	70-487	144	72-102-BU-E90	148	72-111-10-BK	153
55-890-12	126	70-393-1000	145	70-394-1000	145	70-489	144	72-102-GN-E	148	72-111-10-BU	153
55-890-25	126	70-393-25	145	70-394-1000	145	70-491	144	72-102-GN-E90	148	72-111-10-GN	153
55-											

72 Series to 75 Series

Numerical Index

72-111-100-GY	153	72-172	153	72-300-BK	148	72-400-IV	148	75-526	166	75-559-ST	166
72-111-100-RD	153	72-173	153	72-300-BU	148	72-400-OR	148	75-527	166	75-559-ST-75	166
72-111-100-WH	153	72-190-10	156	72-300-GN	148	72-400-RD	148	75-528	163	75-560	160
72-111-100-YL	153	72-190-6	156	72-300-IV	148	72-400-WH	148	75-528G	163	75-561	166
72-111-15-BK	153	72-191-6	155	72-300-OR	148	72-400-YL	148	75-529	162	75-562	167
72-111-15-GY	153	72-191-10	155	72-300-RD	148	70-401-WH	148	75-530	163	75-563	167
72-111-25-BK	153	72-191-15	155	72-300-WH	148	72-497R-100	150	75-530G	163	75-564	167
72-111-25-BU	153	72-193	154	72-300-YL	148	72-497R-25	150	75-531	163	75-565	163
72-111-25-GN	153	72-194-6	156	72-300G-BK	148	72-498R-100	150	75-531G	163	75-565-PO	166
72-111-25-GY	153	72-194-10	156	72-300G-BU	148	72-498R-25	150	75-532	163	75-566	163
72-111-25-RD	153	72-195-10	156	72-300G-GN	148	72-FIR	154	75-532G	163	75-567	163
72-111-25-WH	153	72-195-6	156	72-300G-IV	148	72-UC-320	154	75-533	162	75-568	163
72-111-25-YL	153	72-196-10	156	72-300G-OR	148	75 SERIES		75-533F-PS	164	75-568HQ	163
72-111-3-BK	153	72-196-6	156	72-300G-RD	148	75-R21-RD	165	75-533FG-PS	164	75-569	160
72-111-3-BU	153	72-205-BK	150	72-300G-WH	148	75-R21-WH	165	75-533G	162	75-570	169
72-111-3-GN	153	72-205-BU	150	72-300G-YL	148	75-R21-YL	165	75-533G-PS	164	75-571	169
72-111-3-GY	153	72-205-GN	150	72-304-6-BK	149	75-450	161	75-533G-PS-BNC	164	75-572	169
72-111-3-RD	153	72-205-IV	150	72-304-6-BU	149	75-451	161	75-533G-PSBNCRA	164	75-573	169
72-111-3-WH	153	72-205-OR	150	72-304-6-GN	149	75-452	161	75-533G-PS-PO	164	75-574	169
72-111-3-YL	153	72-205-PU	150	72-304-6-IV	149	75-452F-3	161	75-533G-PS-RA	164	75-575	169
72-111-5-BK	153	72-205-RD	150	72-304-6-OR	149	75-452F-4	161	75-533G-PS-RCA	164	75-576	169
72-111-5-BU	153	72-205-WH	150	72-304-6-PU	149	75-452F-5	161	75-533G-PSRCARA	164	75-577	169
72-111-5-GN	153	72-205-YL	150	72-304-6-RD	149	75-452F-6	161	75-533-PS	164	75-579	168
72-111-5-GY	153	72-210-AL	149	72-304-6-WH	149	75-453	161	75-533-PS-BNC	164	75-580	168
72-111-5-RD	153	72-210-IV	149	72-304-6-YL	149	75-454	161	75-533-PS-BNCRA	164	75-583	168
72-111-5-WH	153	72-210-WH	149	72-304G-6-BK	149	75-469	161	75-533-PS-PO	164	75-584	168
72-111-5-YL	153	72-211-IV	149	72-304G-6-BU	149	75-471	161	75-533-PS-RA	164	75-585	168
72-111-50-BK	153	72-211-WH	149	72-304G-6-GN	149	75-472	161	75-533-PS-RCA162	164	75-586	168
72-111-50-BU	153	72-213-AL	151	72-304G-6-IV	149	75-479	159	75-533-PS-RCARA	164	75-587	168
72-111-50-GN	153	72-213-IV	151	72-304G-6-OR	149	75-480	157	75-533-SN59	162	75-588	168
72-111-50-GY	153	72-213-WH	151	72-304G-6-PU	149	75-480-3	157	75-533-SN6	162	75-589	168
72-111-50-RD	153	72-217-IV	151	72-304G-6-RD	149	75-481	157	75-534	162	75-590	168
72-111-50-WH	153	72-217-WH	151	72-304G-6-WH	149	75-481-3	157	75-534F-PS	164	75-591	168
72-111-50-YL	153	72-225	156	72-304G-6-YL	149	75-486	160	75-534FG-PS	164	75-592	168
72-111-7-BK	153	72-226-12	156	72-304-BK	149	75-488	160	75-534G	162	75-593	168
72-111-7-BU	153	72-226-16	156	72-304-BU	149	75-489-ID	141, 162	75-534G-PL	162	75-594	168
72-111-7-GN	153	72-226-24	156	72-304-GN	149	75-489-IV	141, 162	75-534G-PS	164	75-595	168
72-111-7-GY	153	72-226-48	156	72-304-IV	149	75-489-W	141, 162	75-534G-PS-BNC	164	75-596	168
72-111-7-RD	153	72-230-1	151	72-304-OR	149	75-489-WD	141, 162	75-534G-PSBNCRA	164	75-598	160, 164
72-111-7-WH	153	72-230-1-AL	151	72-304-PU	149	75-489-IV-2	141, 162	75-534G-PS-PO	164	75-599A	160, 164
72-111-7-YL	153	72-230-1-IV	151	72-304-RD	149	75-489-WH-2141	162	75-534G-PS-RA	164	75-600	167
72-111-75-BK	153	72-230-2	151	72-304-WH	149	75-491	157	75-534G-PS-RCA	162	75-600-1	167
72-111-75-BU	153	72-230-2-AL	151	72-304-YL	149	75-493	141, 161	75-534G-PSRCARA	164	75-601	167
72-111-75-GN	153	72-230-2-IV	151	72-304G-BK	149	75-493-2	141, 161	75-534-PL	162	75-601-1	167
72-111-75-GY	153	72-230-3	151	72-304G-BU	149	75-493-ID	141, 162	75-534-PS	164	75-602	167
72-111-75-RD	153	72-230-3-AL	151	72-304G-GN	149	75-493-SS	141, 162	75-534-PS-BNC164	166	75-602-1	167
72-111-75-WH	153	72-230-3-IV	151	72-304G-IV	149	75-493-W	141, 161	75-534-PS-BNCRA	164	75-604	167
72-111-75-YL	153	72-230-4	151	72-304G-OR	149	75-493-WD	141, 162	75-534-PS-PO	164	75-605-BK-100	153
72-119-4	156	72-230-4-AL	151	72-304G-PU	149	75-493-WH-2141	161	75-534-PS-RA	164	75-605-BK-25	157
72-119-6	156	72-230-4-IV	151	72-304G-RD	149	75-494-IV	161	75-534-PS-RCA162	164	75-605-W-100	157
72-120-10	137, 156	72-230-6	151	72-304G-WH	149	75-494-W	161	75-534-PS-RCARA	164	75-605-W-25	157
72-120-12	156	72-230-6-AL	151	72-304G-YL	149	75-496	160	75-534-PSRCARA-174	164	75-606-BK-100	157
72-120-15	137, 156	72-230-6-IV	151	72-306	148	75-498	157	75-534Q	162	75-606-BK-25	157
72-120-6	137, 156	72-231-1	151	72-305-E	148	75-498-BK	157	75-534Q-PS	164	75-606-W-100	157
72-120K	150	72-231-2	151	72-307-BK	149	75-498-D	157	75-534Q-PS-BNC	164	75-606-W-25	157
72-120K-S	150	72-231-3	151	72-307-BU	149	75-498-D-BK	157	75-534Q-PS-RCA	162	75-607	165
72-121-10	137, 156	72-231-4	151	72-307-GN	149	75-498-Q	157	75-534-QS	162	75-608	162
72-121-12	137, 156	72-233-1	151	72-307-IV	149	75-499	157	75-534-SN6	162	75-608G	162
72-121-15	137, 156	72-233-1-IV	151	72-307-RD	149	75-500	157	75-534-WP	162	75-608S-RG-59	162
72-121-6	137, 156	72-233-2	151	72-307-WH	149	75-502	161	75-535	163	75-608S-RG6	162
72-122-10	137, 156	72-233-2-IV	151	72-307-YL	149	75-503	157	75-535-2	163	75-609	165
72-122-12	137, 156	72-233-3	151	72-308-BK	148	75-504	159	75-535-PO	163	75-609-TFE	165
72-122-15	137, 156	72-233-3-IV	151	72-308-BU	148	75-505	157	75-536	167	75-610	165
72-122-6	137, 156	72-233-4	151	72-308-GN	148	75-505G	157	75-536-RG58	167	75-611	165
72-122K	150	72-233-4-IV	151	72-308-IV	148	75-507	158	75-537	162	75-612	165
72-122K-S	150	72-233-6	151	72-308-RD	148	75-508	157	75-537-RG6	162	75-613	165
72-123	156	72-233-6-IV	151	72-308-WH	148	75-508G	157	75-537G	162	75-614	165
72-124	156	72-234	152	72-306-YL	149	75-509	157	75-538	162	75-615	169
72-125-10	137, 156	72-236-WH	151	72-308G-BK	148	75-509G	157	75-538G	162	75-615-BK	169
72-125-12	156	72-239	152	72-308G-BU	148	75-510	162	75-539	163	75-616	169
72-125-15	137, 156	72-240	152	72-308G-GN	148	75-510-RG11	162	75-540	166	75-617	169
72-125-3	156	72-241	152	72-308G-IV	148	75-510G	162	75-541	166	75-618	169
72-125-6	137, 156	72-242	152	72-308G-RD	148	75-511	162	75-542	165	75-620	166
72-125K	150	72-244	152	72-308G-WH	148	75-511G	162	75-542G	165	75-621	166
72-125K-W	150	72-245	152	72-308G-YL	148	75-512	162	75-543	166	75-622	166
72-125K-S	150	72-246	152	72-310-BK	149	75-513	162	75-543G	166	75-623	166
72-125K-S-2	150	72-247	152	72-310-BU	149	75-514	167	75-544	167	75-624	166
72-126-10	137, 156	72-248	151	72-310-GN	149	75-515	167	75-545	167	75-625	163
72-126-12	156	72-250-BU	156	72-310-IV	149	75-516	167	75-546	167	75-626	166
72-126-15	137, 156	72-250-GY	156	72-310-RD	149	75-516G	167	75-546G	167	75-628	166
72-126-3	156	72-250-S	156	72-310-WH	149	75-517	166	75-547	167	75-628-50	166
72-126-6	137, 156	72-250-WH	156	72-311G	149	75-517G	166	75-547G	167	75-629	167
72-126K	150	72-251	156	72-312G	149	75-518	162	75-548	167	75-630	168
72-126K-S	150	72-252	154	72-313G	149	75-518G	162	75-548-S	167	75-631	168
72-127-10	137, 156	72-253	154	72-314G	149	75-519	163	75-548G	167	75-635A	163
72-127-15	137	72-254	154	72-320	149	75-520	163	75-549	165	75-635A-BK	163
72-127-3	156	72-255	154	72-320-BK	149	75-520-1/2	163	75-549G	165	75-635A-BU	163
72-127-6	137, 156	72-256	154	72-320-BU	149	75-520-1D	163	75-550	165	75-635A-GN	163
72-127-6-INCH	156	72-257	154	72-320-GN	149	75-520-2D	163	75-551	165	75-635A-RD	163
72-128	137, 155	72-258	154	72-320-IV	149	75-520DD-WH	163	75-552	166	75-635A-WH	163
72-128-26	137, 155	72-259	154	72-320-RD	149	75-520-WH	163	75-553	167	75-635A-YL	163
72-130	196	72-260-3	137, 154	72-32							

CALRAD

Numerical Index

75 Series to 99 Series

75-642	169	75-767	169	90-747	174	92-111	185	95-840	191
75-645	166	75-768	169	90-751	174	92-115	185	95-845	192
75-646	166	75-780-RG-174	164	90-755	174	92-116	185	95-846	192
75-650-BK-100	157	75-780-RG-58	164	90-756	175	92-120-BL	185	95-847B	191
75-650-BK-25	157	75-780-RG-59	164	90-757	175	92-120-GN	185	95-848	192
75-650-W-100	157	75-800G-50	165	90-757G	175	92-120-RD	185	95-850	193
75-650-W-25	157	75-800G-75	165	90-758	175	92-120-WH	185	95-869B	194
75-651-W-100	157	75-801G-50	165	90-758G	175	92-120-YL	185	95-875	194
75-651-W-25	157	75-801G-75	165	90-764	140, 173	92-125	185	95-882	193
75-652-W-100	157	75-802G-75	165	90-765	140, 173	92-152	186	95-884	193
75-652-W-25	157	75-803G-75	165	90-766	140, 173	92-152-2	186	95-888	193
75-653-W-100	157	75-804	161	90-767	140, 173	92-153	186	95-889	193
75-653-W-25	157	80 SERIES		90-768	140, 173	92-160	186	95-890	193
75-654-W-100	157	80-403	171	90-770	140, 173	92-161	186	95-893	192
75-654-W-25	157	80-404	171	90-771	140, 173	92-163	186	95-894	192
75-655-W-100	157	80-405	170	90-771-BK	140, 173	92-164	186	95-898	190
75-655-W-20	157	80-407	171	90-771-RD	140, 173	92-165	186	95-899	190
75-656-BK-100	157	80-408	171	90-772-2.5	173	92-166	186	95-900	193
75-656-BK-25	157	80-410	171	90-772-4	173	92-167	186	95-902	193
75-656-W-100	157	80-411	171	90-772-6.5	173	92-169	186	95-904	191
75-656-W-25	157	80-412	171	90-772-8	173	92-170-KIT	187	95-906	190
75-657-BK-100	157	80-413	11, 171	90-772M	173	92-200	184	95-908	192
75-657-BK-25	157	80-505	11, 170	90-773	173	92-201	184	95-909	192
75-679	166	80-506	11, 170	90-774	173	92-203-BK	184	95-911	193
75-680	165	80-507	11, 170	90-775	173	92-203-BU	184	95-914	190
75-681	165	80-508	170	90-777	173	92-203-GY	184	95-920	190
75-682	165	80-510	170	90-779	173	92-203-RD	184	95-923	192
75-683	165	80-566	145, 171	90-780	174	92-203-WH	184	95-925	194
75-684	165	80-574	170	90-781	140, 173	92-300	184	95-926	194
75-685	167	80-575-H	11, 170	90-783	174	92-301	184	95-927	194
75-686	165	80-575-L	11, 170	90-783-UL	174	92-322	184	95-950	193
75-687	165	80-575-M	11, 170	90-784	176	92-324	184	99 SERIES	
75-687-A	165	80-575-P	11, 170	90-785	176	92-325	184	95-960	189
75-688	167	85 SERIES		90-786	176	92-326	184	99-1218B	179
75-690	166	85-559	172	90-787	179	92-340	184	99-1218C	179
75-691	166	85-560	172	90-787-BU	179	92-341	184	99-1218F	179
75-692	167	85-561	172	90-787-GN	179	95 SERIES		99-1224B	179
75-693	166	85-565-ID	23, 172	90-787-WH	179	95-1038	189	99-1224F	179
75-694	167	85-565-WD	23, 172	90-794	176	95-1039	189	99-1236B	179
75-695	56, 167	85-567	172	90-795	176	95-1040	56, 189	99-1236C	179
75-696	166	85-569	172	90-796	176	95-1041	72, 189	99-1236F	179
75-696K-S	164	85-571	172	90-797	176	95-1044-BNC	56, 189	99-1258B	179
75-697	166	85-572	172	90-799	43, 175	95-1044-RCA	56, 189	99-1258F	179
75-698	163	85-574	172	90-800	43, 175	95-1045	189	99-1272F	179
75-699	167	85-575	172	90-803	177	95-1046	72, 189	99-3812B	179
75-705A	159	85-577	172	90-804	178	95-1062-BK	196	99-3812F	179
75-710	158	85-578	172	90-805	178	95-1062-BK-KIT	196	99-3818B	179
75-711	158	85-579	172	90-811	174	95-1062-BK-RS232	196	99-3818C	179
75-712	158	85-580	172	90-818	174	95-1062-WH	196	99-3818F	179
75-713-16	158	85-590	172	90-819	176	95-1062-WH-KIT	196	99-3824B	179
75-713-2	158	85-591	172	90-828	177	95-1062-WH-RS232	196	99-3824C	179
75-713-3	158	85-592	172	90-830	182	95-1140	55	99-3824F	179
75-713-4	158	85-593	172	90-831	182	95-1144	55	99-3836B	179
75-713-6	158	85-594	172	90-832	182	95-1145	55	99-3836C	179
75-713-8	158	85-595	172	90-833	182	95-1601	188	99-3836F	179
75-714-3	158	85-596	172	90-860	182	95-2020	195	99-3848B	179
75-715	158	85-597	172	90-861	182	95-2021	195	99-3858F	179
75-716	158	85-598	172	90-862	182	95-2024A	195	99-3872F	179
75-717	158	85-599	172	90-838	174	95-2025	195	99-7548B	179
75-720-10	159	85-660	172	90-842	176	95-2026	195	99-A10036B	179
75-720-12	159	85-663	172	90-843	176	95-403	190	99-A10048B	179
75-720-16	159	90 SERIES		90-844	177	95-405	190	99-A1224B	179
75-720-20	159	90-600	179	90-850	178	95-405-C	190	99-A1236B	179
75-720-3	159	90-600-S	179	90-853	178	95-455	189	99-A1248B	179
75-720-6	159	90-601	179	90-856	179	95-460	189	99-A3424B	179
75-720-8	159	90-602	179	90-867A	183	95-464	189	99-A3436B	179
75-724	161	90-604	179	90-868	183	95-470	188	99-A3448B	179
75-724-MS	161	90-605	181	90-880	176	95-600	188	99-A3472B	179
75-724-PO	161	90-606	180	90-881	176	95-601	188	99-A3824B	179
75-725	159	90-607	181	90-882	176	95-602	188	99-A3836B	179
75-726	159	90-608	181	90-883	176	95-702	194	99-A3848B	179
75-727-12	158	90-610	180	90-900	178	95-724A	191	99-A3872B	179
75-727-16	158	90-611	180	90-900R	178	95-770	196	99-A5836B	179
75-727-24	158	90-612	180	90-900T	178	95-770-SNAP	196	99-A5848B	179
75-728	160	90-613	180	90-903	178	95-771	196	99-F12F	179
75-729	160	90-614	180	90-905	177	95-772	196	99-F18F	179
75-730-2	159	90-615	180	90-906	177	95-773	196	99-F24F	179
75-730-4	159	90-616	180	90-908	177	95-777	197	99-F36F	179
75-731-2	159	90-617	180	90-912	177	95-780	198	99-F58F	179
75-731-4	159	90-617.6	181	90-913	183	95-781	198	99-F72F	179
75-735-IV	162	90-618	181	90-914	183	95-783	198	99-H3858F	179
75-735-W	162	90-618-RT	181	90-920	178	95-783-P	198		
75-736-IV	162	90-619	181	90-921	178	95-785	198		
75-736-W	162	90-620	180	90-923	178	95-786	198		
75-750-1	163	90-630-BK-100	183	90-924	178	95-788	198		
75-750-1/2-1	163	90-630-GY-100	183	90-925	178	95-790	196		
75-750-1/2-2	163	90-631-BK-100	183	90-926	178	95-791	196		
75-750-2	163	90-631-GY-100	183	90-927-12	177	95-792-GN	197		
75-750-3	163	90-632-BK-50	183	90-927-8	177	95-792-OR	197		
75-750G-1	163	90-632-GY-50	183	90-928-8	177	95-793	198		
75-750G-1/2-1	163	90-635-BK	183	90-930-A	177	95-794	198		
75-750G-1/2-2	163	90-635-BK-150	183	90-936	176	95-795	198		
75-750G-2	163	90-635-GY-150	183	90-937	176	95-795-UL	198		
75-755	162	90-701-XLR-RA	184	90-945	161	95-796	197		
75-756	162	90-702	184	90-1000	184	95-800	188		
75-760	169	90-730-BK	175	90-1000-BAT	184	95-801	188		
75-761	169	90-730-RD	175	92 SERIES		95-802	188		
75-762	169	90-732	174	92-100	185	95-820	192		
75-763	169	90-740	175	92-101	185	95-821	192		
75-764	169	90-741	175	92-102	185	95-823	193		
75-765	169	90-745	174	92-103	185	95-824	193		
75-766	169	90-746	174	92-110	185	95-830	194		

Alphabetical Index

AC OUTLET ACCESSORIES

AC Jacks, Plugs, Adapters	197-198
AC Outlet Strips	198
AC Surge Protectors AC, TV, Telephone	197

ADAPTERS

AC & DC Power	102-104
Audio	48-49, 51-55
Cigarette Lighter Jacks & Plugs	106, 179-181
Networking.....	148-150, 153
R.F.....	139-164
Telephone.....	118-123
Video	133-146
XLR.....	49

AMPLIFIERS

Audio and Public Address	194-195
HDMI Amplifiers.....	80

ANTENNAS & ACCESSORIES

F.M. Dipole	161
Splitters & Baluns	157-160
RF Switches.....	160
Telescoping	161

AUDIO ACCESSORIES

Adapters	7-8, 48-55
Audio Attenuator, Mixers & Preamps	10-11
Audio Switchers	70
Cleaning Accessories	170-171
Digital Amplifiers & Converters	11-12
Headphones	13-14
Isolation & Line Matching Transformers	6
RCA & BNC Patch Panels	11
Toslink Switcher, Converters & Amplifiers	12, 48
Toslink Adapters & Cables	48, 119-120
Wireless Microphones	1-2

BATTERY HOLDERS

173-174

BELLS

Alarm Bells.....	193
------------------	-----

BINDING POSTS

25, 175

CABLES

AC.....	107, 134- 135
Audio	111-136
BNC	125-126
Bulk Audio & Video	128, 136
Cigarette Lighter	179-181
Component Video.....	111, 116-117
Digital.....	114-119
DIN.....	134

DVI.....	113
Firewire	137, 156
HDMI	114-115
HDTV.....	112-118
Microphone	7-8
Midi	134
RF	125-127
RGB, RGB+HV	117
VGA, SVGA cables.....	110, 112-113
SVHS Cables.....	118
Speaker	123, 128
Telephone.....	147
Toslink	119-120
USB	137, 154, 156
Video	111-119, 121, 124-127

CABLE TIES

182

CB ACCESSORIES

Connectors	44, 167-168
Microphones	5
Speakers	17-18

CHASSIS BOXES

176

CLIP LEAD SETS

173

COMPUTER CONNECTORS

46-47, 50, 150

CONNECTORS

Audio Plugs & Jacks	35-46
Banana Plugs.....	42
Battery	173-174
BNC.....	165
Computer	46, 47, 50
Coaxial Power.....	42
DIN.....	44, 48
HDTV.....	36
Microphone.....	37-38, 41-45
RF.....	162-167
SVHS.....	38, 40-41
Telephone.....	144-146
Video	34-36, 38-41, 162-164
XLR.....	45-46

CONTROLS

Desk Top	24
L-Pads	25
Pontentiometers.....	20
Slide	21
Rotary	21
Designer Style Volume controls	22-23

Alphabetical Index

CONVERTERS\SCALERS	
Component\Composite.....	78
HDMI.....	78
DIN COUPLERS & CABLES	48
DRILL BITS	179
EARPHONES	14
ELECTRICAL TAPE	179
FOOT SWITCH	98
FUSE HOLDERS	174
HEADPHONES	
Junction Boxes	15
Monaural	13
Stereo	13-14
HDMI CABLE TESTER	139
HUM ELMINATORS	84
iPOD ACCESSORIES	101
IR DISTRIBUTION	186-187
KEY SWITCHES	57
KNOBS & DIALS	172
LED's (Light Emitting Diodes)	184-185
L.E.D DESKTOP & GOOSENECK LAMPS,	
FLASHLIGHTS	184-185
METERS	
Panel Type.....	138
Test Meters.....	139
MICROPHONES	
Cables.....	8
C.B.	5
Dynamic.....	3-5
Electret	3-4, 9
Goosenecks.....	9
Holders	10-11
Lapel.....	3-4
Miniature	3
Mixers	10-11
Paging.....	4
Stands	9-10
Wind Screens	5
Wireless.....	1-2
NETWORK CAT 5, CAT5e PRODUCTS	148-156
PANEL METERS	138
PILLOW SPEAKERS	17
PLUGS	
Audio	34-45
Computer	44-45
DIN	40-41
HDTV.....	34-36, 44-45, 139, 142
Microphone.....	41-44
Telephone.....	121-122
Video, RCA, SVHS, BNC.....	34-36, 38-41, 44-45, 141-144
POWER SUPPLIES	
AC.....	102-104
Alarm	192
DC	102-104
Inverters.....	108
Power Strips	198
Variable AC & DC	104, 106, 107
PRE-AMPLIFIERS	11-12, 147, 175
RELAYS	98, 194
RUBBER FEET	176
SCREW DRIVERS & TOOLS	176-177
SECURITY EQUIPMENT	
Control Panels	188
Camera Mounts & Housings.....	167-168
Cat 5 Video transmission adapters.....	189
Composite Video Balun	189
Digital Timers.....	191-192
Home & Office Security	188-193
Key Pads	192
Motion Detectors	189-190
Sirens & Bells	18, 193
Switches	99-100
Wireless Audio / Video transmitters	168-169, 170
SPEAKERS	
Attenuators	22-24
Background Music	18-19
Brackets.....	19
Grilles.....	17
Line Matching Transformers.....	6, 22-23, 105
Miniature	16
Outdoor.....	18-19
Public Address.....	19
Switchers	70
Weatherproof.....	18-19
Wire	123, 128

Alphabetical Index

SWITCHES

Audio.....	70
Alarm.....	99-100
Lighted.....	95
Magnetic.....	99-100
Push-Button.....	97-98
RF.....	160
Rocker.....	95
Slide.....	97
Speaker.....	70
Toggle.....	95-96
Toslink Fiber-Optic.....	48
VGA Switchers.....	90-91
Video.....	59-68

TELEPHONE ACCESSORIES

Adapters, Couplers.....	143-146
Cables & Wire.....	147
Jacks.....	143, 146
Plugs.....	146
Wall Plates.....	141
Wire.....	147

TERMINAL STRIPS.....151-152

TEST CLIPS & LEADS.....140,173

TEST METERS.....139

TOOLS.....146,152,161,164,176-179, 182, 183

TOUCHSCREENS.....196

TRANSFORMERS

Foreign Travel.....	104, 109
Line-Matching.....	105
Miniature Audio.....	105
Power.....	102-105
Power Inverters.....	108

TV ACCESSORIES.....157-160

UTILITY BOXES.....176

VIDEO ACCESSORIES

Cables.....	86-98, 100, 110-112
Component Video over Cat 5 baluns.....	26,63,72
Connectors & Adapters.....	35-37, 48, 50
Digital to Analog Converter.....	70
N Connectors.....	169
PAL Connectors & Adapters.....	168

Pattern Generators/HDTV.....	94
Splitters & Balun Transformers.....	57-159
SVHS to Composite Adapters.....	48
VGA, SVGA Cables.....	91-93
Video Converters, Switchers & Amplifiers.....	59-74
Video Over Cat 5 Baluns.....	26, 29-30, 63, 72, 77

VOLUME CONTROLS

Desktop.....	24, 70
Standard & Designer Style Volume Controls.....	21-23, 32

WALL MOUNT BRACKETS.....34

WIND SCREENS.....5

Calrad's Integrated Audio & Video Products

CATALOG 161

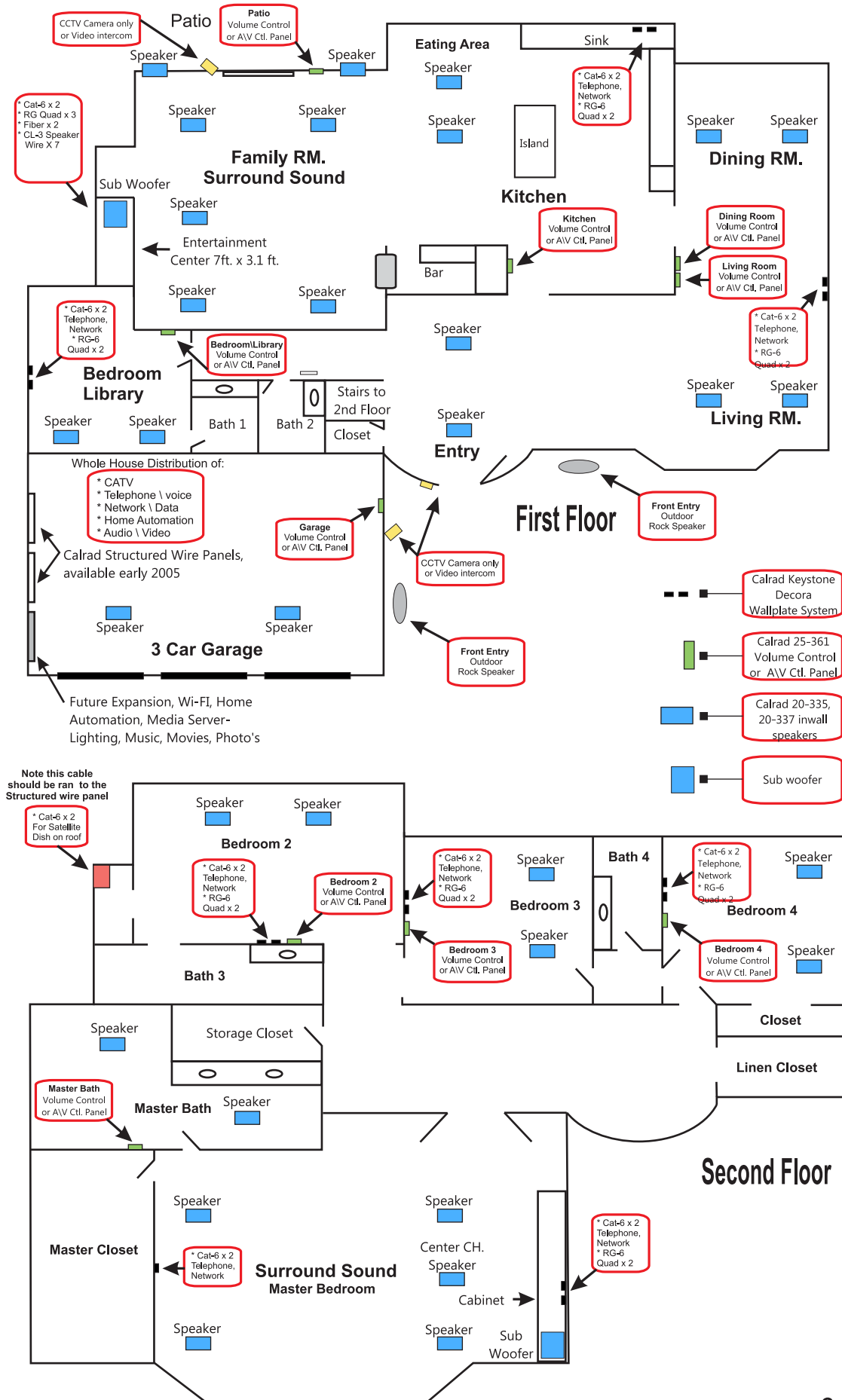

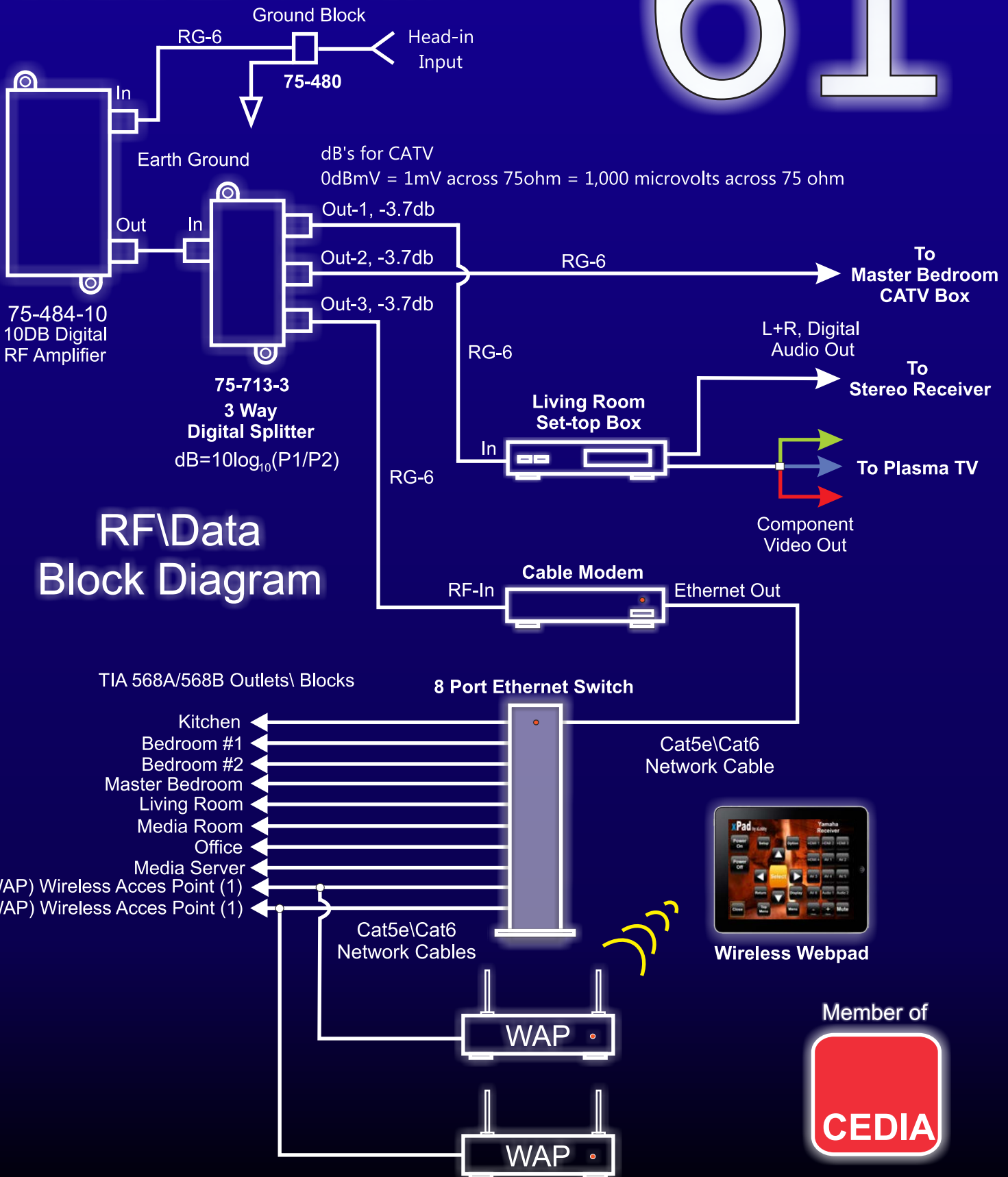

.....
CALRAD[®]
→ **ELECTRONICS**
Engineered Electronic Products

819 N. Highland Ave.
Los Angeles, CA 90038-3488
Information: (323) 465-2131
Toll Free: (800) 821-8536
Fax: (323) 465-3504
Website: www.calrad.com
E-Mail: calradelectronics@calrad.com

Business Hours: M-F 8:00am-4:30pm

Members of



Audio Video Solutions for over 55 Years



Catalog

61

\$5.00

Copyright 2011
Calrad Electronics

Distributed By:

www.calrad.com