

PRI-34 | Multifunction current monitoring relays in 1P - AC



EAN code
 PRI-34/1A: 8595188188968
 PRI-34/2A: 8595188182829
 PRI-34/5A: 8595188182836
 PRI-34/8A: 8595188188975
 PRI-34/16A: 8595188182843

Technical parameters		PRI-34
Supply		
Supply terminals:	A1 – A2	
Supply voltage:	AC/DC 24 – 240 V (AC 50-60 Hz)	
Consumption (max.):	3.8 VA/0.7 W	
Supply voltage tolerance:	-15 %; +10 %	
Measuring circuit		
Current range:	PRI-34/1A In - 1A PRI-34/2A In - 2A PRI-34/5A In - 5A PRI-34/8A In - 8A PRI-34/16A In - 16A (AC 50-60 Hz)	
Max. permanent current peak overload (1 s):	PRI-34/1A 2A/10A PRI-34/2A 4A/10A PRI-34/5A 10A/16A PRI-34/8A 16A/16A PRI-34/16A 17A/32A	
Upper level setting (Imax):	10 – 100 %In	
Lower level setting (Imin):	5 – 95 %In	
Time delay (d):	300 ms	
Time delay (t):	adjustable, 0.5 – 10 s	
Accuracy		
Setting accuracy (mech.):	5 %	
Repeat accuracy:	< 1 %	
Temperature dependency:	< 0.1 %/°C	
Limit values tolerance:	5 %	
Hysteresis (fault to OK):	5 % (function O1, U1, W) Imax – Imin (function O2, U2)	
Output		
Contact type:	1× changeover (AgNi)	
Current rating:	13 A/AC1; 1 HP 240 Vac, 1/2 HP 120 Vac; PD. B300	
Breaking capacity:	4000 VA/AC1, 384 W/DC1	
Switching voltage:	250 V AC/24 V DC	
Power dissipation (max.):	1.2 W	
Mechanical life:	10.000.000 ops.	
Electrical life (AC1):	100.000 ops.	
Other information		
Operating temperature:	-20 .. +55 °C (-4 .. 131 °F)	
Storage temperature:	-30 .. +70 °C (-22 .. 158 °F)	
Dielectric strength:	AC 4 kV (supply – output)	
Operating position:	any	
Mounting:	DIN rail EN 60715	
Protection degree:	IP40 front panel / IP20 terminals	
Oversvoltage category:	III.	
Pollution degree:	2	
Cross-wire section – solid/stranded with ferrule (mm²):	max. 1× 2.5, 2× 1.5/ max. 1× 2.5 (AWG 14)	
Dimensions:	90 × 17.6 × 64 mm (3.5" × 0.7" × 2.5")	
Weight:	60 g (2.15 oz)	
Standards:	EN 60255-1, EN 60255-26, EN 60255-27	

- It is used to monitor the value of alternating current, e.g.: motors, heating cables, lamps and other devices.
- Power supply and monitoring circuits are not galvanically isolated.
- Monitors current exceeding the upper current level (Imax) and falling below the lower current level (Imin) – according to the selected function.
- Smooth adjustment of both current levels.
- Adjustable time delay (to eliminate short-term current drops and spikes).
- Option to select functions with fault state memory (Latch).
- Measures true root mean square value of the current - TRUE RMS.
- Possibility to extend the current range using an external current transformer.

Description

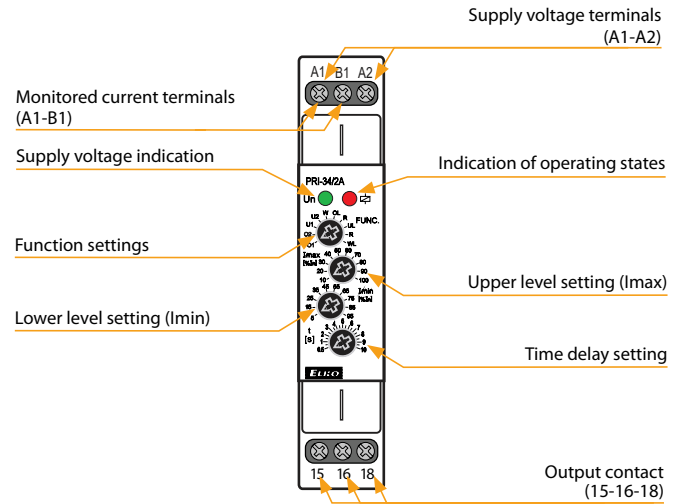

Connection

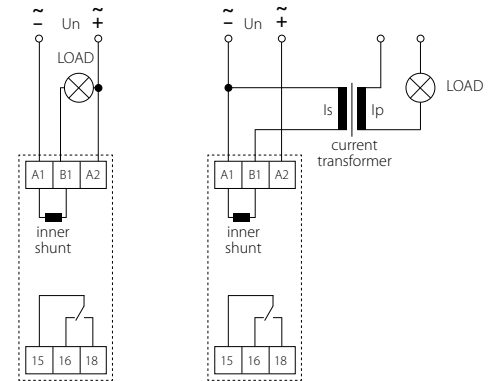

Indication of operating states

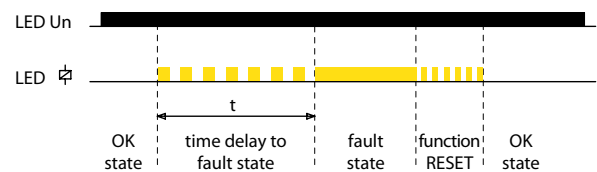

Function

O1 OVER (hysteresis 5%)

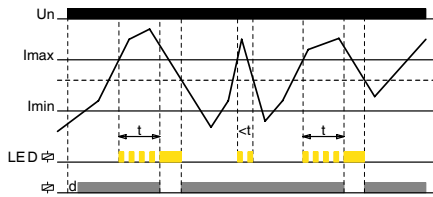

U1 UNDER (hysteresis 5%)

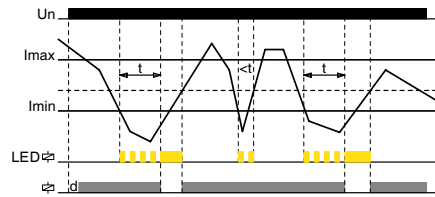

W WINDOW (hysteresis 5%)

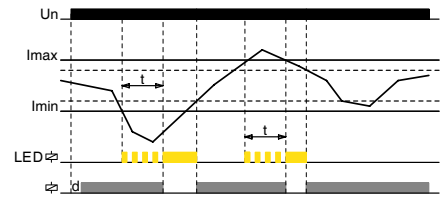

O2 OVER (hysteresis to I_{min})

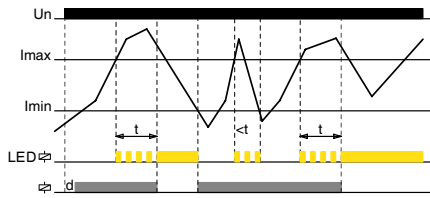

U2 UNDER (hysteresis to I_{max})

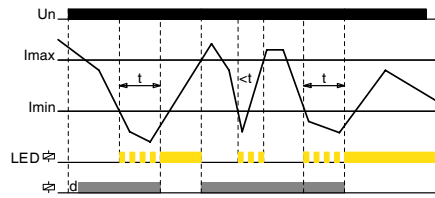

WL WINDOW + Latch

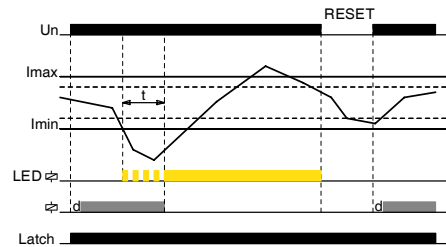

OL OVER + Latch

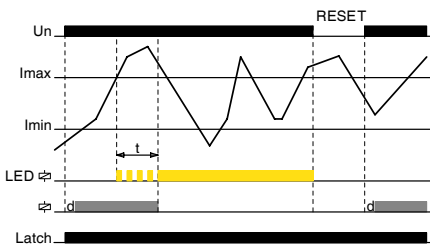

UL UNDER + Latch

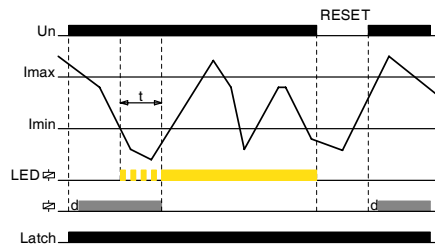

Graphs legend:

t = time delay to fault state

d = delay 0.3 s after connection of power supply (U_n)

OVER:

- If the value of the monitored current is lower than the set upper level „ I_{max} “, the output contact is closed. If the „ I_{max} “ is exceeded, the output contact will open after the set delay (fault state).
- If the current falls below the fixed hysteresis (function O1) or the set lower level „ I_{min} “ (function O2), the output contact will closes again.
- If the OL function (OVER + Latch) is selected, when the upper current level „ I_{max} “ is exceeded, the output contact remains open even when the current returns from the fault state.

Fault memory reset can be done in two ways:

- Short-term interruption of supply voltage.
- By setting the function switch to position R (RESET) or any function without memory fault.

The RESET state lasts for 3 s after switching the function switch from the R position to a function with memory fault (UL, OL, WL).

When moving to any other function from the R position, this delay does not apply.

UNDER:

- If the value of the monitored current is higher than the set lower level „ I_{min} “, the output contact is closed. When the current drops below the „ I_{min} “, output contact opens after the set delay (fault state).
- If the current exceeds the fixed hysteresis (function U1) or the set upper level „ I_{max} “ (function U2), the output contact closes again.
- If the UL function (UNDER + Latch) is selected, when the current drops below the lower level „ I_{min} “, the output contact remains open even when returning from the fault state. Fault memory reset can be done as in the previous case.

WINDOW:

- If the value of the monitored current is lower than upper level „ I_{max} “ and at the same time higher than lower level „ I_{min} “, the output contact in closed. If the „ I_{max} “ is exceeded or drops below the „ I_{min} “, output contact opens after the set delay (fault state).
- To return from the fault state, a fixed hysteresis is applied.
- If the WL function (WINDOW + Latch) is selected, the fault state is again stored in memory and output contact stays open, even when returning from the fault state. Fault memory reset can be done as in the previous cases.