

Input to output electric strength test up to 2 kVDC
Input voltage ranges:
18 to 36 and 36 to 75 VDC
Single and dual outputs of 5, 12, & 15 VDC

Features

- RoHS lead-solder-exempt compliant
- Wide input voltage ranges
- Rated to Basic Isolation
- Electrical isolation, single and dual outputs
- Immunity to IEC/EN 61000-4-2, -3, -4, and -8
- High efficiency (typ. 84%)
- Flex power: flexible load distribution
- No load and short-circuit proof
- High reliability and no derating
- Operating ambient temperature -40 to +71 °C
- Industrial and alternative pinouts
- DIL 24 case with 8.5 mm profile

Safety according to IEC/EN 60950, UL 1950



Description

The IMS6 Series of board-mountable 6 Watt DC-DC converters has been designed according to the latest industry requirements and standards. The converters are particularly suitable for use in mobile or stationary applications in transport, industry or telecommunications where variable input voltages or high transient voltages are prevalent.

Covering a total input voltage range from 18 VDC up to 75 VDC, with single and dual outputs from 5 VDC up to ±15 VDC with flexible load distribution on dual outputs.

The converters are designed and built according to the international safety standards IEC/EN 60950, UL 1950, CAN/CSA C22.2 No.950-95 and are UL marked.

A special feature is their small case size, DIL 24 with only an 8.5 mm profile. The circuit comprises integrated planar magnetics and all components are automatically assembled and solidly soldered onto a single PCB without any wire connections. Thanks to the rigid mechanical design, the converters withstand an extremely high level of shock and vibrations. Careful considerations of possible thermal stresses ensure the absence of hot spots providing long life in environments where temperature cycles are a reality. The thermal design allows operation at full load up to an ambient temperature of 71 °C in free air without using any potting material.

Option:- K-pinout, an alternative to the standard industrial pinout, provides a high level of application specific engineering and design-in flexibility.

Table of Contents

	Page	Page	
Description	1	Thermal considerations..... 6	
Model Selection	2	Mechanical Data	7
Part Number Description	2	Electromagnetic Compatibility (EMC)	7
Functional Description	3	Immunity to Environmental Conditions	8
Electrical Input Data	4	Safety and Installation Instructions	9
Electrical Output Data	5	Description of Options	10

Model Selection

Table 1: Model Selection

Output 1		Output 2		Output Power	Input voltage range	Efficiency	Type designation	Options ²
$U_{o1\ nom}$ [VDC]	$I_{o1\ nom}$ [A] ¹	$U_{o2\ nom}$ [VDC]	$I_{o2\ nom}$ [A] ¹	$P_{o\ nom}$ [W]	[VDC]	η_{typ} [%]		
5	1000	-	-	5.0	18...36	82	24IMS6-05-9	
5	1000	-	-	5.0	36...75	82	48IMS6-05-9	Z
12	500	-	-	6.0	18...36	83	24IMS6-12-9	
12	500	-	-	6.0	36...75	83	48IMS6-12-9	
15	400	-	-	6.0	18...36	84	24IMS6-15-9	
15	400	-	-	6.0	36...75	84	48IMS6-15-9	
+5	500	-5	500	5.0	18...36	82	24IMS6-0505-9	
+5	500	-5	500	5.0	36...75	82	48IMS6-0505-9	
+12	250	-12	250	6.0	18...36	83	24IMS6-1212-9	
+12	250	-12	250	6.0	36...75	83	48IMS6-1212-9	Z
+15	200	-15	200	6.0	18...36	84	24IMS6-1515-9	
+15	200	-15	200	6.0	36...75	84	48IMS6-1515-9	

¹ Flexible load distribution on double outputs possible.

² Not all -K/-Z options exist, to check if option exists and/or for minimum quantity and lead time contact Power-One.

Part Number Description

24 IMS 6 - 12 12 -9 K Z

Input voltage range V_i

18 to 36 VDC 24
36 to 75 VDC 48

Series IMS6

Output voltage type for output 1 05, 12, 15

Output voltage type for output 2 05, 12, 15

Operating ambient temperature range T_A
-40 to 71 °C -9

Options: Alternative pinout (check availability) K
Open frame Z

Examples: 48IMS6-1212-9Z: DC-DC converter, input voltage range 36 to 75V, 2 outputs providing ±12 V, 250 mA, temperature range -40 to 71 °C, no case.

Functional Description

The IMS6 DC-DC converters are feedback controlled flyback converters using current mode PWM (Pulse Width Modulation).

The converter input is protected against transients by means of a suppressor diode.

The output voltage is monitored by a separate transformer winding close to the secondary windings and fed back to the control circuit.

Current limitation is provided by the primary circuit, thus limiting the total output current ($I_{o\ nom}$ for the single and $I_{o1\ nom} + I_{o2\ nom}$ for the dual output types).

The close magnetic coupling provided by the planar construction ensures very good regulation and allows for flexible load distribution on dual output types.

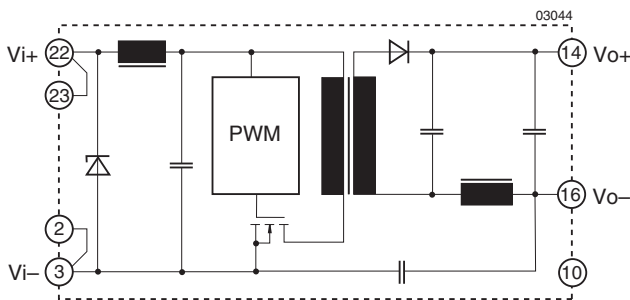

Fig. 1
Block diagram for single output types.
Standard industrial pinout.

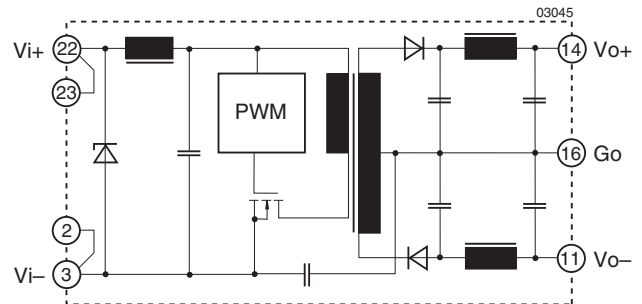

Fig. 2
Block diagram for dual output types.
Standard industrial pinout.

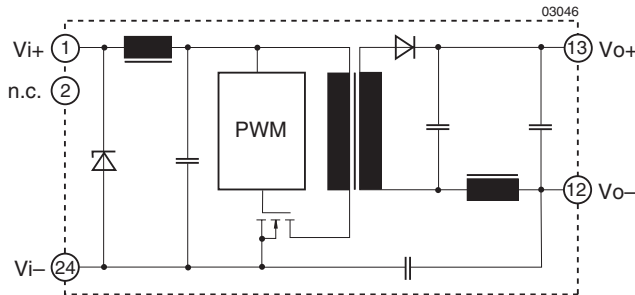

Fig. 3
Block diagram for single output types.
Special pinout (option K).

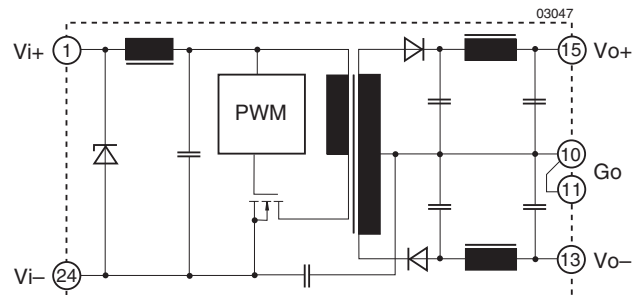

Fig. 4
Block diagram for dual output types.
Special pinout (option K).

Electrical Input Data

General conditions: $T_A = 25\text{ }^\circ\text{C}$, unless T_C is specified.

Table 2: Input Data

Input			24IMS6			48IMS6			
Characteristics	Conditions	min	typ	max	min	typ	max	Unit	
V_i	Input voltage range	$T_C \text{ min to } T_C \text{ max}$		18		36		V DC	
$V_{i \text{ nom}}$	Nominal input voltage	$I_o = 0 \text{ to } I_o \text{ nom}$		24			48		
$V_{i \text{ sur}}$	Repetitive surge voltage	abs. max input (3 s)		40			100		
$t_{\text{start up}}$	Converter start-up time ¹	Worst case condition at $V_{i \text{ min}}$ and full load		0.25	0.5	0.25	0.5	s	
t_{rise}	Rise time ¹	$V_{i \text{ nom}}$ resistive load		5			5	ms	
		$I_o \text{ nom}$ capacitive load		12			12		
$I_{i \text{ o}}$	No load input current	$I_o = 0, V_{i \text{ min to } V_{i \text{ max}}}$		15	20	5	10	mA	
C_i	Input capacitance	for surge calculation		0.54			0.3	μF	
$I_{\text{inr p}}$	Inrush peak current	$V_i = V_{i \text{ nom}}^3$		3.7			4.2	A	
f_s	Switching frequency	$V_{i \text{ min}} \dots V_{i \text{ max}}, I_o = 0 \dots I_o \text{ nom}$		approx. 400			approx. 400	kHz	
$I_{i \text{ rr}}$	Reflected ripple current	$I_o = 0 \text{ to } I_o \text{ nom}$		30			30	mA_{pp}	
$V_{i \text{ RFI}}$	Input RFI level conducted and radiated	EN 55022 ²		B			B		

¹ Measured with a resistive or max. admissible capacitive load. (See fig.: Converter start-up and rise time)

² External filter required. (See: Filter recommendations for compliance with EN standards)

³ Source impedance according to prETS 300132-2, version 4.3.

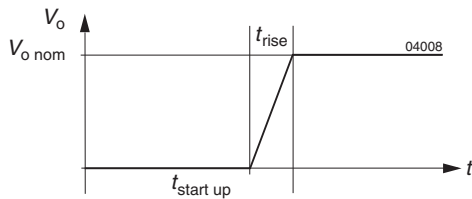

Fig. 5
Converter start-up and rise time

Reverse Polarity Protection at Input

The suppressor diode on the input also provides for reverse polarity protection by conducting current in the reverse direction, thus protecting the unit. An external fuse is required to limit this current:

- For 24IMS6 a fast 1 A (F1A) fuse is recommended
- For 48IMS6 a fast 0.63 A (F0.63A) fuse is recommended

Inrush Current

The inrush current has been kept as low as possible by choosing a very small input capacitance. A series resistor may be inserted in the input line to limit this current further.

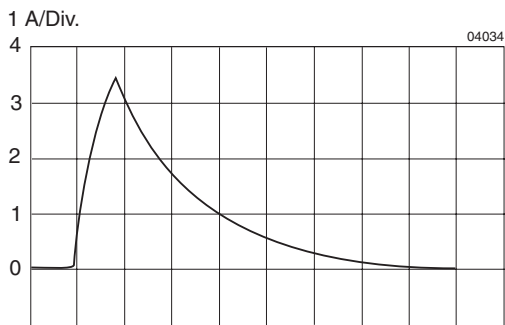

MCD10106 Rev. 1.0, 27-FEB-09 5 $\mu\text{s/Div}$. Page 1 of 10

Fig. 6
Typical inrush current at $U_{i \text{ nom}}, P_{o \text{ nom}}$ versus time measured according to prETS 300132-2, version 4.3.

Filter recommendations for compliance with EN 55022

Electromagnetic emission requirements according to table Input data can be achieved by adding an external capacitor as close as possible to the input terminals.

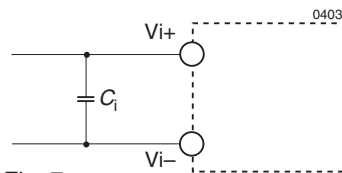

Fig. 7
Input filter arrangement

Table 3: Input filter components (EN 55022)

Ref.	24IMS6	48IMS6
C_i	4.7 μF , 63 V, 85 $^\circ\text{C}$	2.2 μF , 100 V, 85 $^\circ\text{C}$
Type	ceramic or film	

Electrical Output Data

General conditions: $T_A = 25^\circ\text{C}$, unless T_C is specified.

Table 4a: Output data for single output units

Output		$V_{o\text{nom}}$	5 V			12 V			15 V			Unit	
Characteristics		Conditions	min	typ	max	min	typ	max	min	typ	max		
V_o	Output voltage	$V_{i\text{nom}}, I_o = 0.5 I_{o\text{nom}}$	4.96		5.04	11.90		12.10	14.88		15.12	VDC	
$I_{o\text{nom}}$	Output current	$V_{i\text{min}}$ to $V_{i\text{max}}$	1000			500			400			mA	
I_{oL}	Current limit ²	$V_{i\text{nom}}, T_C = 25^\circ\text{C}$	1400			700			600				
ΔV_{oU}	Line regulation	$V_{i\text{min}} \dots V_{i\text{max}}, I_{o\text{nom}}$	± 1			± 1			± 1			%	
ΔV	Load regulation	$V_{i\text{nom}}$ $I_o = (0.1 \dots 1) I_{o\text{nom}}$	± 3			± 3			± 3				
$V_{o1,2}$	Output voltage noise	$V_{i\text{min}}$ to $V_{i\text{max}}$ $I_o = I_{o\text{nom}}$	80			120			150			mV _{pp}	
			20	40		40	60		50	75			
$V_{o\text{clip}}$	Output overvoltage limitation	Min. load 1%	130			130			130			%	
$C_{o\text{ext}}$	Admissible capacitive load ³		680			150			100			μF	
V_{od}	Dynamic load regulat.	Voltage deviat. Recovery time	$V_{i\text{nom}}$ $I_{o\text{nom}} \times 1/2 I_{o\text{nom}}$	± 250			± 250			± 250			mV
t_d				1			1			1			ms
α_{V_o}	Temperature coefficient $\Delta V_o / \Delta T_C$	$V_{i\text{min}}$ to $V_{i\text{max}}$ $I_o = 0$ to $I_{o\text{nom}}$	± 0.02			± 0.02			± 0.02			%/K	

Table 4b: Output data for dual output units

Output		$V_{o\text{nom}}$	$\pm 5 \text{ V}$			$\pm 12 \text{ V}$			$\pm 15 \text{ V}$			Unit	
Characteristics		Conditions	min	typ	max	min	typ	max	min	typ	max		
V_{o1} V_{o2}	Output voltage	$V_{i\text{nom}}$ $I_{o1} = I_{o2} = 0.5 I_{o\text{nom}}$	4.96		5.04	11.90		12.10	14.88		15.12	VDC	
			4.95		5.05	11.88		12.12	14.85		15.15		
$I_{o\text{nom}}$	Output current ¹	$V_{i\text{min}} \dots V_{i\text{max}}$	2 x 500			2 x 250			2 x 200			mA	
P_{oL}	Power limit ^{2,3}	$V_{i\text{nom}}, T_C = 25^\circ\text{C}$	2 x 3.5			2 x 4.0			2 x 4.2				
ΔV_{oU}	Line regulation	$V_{i\text{min}} \dots V_{i\text{max}}, I_{o\text{nom}}$	± 1			± 1			± 1			%	
ΔV	Load regulation ⁴	$V_{i\text{nom}}$ $I_o = (0.1 \dots 1) I_{o\text{nom}}$	± 3			± 3.5			± 3				
$V_{o1,2}$	Output voltage noise	$V_{i\text{min}} \dots V_{i\text{max}}$ ⁵ $I_o = I_{o\text{nom}}$ ⁶	100			140			150			mV _{pp}	
			40	60		45	70		50	75			
$V_{o\text{clip}}$	Output overvoltage limitation	Min. load 1%	130			130			130			%	
$C_{o\text{ext}}$	Admissible capacitive load ³		680			150			100			μF	
V_{od}	Dynamic load regulat.	Voltage deviat. Recovery time	$V_{i\text{nom}}$ $I_{o\text{nom}} \times 1/2 I_{o\text{nom}}$	± 250			± 600			± 750			mV
t_d				1			1			1			ms
α_{V_o}	Temperature coefficient $\Delta U_o / \Delta T_C$	$V_{i\text{min}}$ to $V_{i\text{max}}$ $I_o = 0$ to $I_{o\text{nom}}$	± 0.02			± 0.02			± 0.02			%/K	

¹ Each output capable of delivering full output power.

² The current limit is primary side controlled.

³ Sum of both outputs.

⁴ Conditions for specified output. Other output loaded with constant current $I_o = 0.5 I_{o\text{nom}}$.

⁵ BW = 20 MHz.

⁶ Measured with a probe according to EN 61204.

Thermal Considerations

If a converter, mounted on a PCB, is located in free, quasi-stationary air (convection cooling) at the indicated maximum ambient temperature $T_{A \max}$ (see table: *Temperature specifications*) and is operated at its nominal input voltage and output power, the case temperature T_C measured at the: *Measuring point of case temperature T_C* (see: *Mechanical Data*) will approach the indicated value $T_{C \max}$ after the warm-up phase. However, the relationship between T_A and T_C depends heavily on the conditions of operation and integration into a system. The thermal conditions are influenced by input voltage, output current, airflow, temperature of surrounding components and surfaces and the properties of the printed circuit board. $T_{A \max}$ is therefore only an indicative value and under practical operating conditions, the ambient temperature T_A may be higher or lower than this value.

Caution: The case temperature T_C measured at the *Measuring point of case temperature T_C* (see: *Mechanical Data*) may under no circumstances exceed the specified maximum value. The installer must ensure that under all operating conditions T_C remains within the limits stated in the table: *Temperature specifications*.

Typical Performance Curves

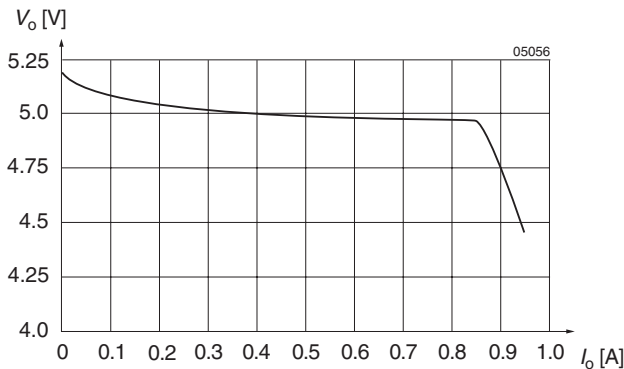

Fig. 8
 U_o versus I_o (typ) of single output units
(example for 48IMS6-05-9)

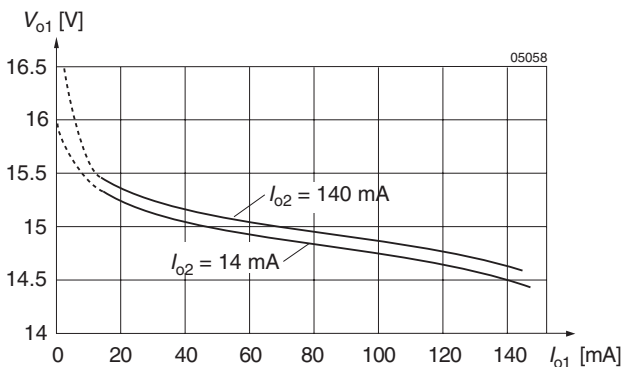

Fig. 10
Cross load regulation of dual output units. U_{o1} versus I_{o1} (typ) for various I_{o2} (48IMS6-1515-9).

Output overvoltage protection

The outputs of the IMS6 converters are protected against overvoltages by Zener diodes. In the event of an overvoltage on the output, the unit will shut down and attempt to restart automatically. The main purpose of this feature is to protect against possible overvoltages which could occur due to a failure in the feedback control circuit. The converters are not designed to withstand external overvoltages applied to the outputs.

Connection in series

The outputs of single or dual output units can be connected in series without any precautions, taking into consideration that the highest output voltage should remain below 60 V for SELV operation.

Connection in parallel

The outputs of several units with equal nominal output voltage can be connected in parallel. Approximate current sharing between 2 or several units is ensured by their load dependent output characteristic.

Short Circuit Behavior

The current limit characteristic shuts down the converter whenever a short circuit is applied to its output. It acts self-protecting and automatically recovers after removal of the overload condition.

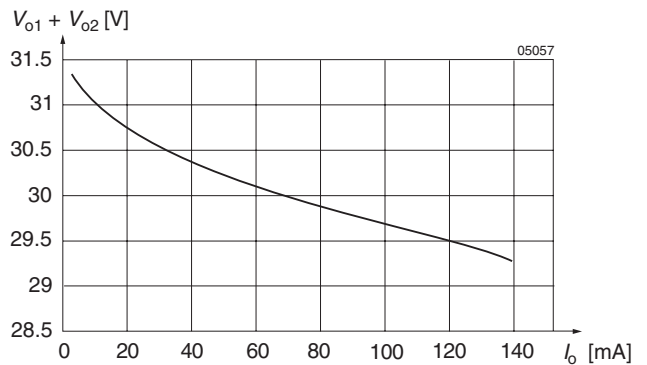

Fig. 9
 U_o versus I_o (typ) of dual output units (± 15 V), with 30 V load connected to V_{o+} and V_{o-} .

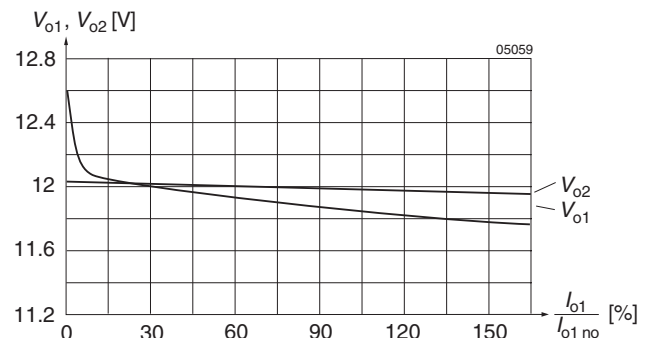

Fig. 11
Flexible load distribution on dual outputs (2×12 V) with load variation from 0 to 150% of $P_{o1 \text{ nom}}$ on output 1. Output 2 loaded with 25% of $P_{o2 \text{ nom}}$.

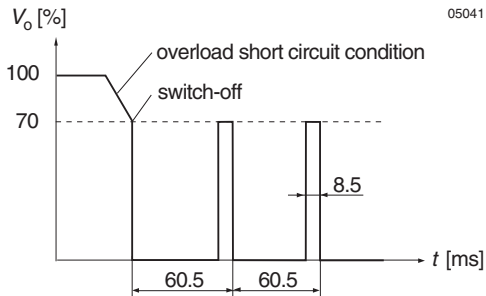

Fig. 12
Overload switch-off (hiccup mode).
Frequency of pulses: 16.5 Hz, puls duration: 8.5 ms.

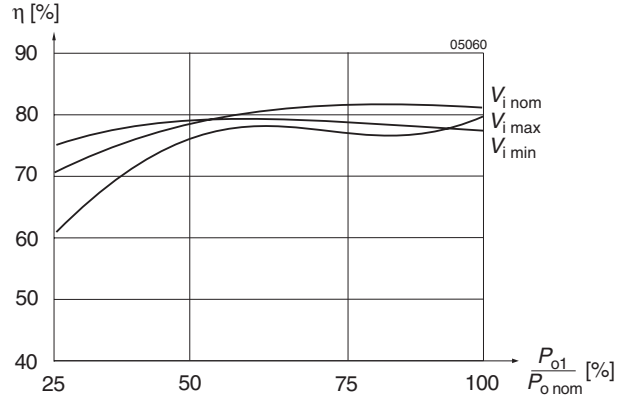

Fig. 13
Efficiency versus input voltage and load.
Typical values (48 IMS 6-1212-9).

Electromagnetic Emission

Conducted RFI noise at input according to EN 55022

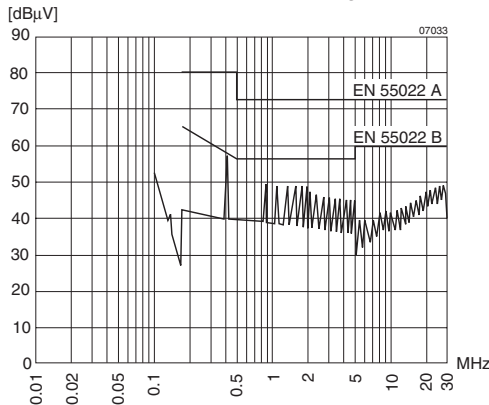

Fig. 14
Typical disturbance voltage (quasi-peak) at the input according to CISPR 11/EN 55011 and CISPR 22/EN 55022, measured at $U_{i nom}$ and $I_{o nom}$. Output leads 0.1 m, twisted. External capacitor at the input required (see: Recommendations for compliance with EN 55022) (48IMS6-1515-9).

Radiated RFI noise according to EN 55022.

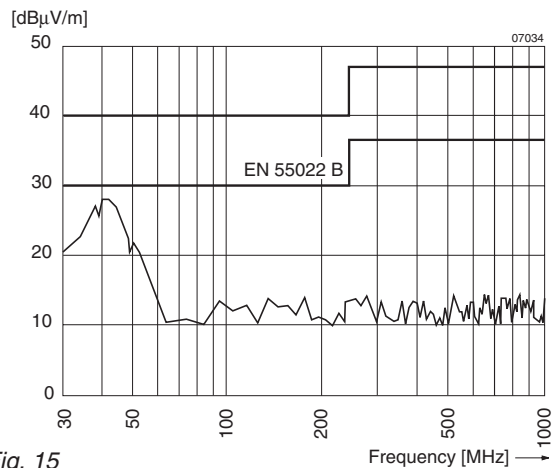

Fig. 15
Typical radio frequency interference voltage at $U_{i nom}$, $I_{o nom}$, measured with an antenna (distance 10 m). Output leads 0.1 m, twisted (48IMS6-1515-9).

Mechanical Data

Dimensions in mm. Tolerances ± 0.3 mm unless otherwise indicated.

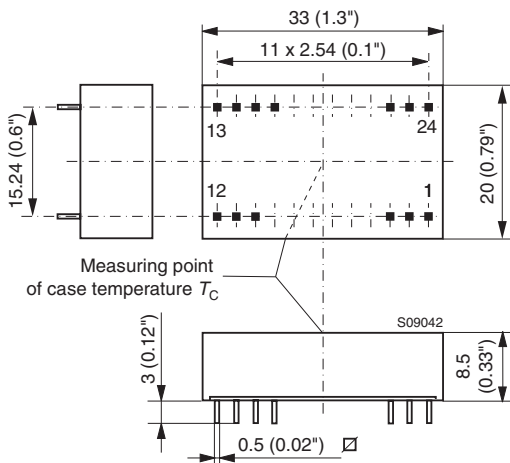

Fig. 16
Standard or alternative pinout
Weight: <10 g

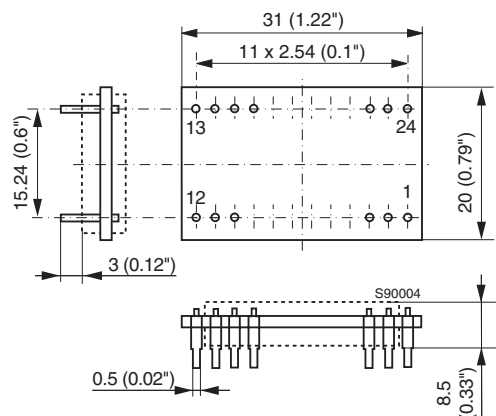

Fig. 17
Open frame (Option Z)
Weight: <10 g

Immunity to Environmental Conditions

Table 5: Environmental testing

Test Method		Standard	Test Conditions		Status
Ca	Damp heat steady state	IEC/DIN IEC 60068-2-3 MIL-STD-810D section 507.2	Temperature: Relative humidity: Duration:	40 ^{±2} °C 93 ^{+2/-3} % 56 days	Unit not operating
Ea	Shock (half-sinusoidal)	IEC/EN/DIN EN 60068-2-27 MIL-STD-810D section 516.3	Acceleration amplitude: Bump duration: Number of bumps:	100 g _n = 981 m/s ² 6 ms 18 (3 each direction)	Unit operating
Eb	Bump (half-sinusoidal)	IEC/EN/DIN EN 60068-2-29 MIL-STD-810D section 516.3	Acceleration amplitude: Bump duration: Number of bumps:	40 g _n = 392 m/s ² 6 ms 6000 (1000 each direction)	Unit operating
Fc	Vibration (sinusoidal)	IEC/EN/DIN EN 60068-2-6	Acceleration amplitude: Frequency (1 Oct/min): Test duration:	0.35 mm (10 to 60 Hz) 5 g _n = 49 m/s ² (60...2000 Hz) 10 to 2000 Hz 7.5 h (2.5 h each axis)	Unit operating
Fh	Vibration, broad-band random (digital control)	IEC/EN 60068-2-64 DIN 40046 part 23 MIL-STD-810D section 514.3	Acceleration spectral density: Frequency band: Acceleration magnitude: Test duration:	0.05 g _n ² /Hz 10...500 Hz 4.9 g _{n rms} 3 h (1 h each axis)	Unit operating
Kb	Salt mist, cyclic (sodium chloride NaCl solution)	IEC/EN/DIN IEC 60068-2-52	Concentration: Duration: Storage: Storage duration: Number of cycles:	5% (30 °C) 2 h per cycle 40°C, 93% rel. humidity 22 h per cycle 3	Unit not operating

Table 6: Temperature specifications, valid for air pressure of 800 to 1200 hPa (800 to 1200 mbar)

Temperature		Standard -9		Unit
Characteristics	Conditions	min	max	
T _A Ambient temperature ¹	Operational ²	-40	71	°C
T _C Case temperature		-40	95	
T _S Storage temperature ¹	Non operational	-40	100	

¹ MIL-STD-810D section 501.2 and 502.2

² See *Thermal Considerations*

Table 7: MTBF and device hours

MTBF	Ground Benign	Ground Fixed		Ground Mobile
MTBF acc. to MIL-HDBK-217F	T _C = 40 °C	T _C = 40 °C	T _C = 70 °C	T _C = 50 °C
48IMS6-05-9	2'651'000 h	349'000 h	124'000 h	119'000 h

Safety and Installation Instructions

Installation Instruction

Installation of the DC-DC converters must strictly follow the national safety regulations in compliance with the enclosure, mounting, creepage, clearance, casualty, markings and segregation requirements of the end-use application.

Connection to the system shall be made via a printed circuit board according to: *Mechanical Data*.

The units should be connected to a secondary circuit.

Check for hazardous voltages before altering any connections.

Do not open the module.

Ensure that a unit failure (e.g. by an internal short-circuit) does not result in a hazardous condition. See also: *Safety of operator accessible output circuit*.

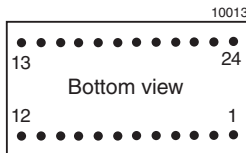

Fig. 18
Pin numbering

Input Fuse

To prevent excessive current flowing through the input supply line in case of a short-circuit across the converter input an external fuse should be installed in a non-earthed input supply line. We recommend a fast acting fuse F1A for 24IMS6 and F0.5A for 48IMS6 models.

Safety of operator accessible output circuits

If the output circuit of a DC-DC converter is operator accessible, it shall be an SELV circuit according to IEC/EN 60950 related safety standards

The insulation concept table below shows some possible installation configurations, compliance with which causes the output circuit of the DC-DC converter to be an SELV circuit according to IEC/EN 60950 up to a configured output voltage (sum of nominal voltages if in series or +/- configuration) of 46 V.

However, it is the sole responsibility of the installer to ensure the compliance with the relevant and applicable safety regulations. More information is given in: *Technical Information: Safety*.

NUCLEAR AND MEDICAL APPLICATIONS - Power-One products are not designed, intended for use in, or authorized for use as critical components in life support systems, equipment used in hazardous environments, or nuclear control systems without the express written consent of the respective divisional president of Power-One, Inc.

TECHNICAL REVISIONS - The appearance of products, including safety agency certifications pictured on labels, may change depending on the date manufactured. Specifications are subject to change without notice.

Table 8: Pin allocation for standard industrial pinout

Pin	Single output units	Dual output units
2	Vi-	Vi-
3	Vi-	Vi-
10	n.c.	-
11	-	Vo-
14	Vo+	Vo+
16	Vo-	Go
22	Vi+	Vi+
23	Vi+	Vi+

Table 9: Pin allocation for K pinout (option K)

Pin	Single output units	Dual output units
1	Vi+	Vi+
2	n.c.	-
10	-	Go
11	-	Go
12	Vo-	-
13	Vo+	Vo-
15	-	Vo+
24	Vi-	Vi-

Standards and approvals

All DC-DC converters are UL recognized according to UL 1950, UL recognized for Canada to CAN/CSA C22.2 No. 950-95 and LGA approved to IEC/EN 60950 standards.

The units have been evaluated for:

- Building in
- Basic insulation input to output, based on their maximum input voltage
- The use in a pollution degree 2 environment
- Connecting the input to a secondary circuit which is subject to a maximum transient rating of 1500 V for IMS 6.

The DC-DC converters are subject to manufacturing surveillance in accordance with the above mentioned UL, CSA, EN and ISO 9001 standards.

Cleaning Agents

In order to avoid possible damage, any penetration of cleaning fluids has to be prevented, since the power supplies are not hermetically sealed.

Protection Degree

The protection degree of the DC-DC converters is IP 30.

Isolation

The electric strength test is performed as factory test in accordance with IEC/EN 60950 and UL 1950 and should not be repeated in the field. Power-One will not honor any warranty claims resulting from electric strength field tests.

Table 10: Electric strength test voltages

Characteristic	Input - Output IMS6	Unit
Electric strength test voltage 1 s	1.2	kV _{rms}
	1.5	kV DC
Coupling capacitance	1.2	nF
Insulation resist. at 500 V DC	>100	MΩ
Partial discharge extinction voltage	Consult factory	kV

Table 11: Insulation concept leading to an SELV output circuit

Conditions	Front end			DC-DC converter	Result
Supply voltage	Minimum required grade of isolation, to be provided by the AC-DC front end, including mains supplied battery charger	Maximum DC output voltage from the front end ¹	Minimum required safety status of the front end output circuit	Measures to achieve the specified safety status of the output circuit	Safety status of the DC-DC converter output circuit
Mains <250 V AC	Basic	<60 V	Earthed SELV circuit ²	Operational insulation, provided by the DC-DC converter	SELV circuit
			ELV circuit	Input fuse ³ output suppressor diodes ⁴ , and earthed output circuit ²	Earthed SELV circuit
	Double or reinforced	<60 V	SELV circuit	Operational insulation, provided by the DC-DC converter	SELV circuit
			TNV-2 circuit	Basic insulation, based on the maximum input voltage, provided by the DC-DC converter	
		>60 V	Hazardous voltage secondary circuit		
		>60 V	Double or reinforced insulated unearthed hazardous voltage secondary circuit ⁵		

- ¹ The front end output voltage should match the specified input voltage range of the DC-DC converter.
- ² The earth connection has to be provided by the installer according to the relevant safety standard, e.g. IEC/EN 60950.
- ³ The installer shall provide an approved fuse (type with the lowest rating suitable for the application) in a non-earthed input line directly at the input of the DC-DC converter (see fig.: *Schematic safety concept*). For UL's purpose, the fuse needs to be UL-listed. See also: *Input Fuse*.
- ⁴ Each suppressor diode should be dimensioned in such a way, that in the case of an insulation fault the diode is able to limit the output voltage to SELV (<60 V) until the input fuse blows (see fig.: *Schematic safety concept*).
- ⁵ Has to be insulated from earth by double or reinforced insulation according to the relevant safety standard, based on the maximum output voltage from the front end.

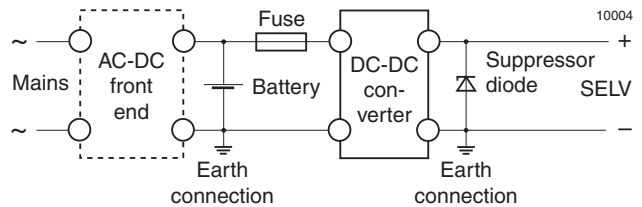

Fig. 19 Schematic safety concept. Use fuse, suppressor diode and earth connection as per table: Safety concept leading to an SELV output circuit.

Description of Options

Table 12: Survey of options

Option	Function of option	Characteristic
K	Alternative pinout	Contact factory for availability
Z	Open frame	All models are available without case