

# HEAVYCON

## Standard Housings Type B

### 1. Short description

HEAVYCON plug connectors are just as common in measurement and control engineering as in mechanical and plant engineering. They are used for both power supply and control. Another sector in which they are often to be found is in lighting and stage systems.

HEAVYCON plug connectors also act as the interface for PCs or diagnostics equipment to transfer operating data or monitoring signals during system operation.

The HEAVYCON housings are divided into:

- **Permanently installed housings**
- Box mounting base with one or two cable entries
- Panel mounting base with an aperture in the floor for control cabinet mounting
- **Free housings**
- Sleeve housing
- Coupling housing

The user can choose between a variety of different housing heights that offer sufficient connection space for large conductor cross sections.

Double width HEAVYCON housings (type B 32 and B 48) allow two contact inserts to be accommodated in one housing.



### Type description

	HC	-	B	10	-	T	FL	-	45	/	M	1	ST	PG16	G
<b>HEAVYCON</b>															
Type	B														
No. of positions	10														
T	= Sleeve housing														
A	= Panel mounting base														
S	= Box mounting base														
K	= Coupling housing														
FL	= For single locking latch,														
FQ	= For double locking latch,														
ML	= with single locking latch,														
MQ	= with double locking latch,														
D	= with cover														
Housing height h in mm	45														
M	= with gland														
O	= without gland or supports														
Number of glands or screw connections	1														
ST	= supports														
PG	= Pg cable gland,														
M	= Metric gland														
G	= straight,														
S	= lateral														

**Type B 6,  
Sleeve housings,  
with Pg screw connection**



Description	Height h [mm]	Screw connection	Cable exit	Type	Order No.	Pcs./Pkt.
<b>Sleeve housing</b> , for single locking latch	40	Pg 13,5	straight	HC-B 6-TFL-40/M1PG13,5G	17 71 12 1	10
	43	Pg 13,5	lateral	HC-B 6-TFL-43/M1PG13,5S	17 71 11 8	
	43	Pg 13,5	lateral	HC-B 6-TFL-43/M2PG13,5S	16 79 05 8	
	72	Pg 21	lateral	HC-B 6-TFL-72/M1PG21S	16 79 63 4	
<b>Technical data</b>						
<b>Degree of protection</b>	IP65					
<b>Material</b>	die-cast aluminum, powder-coated, gray					
<b>Housing</b>						
<b>Ambient temperature</b>	[°C] - 40 to +125					

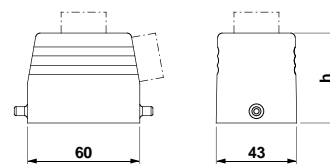

HC-B 6 TFL...

**Type B 6,  
Sleeve housings,  
for metric screw connections**



Description	Height h [mm]	Screw connection	Cable exit	Type	Order No.	Pcs./Pkt.
<b>Sleeve housing, for single locking latch</b>	40	M 20	straight	HC-B 6-TFL-40/O1M20G	16 04 73 1	10
	43	M 20	lateral	HC-B 6-TFL-43/O1M20S	16 04 73 2	
	43	M 25	lateral	HC-B 6-TFL-43/O1M25S	16 04 73 3	
	72	M 20	lateral	HC-B 6-TFL-72/O1M20S	16 04 73 4	
	72	M 25	straight	HC-B 6-TFL-72/O1M25G	16 04 73 5	
	72	M 25	lateral	HC-B 6-TFL-72/O1M25S	16 04 73 6	
	72	M 32	lateral	HC-B 6-TFL-72/O1M32S	16 04 73 7	

**Technical data**

**Degree of protection**

IP65

**Material**

die-cast aluminum, powder-coated, gray

**Housing**

**Ambient temperature**

[°C]

- 40 to +125

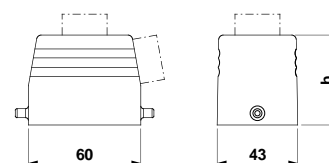

HC-B 6 TFL...

**Type B 6,  
Sleeve housings,  
for metric screw connections,  
without support**



Description	Height h [mm]	Screw connection	Cable exit	Type	Order No.	Pcs./Pkt.
<b>Sleeve housing</b> , for single locking latch, <b>without support</b>	72	M 20	straight	HC-B 6-TFL-72/O1STM20G	<b>16 45 29 9</b>	10
	72	M 20	lateral	HC-B 6-TFL-72/O1STM20S	<b>16 44 92 8</b>	
	72	M 25	straight	HC-B 6-TFL-72/O1STM25G	<b>16 44 93 1</b>	
	72	M 25	lateral	HC-B 6-TFL-72/O1STM25S	<b>16 44 94 4</b>	
	72	M 32	straight	HC-B 6-TFL-72/O1STM32G	<b>16 45 30 9</b>	
	72	M 32	lateral	HC-B 6-TFL-72/O1STM32S	<b>16 44 95 7</b>	

**Technical data**

**Degree of protection**

IP65

**Material**

die-cast aluminum, powder-coated, gray

Housing

**Ambient temperature**

[°C]

- 40 to +125

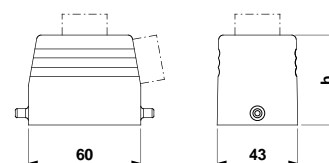

HC-B 6 TFL...

# Type B 6, Panel mounting bases



Description	Height h [mm]	Screw connection	Protective cover	Type	Order No.	Pcs./Pkt.
<b>Panel mounting base, with single locking latch</b>	27	–	no	<b>HC-B 6-AML</b>	<b>17 71 13 4</b>	10
	27	–	yes	<b>HC-B 6-AMLD</b>	<b>17 71 14 7</b>	
<b>Technical data</b>						
<b>Degree of protection</b>					IP65	
<b>Material</b>						
Housing					die-cast aluminum, powder-coated, gray	
Seal					NBR	
Single locking latch					zinc-plated steel and passivated	
<b>Ambient temperature</b>			[°C]		– 40 to +125	

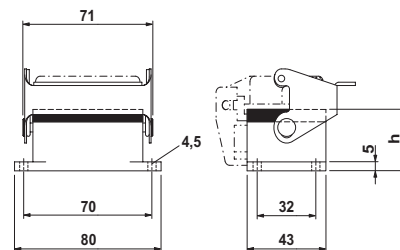

HC-B 6 AML...

# Type B 6, Box mounting bases, with Pg screw connection



Description	Height h [mm]	Screw connection	Protective cover	Type	Order No.	Pcs./Pkt.
<b>Box mounting base, with single locking latch</b>	52	Pg 16	no	HC-B 6-SML-52/M1PG16	17 71 15 0	10
	52	2 x Pg 16	no	HC-B 6-SML-52/M2PG16	17 71 16 3	
	52	Pg 16	yes	HC-B 6-SMLD-52/M1PG16	17 71 17 6	
	52	2 x Pg 16	yes	HC-B 6-SMLD-52/M2PG16	17 71 18 9	
	74	Pg 21	no	HC-B 6-SML-74/O1PG21	16 78 15 6	

## Technical data

**Degree of protection**

IP65

**Material**

die-cast aluminum, powder-coated, gray

Housing

Seal

NBR

Single locking latch

zinc-plated steel and passivated

**Ambient temperature**

[°C]

- 40 to +125

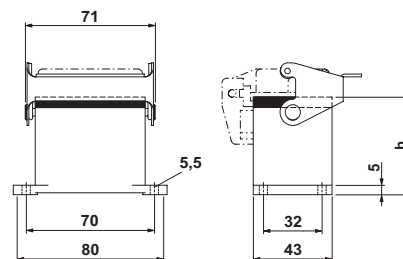

HC-B 6 SML(D)...

## Type B 6, Box mounting bases, for metric screw connections



Description	Height h [mm]	Screw connection	Protective cover	Type	Order No.	Pcs./Pkt.
Box mounting base, with single locking latch	52	M 20	no	HC-B 6-SML-52/O1M20	16 04 72 1	10
	52	M 25	no	HC-B 6-SML-52/O1M25	16 04 72 2	
	52	2 x M 20	no	HC-B 6-SML-52/O2M20	16 04 72 3	
	52	2 x M 25	no	HC-B 6-SML-52/O2M25	16 04 72 4	
	74	M 25	no	HC-B 6-SML-74/O1M25	16 04 72 5	
	52	M 25	yes	HC-B 6-SMLD-52/O1M25	16 04 72 8	
	52	2 x M 20	yes	HC-B 6-SMLD-52/O2M20	16 04 72 9	
	52	2 x M 25	yes	HC-B 6-SMLD-52/O2M25	16 04 73 0	

### Technical data

Degree of protection

IP65

Material

die-cast aluminum, powder-coated, gray

Housing

Seal

NBR

Single locking latch

zinc-plated steel and passivated

Ambient temperature

[°C]

- 40 to +125

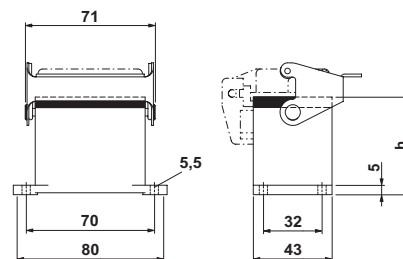

HC-B 6 SML(D)...

# Type B 6, Coupling housings, with Pg srew connection



Description	Height h [mm]	Screw connection	Type	Order No.	Pcs./Pkt.
Coupling housing, with single locking latch	52	Pg 13,5	HC-B 6-KML-52/M1PG13,5	17 71 19 2	10
<b>Technical data</b>					
<b>Degree of protection</b>	IP65				
<b>Material</b>	die-cast aluminum, powder-coated, gray				
Housing	NBR				
Seal	zinc-plated steel and passivated				
Single locking latch	- 40 to +125				
<b>Ambient temperature</b>	[°C]				

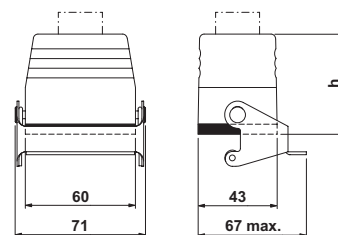

HC-B 6 KML...



# Type B 6, Coupling housings, for metric screw connections



Description	Height h [mm]	Screw connection	Type	Order No.	Pcs./Pkt.
Coupling housing, with single locking latch	52	M 20	HC-B 6-KML-52/O1M20	16 04 71 9	10
<b>Technical data</b>					
Degree of protection	IP65				
Material	die-cast aluminum, powder-coated, gray				
Housing	NBR				
Seal	zinc-plated steel and passivated				
Single locking latch	- 40 to +125				
Ambient temperature	[°C]				

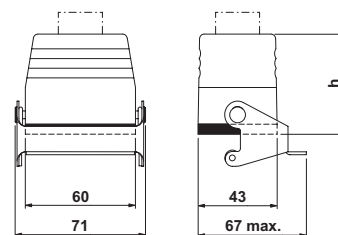

HC-B 6 KML...

# Type B 10, Sleeve housings, with Pg screw connection



Description	Height h [mm]	Screw connection	Cable exit	Type	Order No.	Pcs./Pkt.
<b>Sleeve housing</b> , for single locking latch	45	Pg 16	straight	HC-B 10-TFL-45/M1PG16G	17 71 31 2	10
	52	Pg 16	lateral	HC-B 10-TFL-52/M1PG16S	17 71 30 9	
<b>Sleeve housing</b> , for double locking latch	45	Pg 16	straight	HC-B 10-TFQ-45/M1PG16G	17 71 25 7	10
	52	Pg 16	lateral	HC-B 10-TFQ-52/M1PG16S	17 71 24 4	
<b>Sleeve housing</b> , with double locking latch	45	Pg 16	straight	HC-B 10-TMQ-45/M1PG16G	17 71 28 6	10
	52	Pg 16	lateral	HC-B 10-TMQ-52/M1PG16S	17 71 27 3	

### Technical data

**Degree of protection**

IP65

**Material**

die-cast aluminum, powder-coated, gray

Housing

high-grade steel, handle: PA-GF

Double locking latch

**Ambient temperature**

[°C]

- 40 to +125

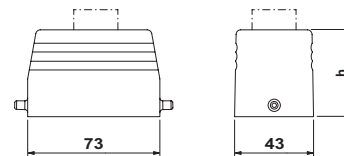

HC-B 10 TFL...

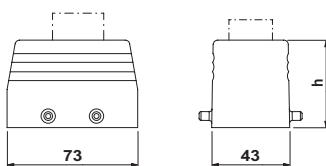

HC-B 10 TFQ...

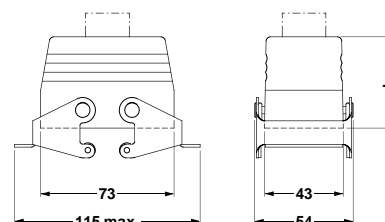

HC-B 10 TMQ...

# Type B 10, Sleeve housings, for metric screw connections



Description	Height h [mm]	Screw connection	Cable exit	Type	Order No.	Pcs./Pkt.
<b>Sleeve housing, for single locking latch</b>	45	M 20	straight	HC-B 10-TFL-45/O1M20G	16 04 75 8	10
	45	M 25	straight	HC-B 10-TFL-45/O1M25G	16 04 75 9	
	52	M 20	lateral	HC-B 10-TFL-52/O1M20S	16 04 76 0	
	52	M 25	lateral	HC-B 10-TFL-52/O1M25S	16 04 76 1	
	72	M 25	straight	HC-B 10-TFL-72/O1M25G	16 04 76 2	
	72	M 25	lateral	HC-B 10-TFL-72/O1M25S	16 04 76 3	
	72	M 32	straight	HC-B 10-TFL-72/O1M32G	16 04 76 4	
<b>Sleeve housing, for double locking latch</b>	45	M 20	straight	HC-B 10-TFQ-45/O1M20G	16 04 76 9	10
	45	M 25	straight	HC-B 10-TFQ-45/O1M25G	16 04 77 0	
	52	M 20	lateral	HC-B 10-TFQ-52/O1M20S	16 04 77 1	
	52	M 25	lateral	HC-B 10-TFQ-52/O1M25S	16 04 77 2	
	72	M 25	straight	HC-B 10-TFQ-72/O1M25G	16 04 77 3	
	72	M 25	lateral	HC-B 10-TFQ-72/O1M25S	16 04 77 4	
	72	M 32	straight	HC-B 10-TFQ-72/O1M32G	16 04 77 5	
<b>Sleeve housing, with double locking latch</b>	52	M 20	lateral	HC-B 10-TMQ-52/O1M20S	16 04 78 0	10
	52	M 25	lateral	HC-B 10-TMQ-52/O1M25S	16 04 78 1	

## Technical data

**Degree of protection**  
**Material**  
Housing  
Double locking latch  
**Ambient temperature**

[°C]

IP65

die-cast aluminum, powder-coated, gray  
high-grade steel, handle: PA-GF  
- 40 to +125

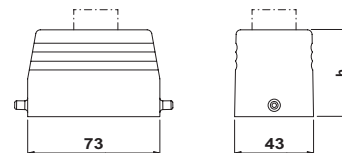

HC-B 10 TFL...

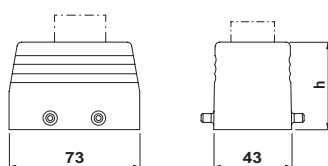

HC-B 10 TFQ...

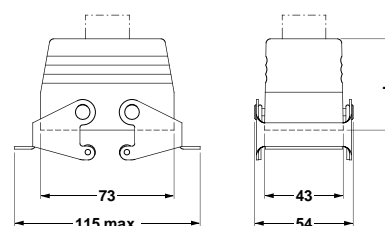

HC-B 10 TMQ...

**Type B 10,  
Sleeve housings,  
for metric screw connections,  
without support**



Description	Height h [mm]	Screw connection	Cable exit	Type	Order No.	Pcs./Pkt.
<b>Sleeve housing</b> , for single locking latch	72	M 25	straight	HC-B 10-TFL-72/O1STM25G	16 44 96 0	10
	72	M 25	lateral	HC-B 10-TFL-72/O1STM25S	16 44 97 3	
	72	M 32	straight	HC-B 10-TFL-72/O1STM32G	16 44 98 6	
	72	M 32	lateral	HC-B 10-TFL-72/O1STM32S	16 45 31 2	
<b>Sleeve housing</b> , for double locking latch	72	M 25	straight	HC-B 10-TFQ-72/O1STM25G	16 44 99 9	10
	72	M 25	lateral	HC-B 10-TFQ-72/O1STM25S	16 45 00 8	
	72	M 32	straight	HC-B 10-TFQ-72/O1STM32G	16 45 01 1	
	72	M 32	lateral	HC-B 10-TFQ-72/O1STM32S	16 45 32 5	

**Technical data**

**Degree of protection**

IP65

**Material**

Housing

die-cast aluminum, powder-coated, gray

**Ambient temperature**

[°C]

- 40 to +125

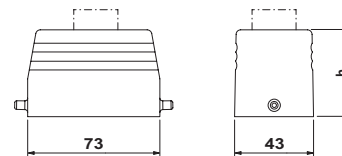

HC-B 10 TFL...

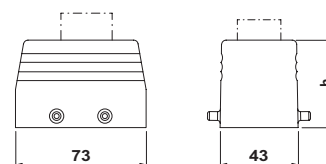

HC-B 10 TFQ...

# Type B 10, Panel mounting bases



Description	Height h [mm]	Screw connection	Protective cover	Type	Order No.	Pcs./Pkt.
Panel mounting base, with single locking latch	27	–	no	HC-B 10-AML	17 71 33 8	10
	27	–	yes	HC-B 10-AMLD	17 71 35 4	10
Panel mounting base, with double locking latch	27	–	no	HC-B 10-AMQ	17 71 32 5	10
Panel mounting base, for double locking latch	27	–	yes	HC-B 10-AFQD	17 71 34 1	10

### Technical data

Degree of protection

IP65

Material

Housing

die-cast aluminum, powder-coated, gray

Seal

NBR

Single locking latch

zinc-plated steel and passivated

Double locking latch

high-grade steel, handle: PA-GF

Ambient temperature

[°C]

– 40 to +125

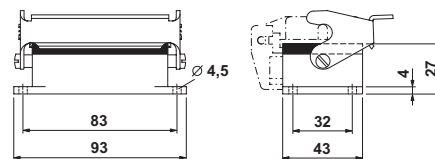

HC-B 10 AML...

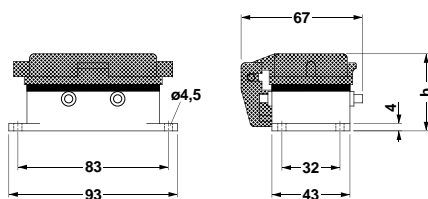

HC-B 10 AFQ...

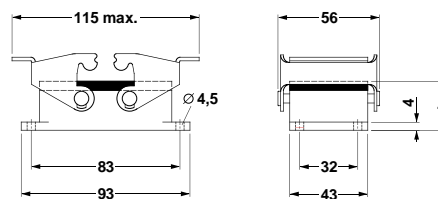

HC-B 10 AMQ...

# Type B 10, Box mounting bases, with Pg screw connection



Description	Height h [mm]	Screw connection	Protective cover	Type	Order No.	Pcs./Pkt.
<b>Box mounting base, with single locking latch</b>	52	Pg 16	no	HC-B 10-SML-52/M1PG16	17 71 38 3	10
	52	2 x Pg 16	no	HC-B 10-SML-52/M2PG16	17 71 39 6	
	52	Pg 16	yes	HC-B 10-SMLD-52/M1PG16	17 71 42 2	
	52	2 x Pg 16	yes	HC-B 10-SMLD-52/M2PG16	17 71 43 5	
<b>Box mounting base, with double locking latch</b>	52	Pg 16	no	HC-B 10-SMQ-52/M1PG16	17 71 36 7	10
	52	2 x Pg 16	no	HC-B 10-SMQ-52/M2PG16	17 71 37 0	
<b>Box mounting base, for double locking latch</b>	52	Pg 16	yes	HC-B 10-SFQD-52/M1PG16	17 71 40 6	10
	52	2 x Pg 16	yes	HC-B 10-SFQD-52/M2PG16	17 71 41 9	

## Technical data

Degree of protection

IP65

Material

die-cast aluminum, powder-coated, gray

Housing

NBR

Seal

zinc-plated steel and passivated

Single locking latch

high-grade steel, handle: PA-GF

Double locking latch

Ambient temperature

[°C]

- 40 to +125

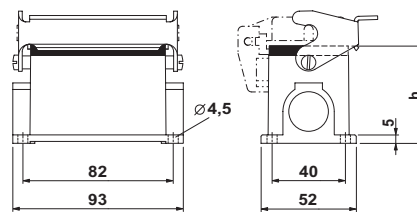

HC-B 10 SML...

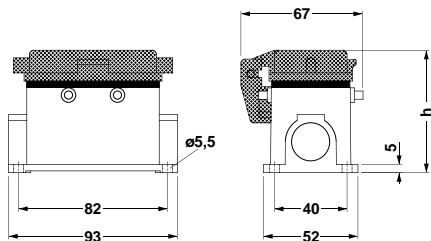

HC-B 10 SFQ...

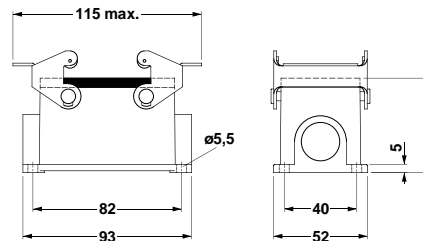

HC-B 10 SMQ...

# Type B 10, Box mounting bases, for metric screw connections



Description	Height h [mm]	Screw connection	Protective cover	Type	Order No.	Pcs./Pkt.
<b>Box mounting base, with single locking latch</b>	52	M 25	no	HC-B 10-SML-52/O1M25	16 04 74 9	10
	52	2 x M 20	yes	HC-B 10-SMLD-52/O2M20	16 04 75 0	
	52	2 x M 25	yes	HC-B 10-SMLD-52/O2M25	16 04 75 1	
<b>Box mounting base, with double locking latch</b>	52	M 20	no	HC-B 10-SMQ-52/O1M20	16 04 75 2	10
	52	2 x M 20	no	HC-B 10-SMQ-52/O2M20	16 04 75 3	
	52	2 x M 25	no	HC-B 10-SMQ-52/O2M25	16 04 75 4	
	74	M 25	no	HC-B 10-SMQ-74/O1M25	16 04 75 5	
	74	M 32	no	HC-B 10-SMQ-74/O1M32	16 04 75 6	
	74	2 x M 25	no	HC-B 10-SMQ-74/O2M25	16 04 75 7	
<b>Box mounting base, for double locking latch</b>	52	2 x M 25	yes	HC-B 10-SFQD-52/O2M25	16 04 74 8	10

## Technical data

Degree of protection

IP65

Material

die-cast aluminum, powder-coated, gray

Housing

NBR

Seal

zinc-plated steel and passivated

Single locking latch

high-grade steel, handle: PA-GF

Double locking latch

Ambient temperature

[°C]

- 40 to +125

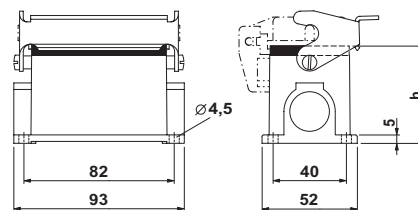

HC-B 10 SML...

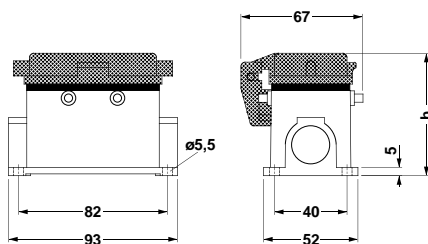

HC-B 10 SFQ...

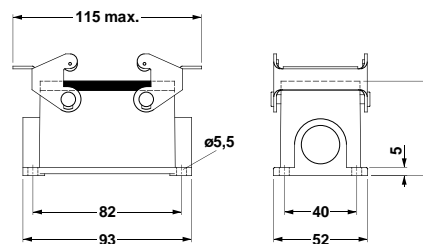

HC-B 10 SMQ...

# Type B 10, Coupling housings, with Pg screw connection



Description	Height h [mm]	Screw connection	Type	Order No.	Pcs./Pkt.
Coupling housing, with single locking latch	52	Pg 16	HC-B 10-KML-52/M1PG16	17 71 45 1	10
Coupling housing, with double locking latch	52	Pg 16	HC-B 10-KMQ-52/M1PG16	17 71 44 8	10

### Technical data

**Degree of protection**

IP65

**Material**

Housing

die-cast aluminum, powder-coated, gray

Seal

NBR

Single locking latch

zinc-plated steel and passivated

Double locking latch

high-grade steel, handle: PA-GF

**Ambient temperature**

[°C]

- 40 to +125

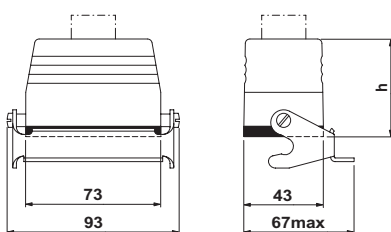

HC-B 10 KML...

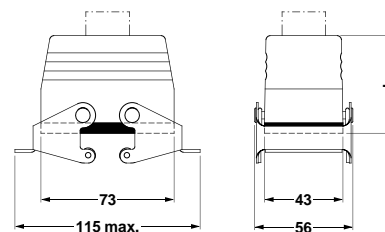

HC-B 10 KMQ...



# Type B 10, Coupling housings, for metric screw connections



Description	Height h [mm]	Screw connection	Type	Order No.	Pcs./Pkt.
Coupling housing, with single locking latch	52	M 25	HC-B 10-KML-52/O1M25	16 04 74 3	10
Coupling housing, with double locking latch	52	M 20	HC-B 10-KMQ-52/O1M20	16 04 74 5	10
	52	M 25	HC-B 10-KMQ-52/O1M25	16 04 74 6	

## Technical data

### Degree of protection

IP65

### Material

Housing

die-cast aluminum, powder-coated, gray

Seal

NBR

Single locking latch

zinc-plated steel and passivated

Double locking latch

high-grade steel, handle: PA-GF

Ambient temperature

[°C]

- 40 to +125

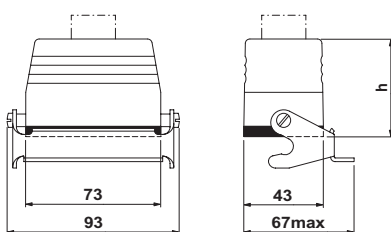

HC-B 10 KML...

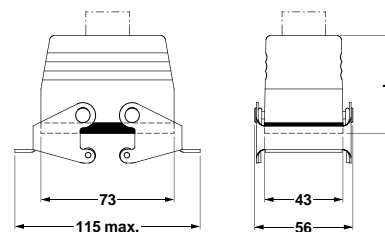

HC-B 10 KMQ...

# Type B 16, Sleeve housings, with Pg screw connection



Description	Height h [mm]	Screw connection	Cable exit	Type	Order No.	Pcs./Pkt.
<b>Sleeve housing, for single locking latch</b>	76	Pg 21	straight	HC-B 16-TFL-76/M1PG21G	17 71 57 4	10
	76	Pg 21	lateral	HC-B 16-TFL-76/M1PG21S	17 71 56 1	
	76	Pg 29	straight	HC-B 16-TFL-76/M1PG29G	17 75 60 6	
	76	Pg 29	lateral	HC-B 16-TFL-76/M1PG29S	17 75 59 6	
<b>Sleeve housing, for double locking latch</b>	76	Pg 21	straight	HC-B 16-TFQ-76/M1PG21G	17 71 51 6	10
	76	Pg 21	lateral	HC-B 16-TFQ-76/M1PG21S	17 71 50 3	
	76	Pg 29	straight	HC-B 16-TFQ-76/M1PG29G	17 75 56 7	
	76	Pg 29	lateral	HC-B 16-TFQ-76/M1PG29S	17 75 55 4	
<b>Sleeve housing, with double locking latch</b>	76	Pg 21	straight	HC-B 16-TMQ-76/M1PG21G	17 71 54 5	10
	76	Pg 21	lateral	HC-B 16-TMQ-76/M1PG21S	17 71 53 2	
	76	Pg 29	straight	HC-B 16-TMQ-76/M1PG29G	17 75 58 3	
	76	Pg 29	lateral	HC-B 16-TMQ-76/M1PG29S	17 75 57 0	

## Technical data

**Degree of protection**

IP65

**Material**

die-cast aluminum, powder-coated, gray

Housing

high-grade steel, handle: PA-GF

Double locking latch

**Ambient temperature** [°C]

- 40 to +125

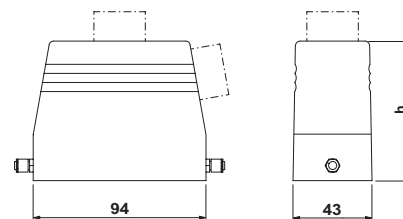

HC-B 16 TFL...

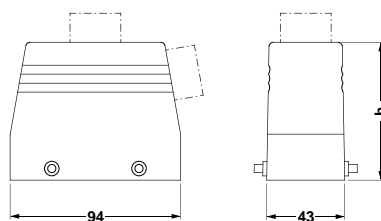

HC-B 16 TFQ...

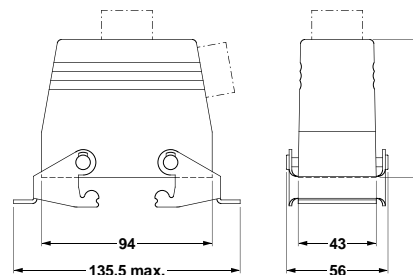

HC-B 16 TMQ...

# Type B 16, Sleeve housings, for metric screw connections



Description	Height h [mm]	Screw connection	Cable exit	Type	Order No.	Pcs./Pkt.
<b>Sleeve housing, for single locking latch</b>	45	M 25	straight	HC-B 16-TFL-45/O1M25G	16 04 79 5	10
	60	M 25	lateral	HC-B 16-TFL-60/O1M25S	16 04 79 6	
	76	M 25	straight	HC-B 16-TFL-76/O1M25G	16 04 79 8	
	76	M 25	lateral	HC-B 16-TFL-76/O1M25S	16 04 79 9	
	76	M 32	straight	HC-B 16-TFL-76/O1M32G	16 04 80 0	
	76	M 32	lateral	HC-B 16-TFL-76/O1M32S	16 04 80 1	
<b>Sleeve housing, for double locking latch</b>	45	M 25	straight	HC-B 16-TFQ-45/O1M25G	16 04 80 6	10
	60	M 25	lateral	HC-B 16-TFQ-60/O1M25S	16 04 80 7	
	76	M 25	lateral	HC-B 16-TFQ-76/O1M25S	16 04 80 9	
	76	M 32	straight	HC-B 16-TFQ-76/O1M32G	16 04 81 0	
	76	M 32	lateral	HC-B 16-TFQ-76/O1M32S	16 04 81 1	
	<b>Sleeve housing, with double locking latch</b>	65	M 25	straight	HC-B 16-TMQ-65/O1M25G	
65		M 25	lateral	HC-B 16-TMQ-65/O1M25S	16 04 81 6	
76		M 25	lateral	HC-B 16-TMQ-76/O1M25S	16 04 81 8	
76		M 32	straight	HC-B 16-TMQ-76/O1M32G	16 04 81 9	
76		M 32	lateral	HC-B 16-TMQ-76/O1M32S	16 04 82 0	

## Technical data

**Degree of protection**

IP65

**Material**

die-cast aluminum, powder-coated, gray

Housing

zinc-plated steel and passivated

Single locking latch

high-grade steel, handle: PA-GF

Double locking latch

**Ambient temperature**

[°C]

- 40 to +125

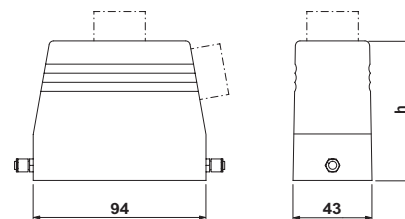

HC-B 16 TFL...

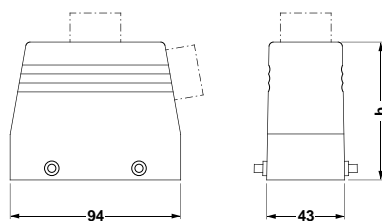

HC-B 16 TFQ...

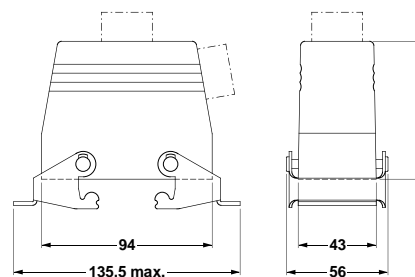

HC-B 16 TMQ...

**Type B 16,  
Sleeve housings,  
for metric screw connections,  
without support**



Description	Height h [mm]	Screw connection	Cable exit	Type	Order No.	Pcs./Pkt.
<b>Sleeve housing, for single locking latch</b>	76	M 25	straight	HC-B 16-TFL-76/O1STM25G	16 45 02 4	10
	76	M 25	lateral	HC-B 16-TFL-76/O1STM25S	16 45 03 7	
	76	M 32	straight	HC-B 16-TFL-76/O1STM32G	16 45 04 0	
	76	M 32	lateral	HC-B 16-TFL-76/O1STM32S	16 45 05 3	
	76	M 40	straight	HC-B 16-TFL-76/O1STM40G	16 44 65 6	
	76	M 40	lateral	HC-B 16-TFL-76/O1STM40S	16 44 67 2	
<b>Sleeve housing, for double locking latch</b>	76	M 25	straight	HC-B 16-TFQ-76/O1STM25G	16 45 33 8	10
	76	M 25	lateral	HC-B 16-TFQ-76/O1STM25S	16 45 06 6	
	76	M 32	straight	HC-B 16-TFQ-76/O1STM32G	16 45 07 9	
	76	M 32	lateral	HC-B 16-TFQ-76/O1STM32S	16 45 34 1	
	76	M 40	straight	HC-B 16-TFQ-76/O1STM40G	16 44 69 8	
	76	M 40	lateral	HC-B 16-TFQ-76/O1STM40S	16 44 71 1	
<b>Sleeve housing, with double locking latch</b>	76	M 40	straight	HC-B 16-TMQ-76/O1STM40G	16 44 73 7	10
	76	M 40	lateral	HC-B 16-TMQ-76/O1STM40S	16 44 75 3	

**Technical data**

**Degree of protection**  
**Material**  
Housing  
Double locking latch  
**Ambient temperature**

[°C]

IP65  
die-cast aluminum, powder-coated, gray  
high-grade steel, handle: PA-GF  
- 40 to +125

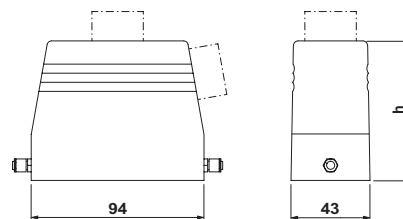

HC-B 16 TFL...

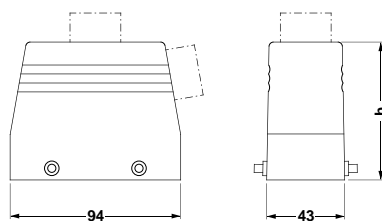

HC-B 16 TFQ...

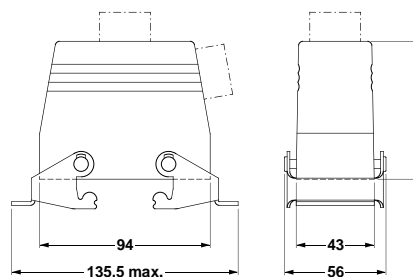

HC-B 16 TMQ...

# Type B 16, Panel mounting bases



Description	Height h [mm]	Screw connection	Protective cover	Type	Order No.	Pcs./Pkt.
Panel mounting base, with single locking latch	27	–	no	HC-B 16-AML	17 71 59 0	10
	27	–	yes	HC-B 16-AMLD	17 71 61 3	10
Panel mounting base, with double locking latch	27	–	no	HC-B 16-AMQ	17 71 58 7	10
Panel mounting base, for double locking latch	27	–	yes	HC-B 16-AFQD	17 71 60 0	10

### Technical data

Degree of protection

IP65

Material

Housing

die-cast aluminum, powder-coated, gray

Seal

NBR

Single locking latch

zinc-plated steel and passivated

Double locking latch

high-grade steel, handle: PA-GF

Ambient temperature

[°C]

– 40 to +125

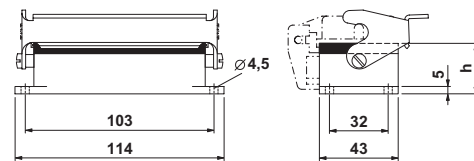

HC-B 16 AML...

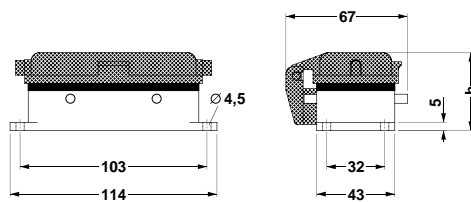

HC-B 16 AFQ...

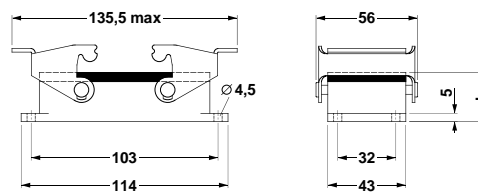

HC-B 16 AMQ...

# Type B 16, Box mounting bases, with Pg screw connection



Description	Height h [mm]	Screw connection	Protective cover	Type	Order No.	Pcs./Pkt.
<b>Box mounting base, with single locking latch</b>	67	Pg 21	no	HC-B 16-SML-67/M1PG21	17 71 64 2	10
	67	2 x Pg 21	no	HC-B 16-SML-67/M2PG21	17 71 65 5	
	67	Pg 21	yes	HC-B 16-SMLD-67/M1PG21	17 71 68 4	
	67	2 x Pg 21	yes	HC-B 16-SMLD-67/M2PG21	17 71 69 7	
<b>Box mounting base, with double locking latch</b>	67	Pg 21	no	HC-B 16-SMQ-67/M1PG21	17 71 62 6	10
	67	2 x Pg 21	no	HC-B 16-SMQ-67/M2PG21	17 71 63 9	
<b>Box mounting base, for double locking latch</b>	67	Pg 21	yes	HC-B 16-SFQD-67/M1PG21	17 71 66 8	10
	67	2 x Pg 21	yes	HC-B 16-SFQD-67/M2PG21	17 71 67 1	

## Technical data

Degree of protection

IP65

Material

die-cast aluminum, powder-coated, gray

Housing

NBR

Seal

zinc-plated steel and passivated

Single locking latch

high-grade steel, handle: PA-GF

Double locking latch

Ambient temperature

[°C]

- 40 to +125

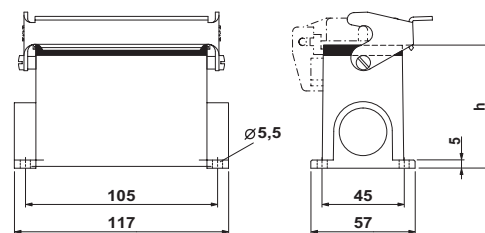

HC-B 16 SML...

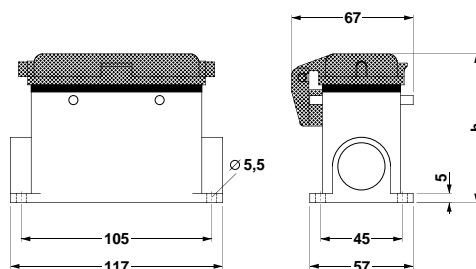

HC-B 16 SFQ...

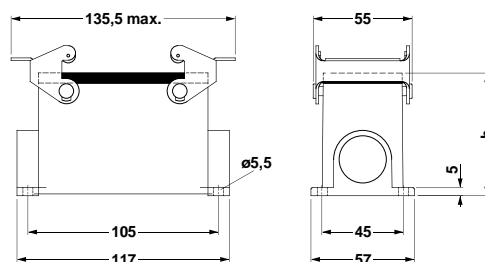

HC-B 16 SMQ...

# Type B 16, Box mounting bases, for metric screw connections



Description	Height h [mm]	Screw connection	Protective cover	Type	Order No.	Pcs./Pkt.
<b>Box mounting base, with single locking latch</b>	67	M 25	no	HC-B 16-SML-67/O1M25	16 04 78 4	10
	67	2 x M 25	no	HC-B 16-SML-67/O2M25	16 04 78 5	
	67	M 25	yes	HC-B 16-SMLD-67/O1M25	16 04 78 6	
	67	2 x M 25	yes	HC-B 16-SMLD-67/O2M25	16 04 78 7	
<b>Box mounting base, with double locking latch</b>	67	M 25	no	HC-B 16-SMQ-67/O1M25	16 04 78 8	10
	67	M 32	no	HC-B 16-SMQ-67/O1M32	16 04 78 9	
	67	2 x M 25	no	HC-B 16-SMQ-67/O2M25	16 04 79 0	
	67	2 x M 32	no	HC-B 16-SMQ-67/O2M32	16 04 79 1	
	84	M 25	no	HC-B 16-SMQ-84/O1M25	16 04 79 2	
	84	M 32	no	HC-B 16-SMQ-84/O1M32	16 04 79 3	
	84	2 x M 32	no	HC-B 16-SMQ-84/O2M32	16 04 79 4	
	<b>Box mounting base, for double locking latch</b>	67	2 x M 25	yes	HC-B 16-SFQD-67/O2M25	

## Technical data

Degree of protection

IP65

Material

die-cast aluminum, powder-coated, gray

Housing

NBR

Seal

zinc-plated steel and passivated

Single locking latch

high-grade steel, handle: PA-GF

Double locking latch

Ambient temperature

[°C]

- 40 to +125

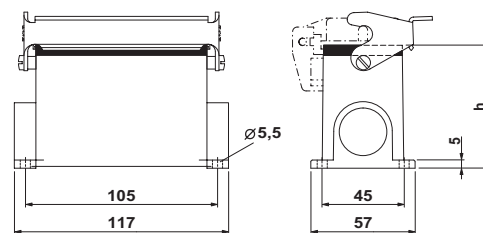

HC-B 16 SML...

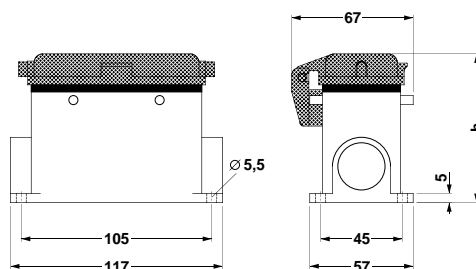

HC-B 16 SFQ...

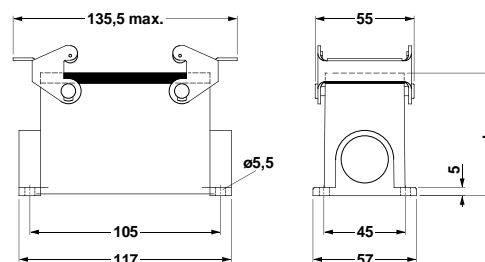

HC-B 16 SMQ...

# Type B 16, Coupling housings, with Pg screw connection



Description	Height h [mm]	Screw connection	Type	Order No.	Pcs./Pkt.
Coupling housing, with single locking latch	80	Pg 21	HC-B 16-KML-80/M1PG21	16 87 71 0	10
Coupling housing, with double locking latch	80	Pg 21	HC-B 16-KMQ-80/M1PG21	16 87 74 9	10

### Technical data

**Degree of protection**

IP65

**Material**

Housing

die-cast aluminum, powder-coated, gray

Seal

NBR

Single locking latch

zinc-plated steel and passivated

Double locking latch

high-grade steel, handle: PA-GF

**Ambient temperature**

[°C]

- 40 to +125

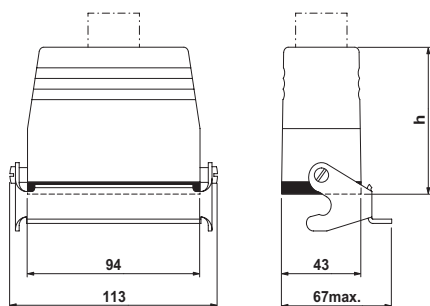

HC-B 16 KML...

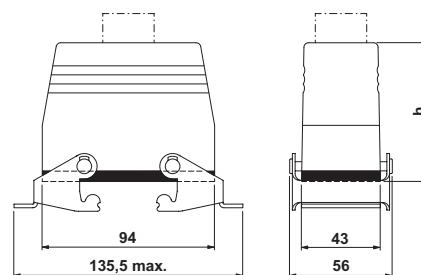

HC-B 16 KMQ...



## Type B 16, Coupling housings, for metric screw connections, with and without support



Description	Height h [mm]	Screw connection	Type	Order No.	Pcs./Pkt.
<b>Coupling housing</b> , with single locking latch, with support	80	M 32	HC-B 16-KML-80/O1M32	16 87 62 6	10
<b>Coupling housing</b> , with single locking latch, without support	80	M 40	HC-B 16-KML-80/O1STM40	16 44 79 2	10
<b>Coupling housing</b> , with double locking latch, with support	80	M 32	HC-B 16-KMQ-80/O1M32	16 04 96 8	10
<b>Coupling housing</b> , with double locking latch, without support	80	M 40	HC-B 16-KMQ-80/O1STM40	16 44 77 9	10

### Technical data

#### Degree of protection

IP65

#### Material

Housing

die-cast aluminum, powder-coated, gray

Seal

NBR

Single locking latch

zinc-plated steel and passivated

Double locking latch

high-grade steel, handle: PA-GF

Ambient temperature

[°C]

-40 to +125

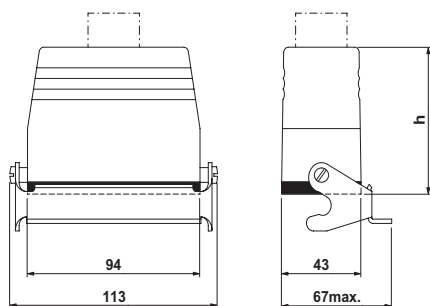

HC-B 16 KML...

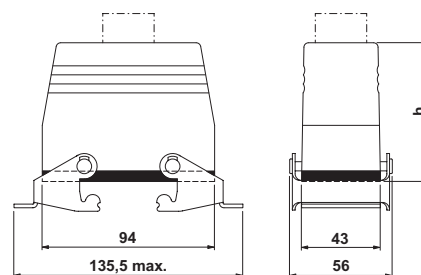

HC-B 16 KMQ...

# Type B 24, Sleeve housings, with Pg screw connection



Description	Height h [mm]	Screw connection	Cable exit	Type	Order No.	Pcs./Pkt.
<b>Sleeve housing, for single locking latch</b>	76	Pg 21	straight	HC-B 24-TFL-76/M1PG21G	17 71 90 1	10
	76	Pg 21	lateral	HC-B 24-TFL-76/M1PG21S	17 71 88 8	
	76	Pg 29	straight	HC-B 24-TFL-76/M1PG29G	17 71 91 4	
	76	Pg 29	lateral	HC-B 24-TFL-76/M1PG29S	17 71 89 1	
<b>Sleeve housing, for double locking latch</b>	60	Pg 21	lateral	HC-B 24-TFQ-60/M1PG21S	16 61 48 0	10
	76	Pg 21	straight	HC-B 24-TFQ-76/M1PG21G	17 71 78 1	
	76	Pg 21	lateral	HC-B 24-TFQ-76/M1PG21S	17 71 76 5	
	76	Pg 29	straight	HC-B 24-TFQ-76/M1PG29G	17 71 79 4	
	76	Pg 29	straight	HC-B 24-TFQ-76/M1PG29S	17 71 77 8	
	76	Pg 29	lateral	HC-B 24-TFQ-76/M1PG29S	17 71 77 8	
<b>Sleeve housing, with double locking latch</b>	76	Pg 21	straight	HC-B 24-TMQ-76/M1PG21G	17 71 84 6	10
	76	Pg 21	lateral	HC-B 24-TMQ-76/M1PG21S	17 71 82 0	
	76	Pg 29	straight	HC-B 24-TMQ-76/M1PG29G	17 71 85 9	
	76	Pg 29	lateral	HC-B 24-TMQ-76/M1PG29S	17 71 83 3	

### Technical data

Degree of protection

IP65

Material

die-cast aluminum, powder-coated, gray

Housing

high-grade steel, handle: PA-GF

Double locking latch

Ambient temperature

[°C]

- 40 to +125

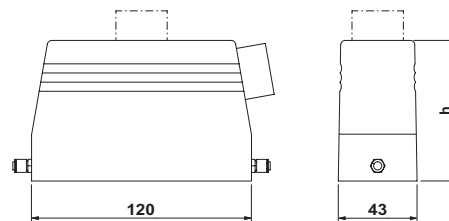

HC-B 24 TFL...

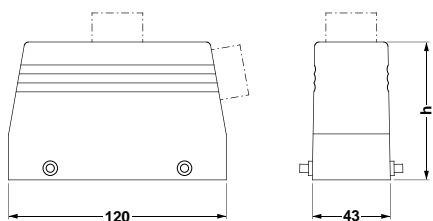

HC-B 24 TFQ...

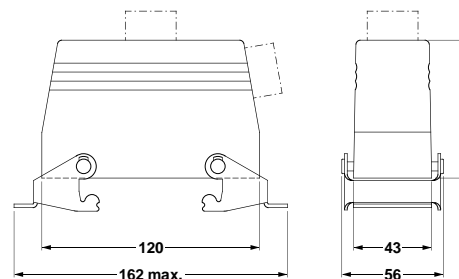

HC-B 24 TMQ...

# Type B 24, Sleeve housings, for metric screw connections



Description	Height h [mm]	Screw connection	Cable exit	Type	Order No.	Pcs./Pkt.
<b>Sleeve housing, for single locking latch</b>	56	M 25	straight	HC-B 24-TFL-56/O1M25G	16 04 83 9	10
	60	M 25	lateral	HC-B 24-TFL-60/O1M25S	16 04 84 0	
	60	M 32	lateral	HC-B 24-TFL-60/O1M32S	16 04 84 1	
	76	M 25	straight	HC-B 24-TFL-76/O1M25G	16 04 84 2	
	76	M 32	straight	HC-B 24-TFL-76/O1M32G	16 04 84 3	
	76	M 32	lateral	HC-B 24-TFL-76/O1M32S	16 04 84 4	
<b>Sleeve housing, for double locking latch</b>	56	M 25	straight	HC-B 24-TFQ-56/O1M25G	16 04 84 7	10
	56	M 32	straight	HC-B 24-TFQ-56/O1M32G	16 04 84 8	
	60	M 25	lateral	HC-B 24-TFQ-60/O1M25S	16 04 84 9	
	60	M 32	lateral	HC-B 24-TFQ-60/O1M32S	16 04 85 0	
	76	M 25	straight	HC-B 24-TFQ-76/O1M25G	16 04 85 1	
	76	M 25	lateral	HC-B 24-TFQ-76/O1M25S	16 04 85 2	
	76	M 32	straight	HC-B 24-TFQ-76/O1M32G	16 04 85 3	
	76	M 32	lateral	HC-B 24-TFQ-76/O1M32S	16 04 85 4	
<b>Sleeve housing, with double locking latch</b>	76	M 25	straight	HC-B 24-TMQ-76/O1M25G	16 04 85 8	10
	76	M 25	lateral	HC-B 24-TMQ-76/O1M25S	16 04 85 9	
	76	M 32	straight	HC-B 24-TMQ-76/O1M32G	16 04 86 0	

## Technical data

**Degree of protection**  
**Material**  
Housing  
Double locking latch  
**Ambient temperature**

[°C]

IP65

die-cast aluminum, powder-coated, gray  
high-grade steel, handle: PA-GF  
- 40 to +125

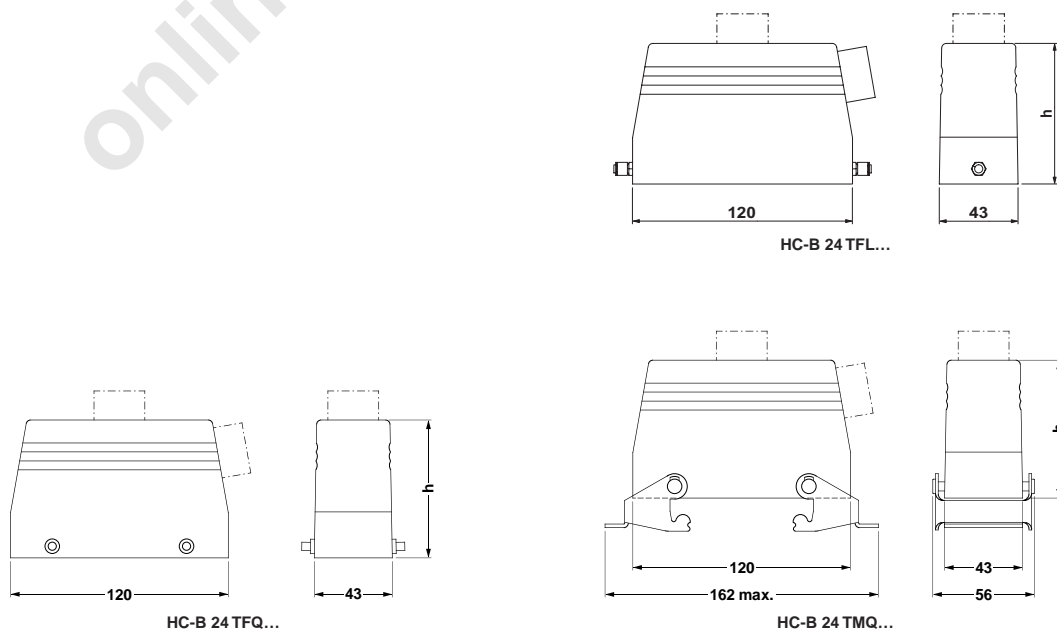

**Type B 24,  
Sleeve housings,  
for metric screw connections,  
without support**



Description	Height h [mm]	Screw connection	Cable exit	Type	Order No.	Pcs./Pkt.
<b>Sleeve housing, for single locking latch</b>	76	M 25	straight	HC-B 24-TFL-76/O1STM25G	16 45 08 2	10
	76	M 25	lateral	HC-B 24-TFL-76/O1STM25S	16 45 35 4	
	76	M 32	straight	HC-B 24-TFL-76/O1STM32G	16 45 36 7	
	76	M 32	lateral	HC-B 24-TFL-76/O1STM32S	16 45 37 0	
	76	M 40	straight	HC-B 24-TFL-76/O1STM40G	16 44 66 9	
	76	M 40	lateral	HC-B 24-TFL-76/O1STM40S	16 44 68 5	
	76	2 x M 40	straight	HC-B 24-TFL-76/O2STM40G	16 45 44 8	
<b>Sleeve housing, for double locking latch</b>	76	M 25	straight	HC-B 24-TFQ-76/O1STM25G	16 45 09 5	10
	76	M 25	lateral	HC-B 24-TFQ-76/O1STM25S	16 45 10 5	
	76	M 32	straight	HC-B 24-TFQ-76/O1STM32G	16 45 11 8	
	76	M 32	lateral	HC-B 24-TFQ-76/O1STM32S	16 45 12 1	
	76	M 40	straight	HC-B 24-TFQ-76/O1STM40G	16 44 70 8	
	76	M 40	lateral	HC-B 24-TFQ-76/O1STM40S	16 44 72 4	
<b>Sleeve housing, with double locking latch</b>	76	M 40	straight	HC-B 24-TMQ-76/O1STM40G	16 44 74 0	10
	76	M 40	lateral	HC-B 24-TMQ-76/O1STM40S	16 44 76 6	

**Technical data**

**Degree of protection**  
**Material**  
Housing  
Double locking latch  
**Ambient temperature**

IP65  
die-cast aluminum, powder-coated, gray  
high-grade steel, handle: PA-GF  
- 40 to +125

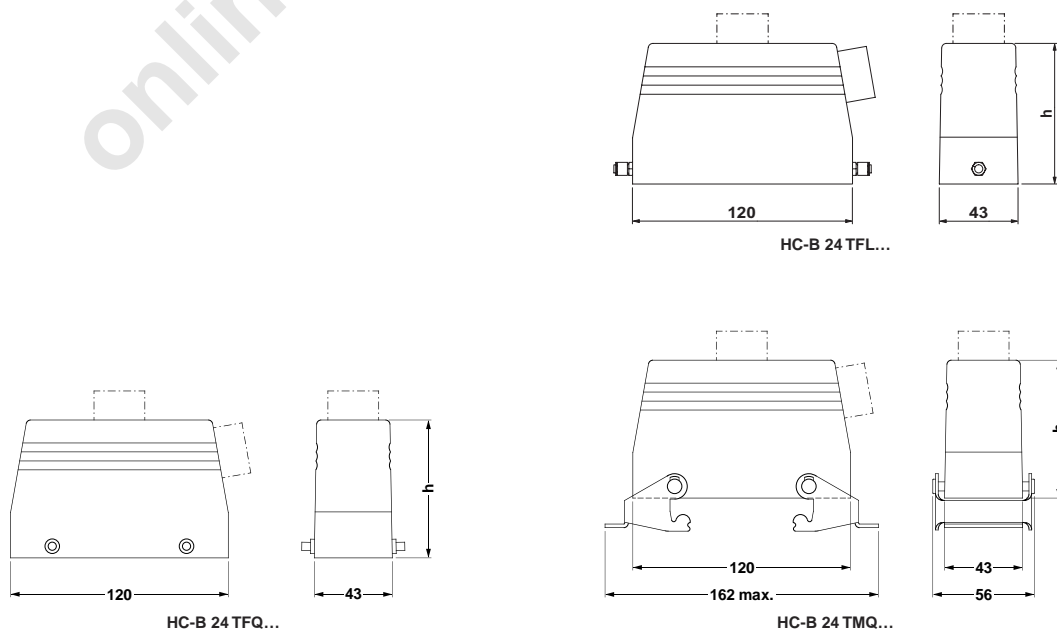

# Type B 24, Panel mounting bases



Description	Height h [mm]	Screw connection	Protective cover	Type	Order No.	Pcs./Pkt.
Panel mounting base, with single locking latch	27	–	no	HC-B 24-AML	17 71 93 0	10
	27	–	yes	HC-B 24-AMLD	17 71 94 3	
Panel mounting base, with double locking latch	27	–	no	HC-B 24-AMQ	17 71 92 7	10
Panel mounting base, for double locking latch	27	–	yes	HC-B 24-AFQD	17 71 95 6	10

### Technical data

Degree of protection

IP65

Material

Housing

die-cast aluminum, powder-coated, gray

Seal

NBR

Single locking latch

zinc-plated steel and passivated

Double locking latch

high-grade steel, handle: PA-GF

Ambient temperature

[°C]

– 40 to +125

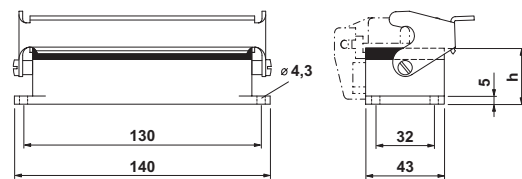

HC-B 24 AML...

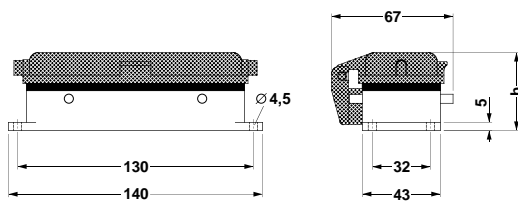

HC-B 24 AFQ...

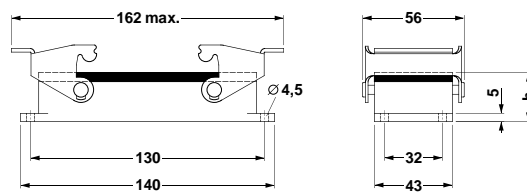

HC-B 24 AMQ...

# Type B 24, Box mounting bases, with Pg screw connection



Description	Height h [mm]	Screw connection	Protective cover	Type	Order No.	Pcs./Pkt.
<b>Box mounting base, with single locking latch</b>	67	Pg 21	no	HC-B 24-SML-67/M1PG21	17 71 98 5	10
	67	2 x Pg 21	no	HC-B 24-SML-67/M2PG21	17 71 99 8	
	67	Pg 21	yes	HC-B 24-SMLD-67/M1PG21	17 72 03 6	
	67	2 x Pg 21	yes	HC-B 24-SMLD-67/M2PG21	17 72 04 9	
<b>Box mounting base, with double locking latch</b>	67	Pg 21	no	HC-B 24-SMQ-67/M1PG21	17 71 96 9	10
	67	2 x Pg 21	no	HC-B 24-SMQ-67/M2PG21	17 71 97 2	
<b>Box mounting base, for double locking latch</b>	67	Pg 21	yes	HC-B 24-SFQD-67/M1PG21	17 72 01 0	10
	67	2 x Pg 21	yes	HC-B 24-SFQD-67/M2PG21	17 72 02 3	

## Technical data

### Degree of protection

IP65

### Material

#### Housing

die-cast aluminum, powder-coated, gray

#### Seal

NBR

#### Single locking latch

zinc-plated steel and passivated

#### Double locking latch

high-grade steel, handle: PA-GF

### Ambient temperature

[°C]

- 40 to +125

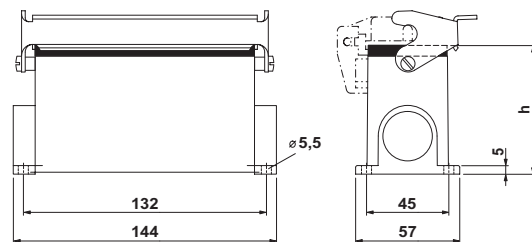

HC-B 24 SML...

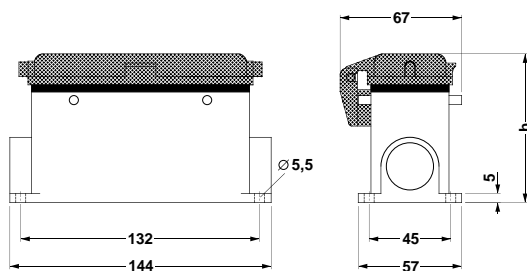

HC-B 24 SFQ...

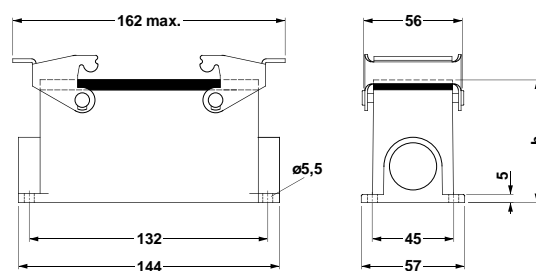

HC-B 24 SMQ...

# Type B 24, Box mounting bases, for metric screw connections



Description	Height h [mm]	Screw connection	Protective cover	Type	Order No.	Pcs./Pkt.
<b>Box mounting base, with single locking latch</b>	84	M 32	no	HC-B 24-SML-84/O2M32	16 04 83 2	10
	67	M 25	yes	HC-B 24-SMLD-67/O1M25	16 04 83 3	
	67	M 25	yes	HC-B 24-SMLD-67/O2M25	16 04 83 4	
<b>Box mounting base, with double locking latch</b>	67	M 25	no	HC-B 24-SMQ-67/O1M25	16 04 83 5	10
	84	M 32	no	HC-B 24-SMQ-84/O1M32	16 04 83 6	
	84	2 x M 32	no	HC-B 24-SMQ-84/O2M32	16 04 83 7	
<b>Box mounting base, for double locking latch</b>	67	M 25	yes	HC-B 24-SFQD-67/O1M25	16 04 83 0	10
	67	2 x M 25	yes	HC-B 24-SFQD-67/O2M25	16 04 83 1	

## Technical data

**Degree of protection**

IP65

**Material**

Housing

die-cast aluminum, powder-coated, gray

Seal

NBR

Single locking latch

zinc-plated steel and passivated

Double locking latch

high-grade steel, handle: PA-GF

**Ambient temperature**

[°C]

- 40 to +125

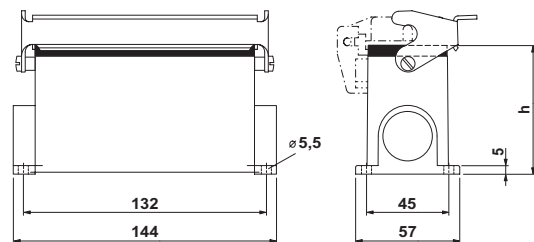

HC-B 24 SML...

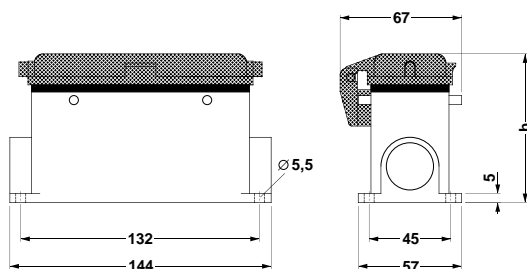

HC-B 24 SFQ...

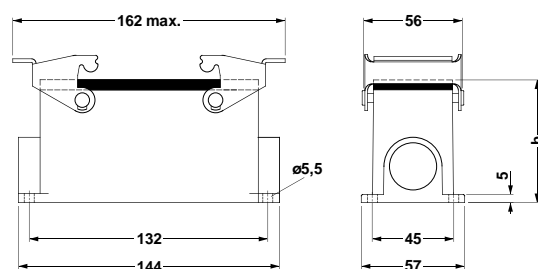

HC-B 24 SMQ...

# Type B 24, Coupling housings, with Pg screw connection



Description	Height h [mm]	Screw connection	Type	Order No.	Pcs./Pkt.
Coupling housing, with single locking latch	79	Pg 21	HC-B 24-KML-79/M1PG21	17 72 07 8	10
	79	Pg 29	HC-B 24-KML-79/M1PG29	17 72 08 1	
Coupling housing, with double locking latch	79	Pg 21	HC-B 24-KMQ-79/M1PG21	17 72 05 2	10
	79	Pg 29	HC-B 24-KMQ-79/M1PG29	17 72 06 5	

### Technical data

**Degree of protection**

IP65

**Material**

Housing

die-cast aluminum, powder-coated, gray

Seal

NBR

Single locking latch

zinc-plated steel and passivated

Double locking latch

high-grade steel, handle: PA-GF

**Ambient temperature**

[°C]

-40 to +125

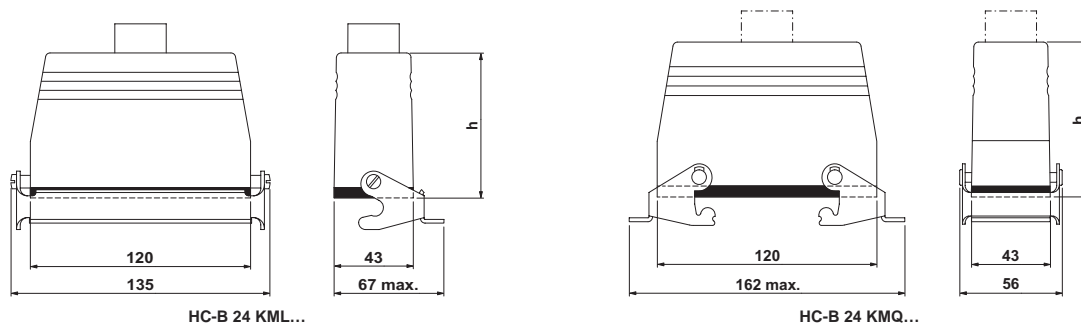

HC-B 24 KML...

HC-B 24 KMQ...



## Type B 24, Coupling housings, for metric screw connections, with and without support



Description	Height h [mm]	Screw connection	Type	Order No.	Pcs./Pkt.
<b>Coupling housing</b> , with single locking latch, with support	80	M 25	HC-B 24-KML-80/O1M25	16 04 82 3	10
	80	M 32	HC-B 24-KML-80/O1M32	16 04 82 4	10
<b>Coupling housing</b> , with single locking latch, without support	80	M 40	HC-B 24-KML-80/O1MST40	16 44 80 5	10
<b>Coupling housing</b> , with double locking latch, with support	80	M 25	HC-B 24-KMQ-80/O1M25	16 04 82 7	10
	80	M 40	HC-B 24-KMQ-80/O1MST40	16 44 78 2	10

### Technical data

**Degree of protection**  
**Material**  
Housing  
Seal  
Single locking latch  
Double locking latch  
**Ambient temperature**

[°C]

IP65

die-cast aluminum, powder-coated, gray  
NBR  
zinc-plated steel and passivated  
high-grade steel, handle: PA-GF  
- 40 to +125

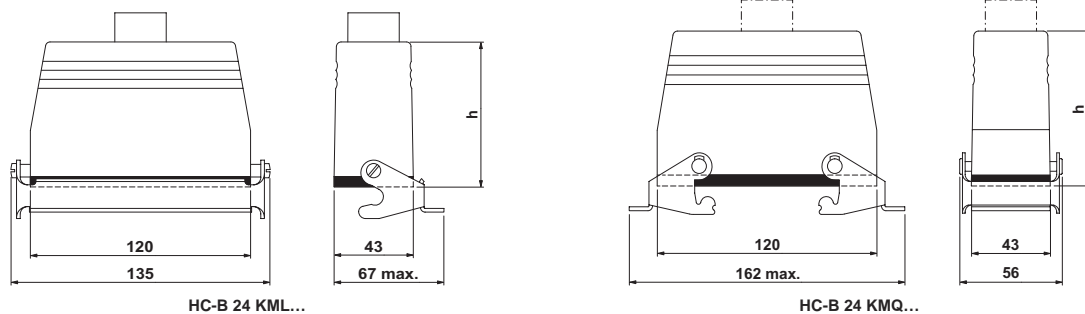

HC-B 24 KML...

HC-B 24 KMQ...

**Type B 32,  
Sleeve housings,  
with Pg screw connection**



Description	Height h [mm]	Screw connection	Cable exit	Type	Order No.	Pcs./Pkt.
<b>Sleeve housing, for double locking latch</b>	80	Pg 21	straight	HC-B 32-TFQ-80/M1PG21G	17 75 67 7	10
	80	Pg 21	lateral	HC-B 32-TFQ-80/M1PG21S	17 75 65 1	
	80	Pg 29	straight	HC-B 32-TFQ-80/M1PG29G	17 75 68 0	
	80	Pg 29	lateral	HC-B 32-TFQ-80/M1PG29S	17 75 66 4	
<b>Technical data</b>						
<b>Degree of protection</b>	IP65					
<b>Material</b>	die-cast aluminum, powder-coated, gray					
<b>Housing</b>						
<b>Ambient temperature</b>	[°C] - 40 to +125					

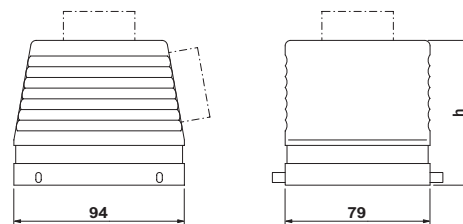

HC-B 32 TFQ...

**Type B 32,  
Sleeve housings,  
for metric screw connections**



Description	Height h [mm]	Screw connection	Cable exit	Type	Order No.	Pcs./Pkt.
<b>Sleeve housing</b> , for double locking latch	80	M 25	straight	HC-B 32-TFQ-80/O1M25G	<b>16 04 87 0</b>	10
	80	M 25	lateral	HC-B 32-TFQ-80/O1M25S	<b>16 04 87 1</b>	
	80	M 32	lateral	HC-B 32-TFQ-80/O1M32S	<b>16 04 87 2</b>	
<b>Technical data</b>						
<b>Degree of protection</b>	IP65					
<b>Material</b>	die-cast aluminum, powder-coated, gray					
<b>Housing</b>						
<b>Ambient temperature</b>	[°C] - 40 to +125					

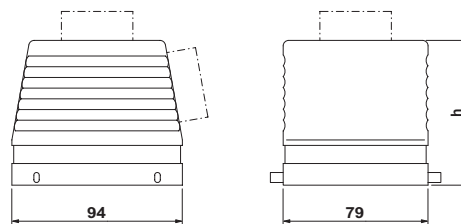

HC-B 32 TFQ...

**Type B 32,  
Sleeve housings,  
for metric screw connections,  
without support**



Description	Height h [mm]	Screw connection	Cable exit	Type	Order No.	Pcs./Pkt.
<b>Sleeve housing</b> , for double locking latch	80	M 25	straight	HC-B 32-TFQ-80/O1M25G	16 45 13 4	10
	80	M 25	lateral	HC-B 32-TFQ-80/O1M25S	16 45 14 7	
	80	M 32	straight	HC-B 32-TFQ-80/O1M32G	16 45 38 3	
	80	M 32	lateral	HC-B 32-TFQ-80/O1M32S	16 45 15 0	
	80	M 40	lateral	HC-B 32-TFQ-80/O1M40S	16 45 45 1	

**Technical data**

**Degree of protection**

IP65

**Material**

die-cast aluminum, powder-coated, gray

Housing

**Ambient temperature**

[°C]

- 40 to +125

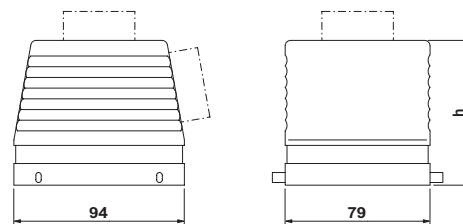

HC-B 32 TFQ...

# Type B 32, Panel mounting bases



Description	Height h [mm]	Screw connection	Protective cover	Type	Order No.	Pcs./Pkt.
Panel mounting base, with double locking latch	30	-	no	HC-B 32-AMQ	17 75 69 3	10
<b>Technical data</b>						
Degree of protection	IP65					
Material	die-cast aluminum, powder-coated, gray					
Housing	NBR					
Seal	high-grade steel, handle: PA-GF					
Double locking latch	- 40 to +125					
Ambient temperature	[°C]					

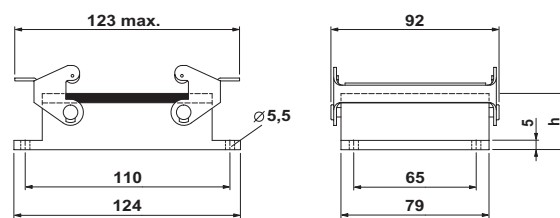

HC-B 32 AMQ...

# Type B 32, Box mounting base, with Pg screw connection



Description	Height h [mm]	Screw connection	Protective cover	Type	Order No.	Pcs./Pkt.
<b>Box mounting base, with double locking latch</b>	72	Pg 29 2 x Pg 29	no no	<b>HC-B 32-SMQ-72/M1PG29</b> <b>HC-B 32-SMQ-72/M2PG29</b>	<b>17 75 70 3</b> <b>17 75 71 6</b>	10
<b>Technical data</b>						
<b>Degree of protection</b>	IP65					
<b>Material</b>	die-cast aluminum, powder-coated, gray					
Housing	NBR					
Seal	high-grade steel, handle: PA-GF					
Double locking latch	- 40 to +125					
<b>Ambient temperature</b>	[°C]					

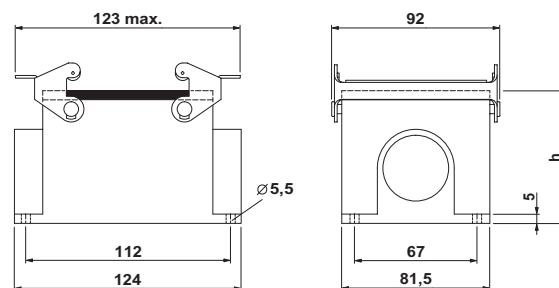

HC-B 32 SMQ...

**Type B 32,  
Box mounting bases,  
for metric screw connections**



Description	Height h [mm]	Screw connection	Protective cover	Type	Order No.	Pcs./Pkt.
<b>Box mounting base, with double locking latch</b>	72	M 32	no	HC-B 32-SMQ-72/O1M32	16 04 86 7	10
	72	2 x M 32	no	HC-B 32-SMQ-72/O2M32	16 04 86 8	
	72	2 x M 40	no	HC-B 32-SMQ-72/O2M40	16 04 86 9	

**Technical data**

**Degree of protection**

IP65

**Material**

die-cast aluminum, powder-coated, gray

Housing

NBR

Seal

high-grade steel, handle: PA-GF

Double locking latch

**Ambient temperature**

[°C]

- 40 to +125

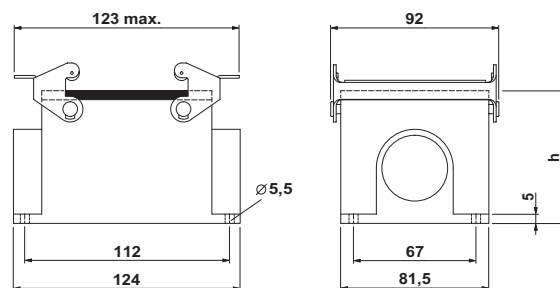

HC-B 32 SMQ...

# Type B 32, Coupling housings, with Pg screw connection



Description	Height h [mm]	Screw connection	Type	Order No.	Pcs./Pkt.
Coupling housing, with double locking latch	82	Pg 21	HC-B 32-KMQ-82/M1PG21	17 75 72 9	10
	82	Pg 29	HC-B 32-KMQ-82/M1PG29	17 75 73 2	
<b>Technical data</b>					
<b>Degree of protection</b>				IP65	
<b>Material</b>				die-cast aluminum, powder-coated, gray	
Housing				NBR	
Seal				high-grade steel, handle: PA-GF	
Double locking latch				- 40 to +125	
<b>Ambient temperature</b>		[°C]			

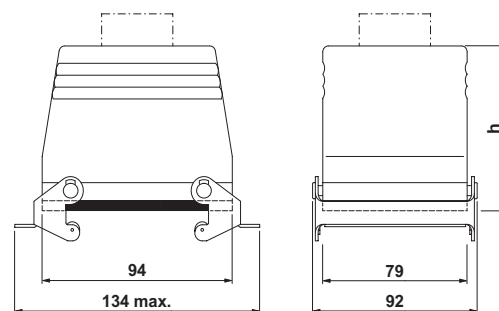

HC-B 32 KMQ...



# Type B 32, Coupling housings, for metric screw connections



Description	Height h [mm]	Screw connection	Type	Order No.	Pcs./Pkt.
Coupling housing, with double locking latch	82	M 25	HC-B 32-KMQ-82/O1M25	16 04 86 3	10
	82	M 32	HC-B 32-KMQ-82/O1M32	16 04 86 4	
<b>Technical data</b>					
Degree of protection	IP65				
Material	die-cast aluminum, powder-coated, gray				
Housing	NBR				
Seal	high-grade steel, handle: PA-GF				
Double locking latch	- 40 to +125				
Ambient temperature	[°C]				

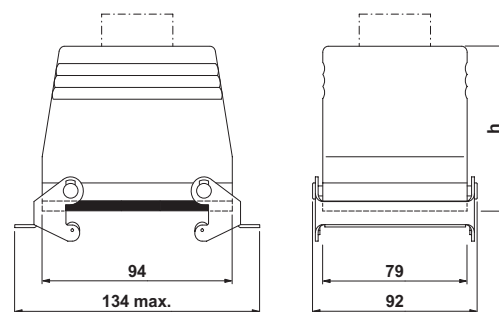

HC-B 32 KMQ...

**Type B 48,  
Sleeve housings,  
with Pg screw connection**



Description	Height h [mm]	Screw connection	Cable exit	Type	Order No.	Pcs./Pkt.
<b>Sleeve housing</b> , for single locking latch	96	Pg 29	straight	HC-B 48-TFL-96/M1PG29G	17 72 15 9	10
	96	Pg 29	lateral	HC-B 48-TFL-96/M1PG29S	17 72 13 3	
	96	Pg 36	straight	HC-B 48-TFL-96/M1PG36G	17 72 16 2	
	96	Pg 36	lateral	HC-B 48-TFL-96/M1PG36S	17 72 14 6	

**Technical data**

**Degree of protection**

IP65

**Material**

die-cast aluminum, powder-coated, gray

Housing

**Ambient temperature**

[°C]

- 40 to +125

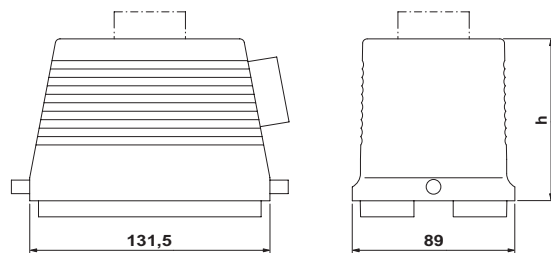

HC-B 48 TFL...

**Type B 48,  
Sleeve housings,  
for metric screw connections**



Description	Height h [mm]	Screw connection	Cable exit	Type	Order No.	Pcs./Pkt.
<b>Sleeve housing</b> , for single locking latch	96	M 40	straight	HC-B 48-TFL-96/O1M40G	<b>16 04 87 9</b>	10
	96	M 40	lateral	HC-B 48-TFL-96/O1M40S	<b>16 04 88 0</b>	
<b>Technical data</b>						
<b>Degree of protection</b>	IP65					
<b>Material</b>	die-cast aluminum, powder-coated, gray					
<b>Housing</b>						
<b>Ambient temperature</b>	- 40 to +125 [°C]					

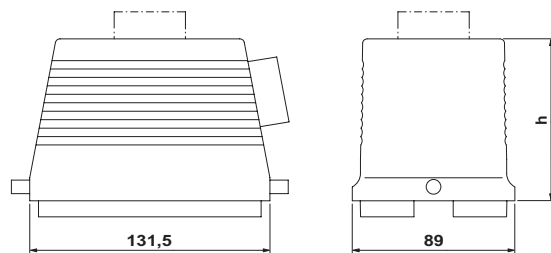

HC-B 48 TFL...

# Type B 48, Panel mounting bases



Description	Height h [mm]	Screw connection	Protective cover	Type	Order No.	Pcs./Pkt.
Panel mounting base, with single locking latch	41	–	no	HC-B 48-AML	17 72 17 5	10
	41	–	yes	HC-B 48-AML D	17 72 18 8	
<b>Technical data</b>						
Degree of protection					IP65	
Material					die-cast aluminum, powder-coated, gray	
Housing					NBR	
Seal					zinc-plated steel and passivated	
Single locking latch					– 40 to +125	
Ambient temperature			[°C]			

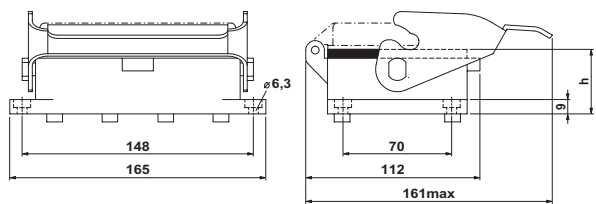

HC-B 48 AML...

# Type B 48, Box mounting bases, with Pg screw connection



Description	Height h [mm]	Screw connection	Protective cover	Type	Order No.	Pcs./Pkt.
<b>Box mounting base, with single locking latch</b>	100	Pg 29	no	HC-B 48-SML-100/M1PG29	17 72 19 1	10
	100	2 x Pg 29	no	HC-B 48-SML-100/M2PG29	17 72 20 1	
	100	Pg 29	yes	HC-B 48-SMLD-100/M1PG29	17 72 21 4	
	100	2 x Pg 29	yes	HC-B 48-SMLD-100/M2PG29	17 72 22 7	

## Technical data

**Degree of protection**

IP65

**Material**

die-cast aluminum, powder-coated, gray

Housing

NBR

Seal

zinc-plated steel and passivated

Single locking latch

**Ambient temperature**

[°C]

- 40 to +125

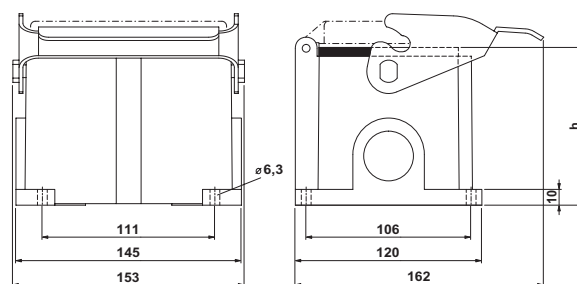

HC-B 48 SML...

# Type B 48, Box mounting bases, for metric screw connections



Description	Height h [mm]	Screw connection	Protective cover	Type	Order No.	Pcs./Pkt.
<b>Box mounting base, with single locking latch</b>	100	M 32	no	HC-B 48-SML-100/O1M32	16 04 87 5	10
	100	2 x M 40	no	HC-B 48-SML-100/O2M40	16 04 87 6	
	100	M 32	yes	HC-B 48-SMLD-100/O1M32	16 04 87 7	
	100	2 x M 40	yes	HC-B 48-SMLD-100/O2M40	16 04 87 8	
<b>Technical data</b>						
<b>Degree of protection</b>	IP65					
<b>Material</b>	die-cast aluminum, powder-coated, gray					
<b>Housing</b>	NBR					
<b>Seal</b>	zinc-plated steel and passivated					
<b>Single locking latch</b>	- 40 to +125					
<b>Ambient temperature</b>	[°C]					

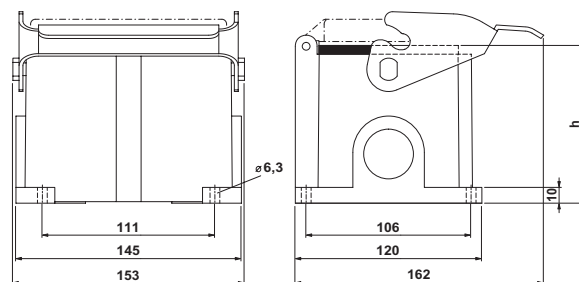

HC-B 48 SML...