

CD4021BC 8-Stage Static Shift Register

General Description

The CD4021BC is an 8-stage parallel input/serial output shift register. A parallel/serial control input enables individual JAM inputs to each of 8 stages. Q outputs are available from the sixth, seventh, and eighth stages. All outputs have equal source and sink current capabilities and conform to standard "B" series output drive.

When the parallel/serial control input is in the logical "0" state, data is serially shifted into the register synchronously with the positive transition of the clock. When the parallel/serial control is in the logical "1" state, data is jammed into each stage of the register asynchronously with the clock.

All inputs are protected against static discharge with diodes to V_{DD} and V_{SS} .

Features

- Wide supply voltage range: 3.0V to 15V
- High noise immunity: 0.45 V_{DD} (typ.)
- Low power TTL compatibility:
 - Fan out of 2 driving 74L or 1 driving 74LS
- 5V–10V–15V parametric ratings
- Symmetrical output characteristics
- Maximum input leakage 1 μ A at 15V over full temperature range

Ordering Code:

Order Number	Order Code	Package Description
CD4021BCM	M16A	16-Lead Small Outline Integrated Circuit (SOIC), JEDEC MS-012, 0.150" Narrow
CD4021BCN	N16E	16-Lead Plastic Dual-In-Line Package (PDIP), JEDEC MS-001, 0.300" Wide

Devices also available in Tape and Reel. Specify by appending the suffix letter "X" to the ordering code.

Connection Diagram

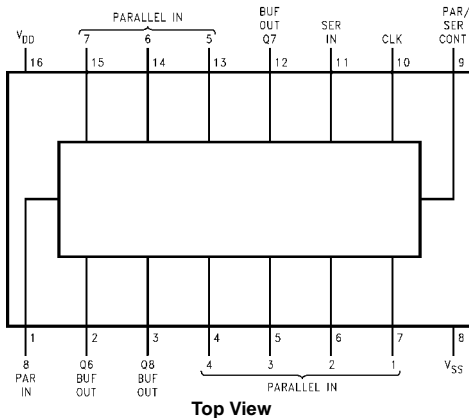

Truth Table

C_L (Note 1)	Serial Input	Parallel/ Serial Control	PI 1	PI n	Q1 (Internal)	Q_n (Note 2)
X	X	1	0	0	0	0
X	X	1	0	1	0	1
X	X	1	1	0	1	0
X	X	1	1	1	1	1
↘	0	0	X	X	0	Q_{n-1}
↘	1	0	X	X	1	Q_{n-1}
↘	X	0	X	X	Q_1	Q_n

X = Don't care case

Note 1: Level change

Note 2: No change

CD4021BC

Logic Diagram

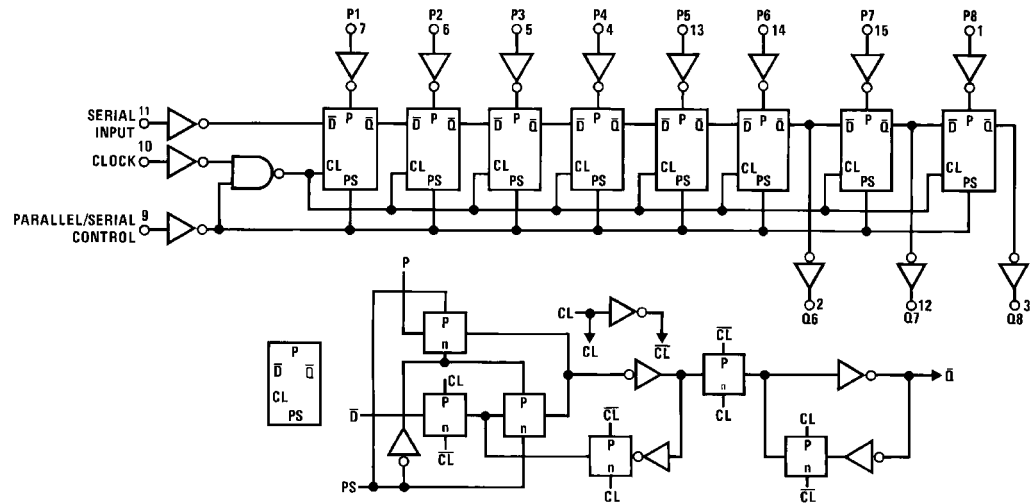

Absolute Maximum Ratings(Note 3)

(Note 4)

Supply Voltage (V_{DD})	-0.5V to +18V
Input Voltage (V_{IN})	-0.5V to $V_{DD} + 0.5V$
Storage Temperature Range (T_S)	-65°C to +150°C
Power Dissipation (P_D)	
Dual-In-Line	700 mW
Small Outline	500 mW
Lead Temperature (T_L)	
(Soldering, 10 seconds)	260°C

Recommended Operating Conditions (Note 4)

Supply Voltage (V_{DD})	3V to 15V
Input Voltage (V_{IN})	0 to V_{DD}
Operating Temperature Range (T_A)	
CD4021BCN	-55°C to +125°C

Note 3: "Absolute Maximum Ratings" are those values beyond which the safety of the device cannot be guaranteed. Except for "Operating Temperature Range" they are not meant to imply that the devices should be operated at these limits. The table of "Electrical Characteristics" provides conditions for actual device operation.

Note 4: $V_{SS} = 0V$ unless otherwise specified.

DC Electrical Characteristics (Note 4)

Symbol	Parameter	Conditions	-55°C		+25°C			+125°C		Units
			Min	Max	Min	Typ	Max	Min	Max	
I_{DD}	Quiescent Device Current	$V_{DD} = 5V, V_{IN} = V_{DD}$ or V_{SS}		5		0.1	5		150	μA
		$V_{DD} = 10V, V_{IN} = V_{DD}$ or V_{SS}		10		0.2	10		300	
		$V_{DD} = 15V, V_{IN} = V_{DD}$ or V_{SS}		20		0.3	20		600	
V_{OL}	LOW Level Output Voltage	$V_{DD} = 5V$		0.05		0	0.05		0.05	V
		$V_{DD} = 10V$ $ I_O < 1 \mu A$		0.05		0	0.05		0.05	
		$V_{DD} = 15V$		0.05		0	0.05		0.05	
V_{OH}	HIGH Level Output Voltage	$V_{DD} = 5V$	4.95		4.95	5		4.95		V
		$V_{DD} = 10V$ $ I_O < 1 \mu A$	9.95		9.95	10		9.95		
		$V_{DD} = 15V$	14.95		14.95	15		14.95		
V_{IL}	LOW Level Input Voltage	$V_{DD} = 5V, V_O = 0.5V$ or $4.5V$		1.5		2	1.5		1.5	V
		$V_{DD} = 10V, V_O = 1.0V$ or $9.0V$		3.0		4	3.0		3.0	
		$V_{DD} = 15V, V_O = 1.5V$ or $13.5V$		4.0		6	4.0		4.0	
V_{IH}	HIGH Level Input Voltage	$V_{DD} = 5V, V_O = 0.5V$ or $4.5V$	3.5		3.5	3		3.5		V
		$V_{DD} = 10V, V_O = 1.0V$ or $9.0V$	7.0		7.0	6		7.0		
		$V_{DD} = 15V, V_O = 1.5V$ or $13.5V$	11.0		11.0	9		11.0		
I_{OL}	LOW Level Output Current (Note 5)	$V_{DD} = 5V, V_O = 0.4V$	0.64		0.51	0.88		0.36		mA
		$V_{DD} = 10V, V_O = 0.5V$	1.6		1.3	2.2		0.90		
		$V_{DD} = 15V, V_O = 1.5V$	4.2		3.4	8		2.4		
I_{OH}	HIGH Level Output Current (Note 5)	$V_{DD} = 5V, V_O = 4.6V$	-0.64		-0.51	-0.88		-0.36		mA
		$V_{DD} = 10V, V_O = 9.5V$	-1.6		-1.3	-2.2		-0.90		
		$V_{DD} = 15V, V_O = 13.5V$	-4.2		-3.4	-8		-2.4		
I_{IN}	Input Current	$V_{DD} = 15V, V_{IN} = 0V$		-0.1		-10^{-5}	-0.1		-1.0	μA
		$V_{DD} = 15V, V_{IN} = 15V$		0.1		10^{-5}	0.1		1.0	

Note 5: I_{OH} and I_{OL} are tested one output at a time.

AC Electrical Characteristics (Note 6)T_A = 25°C, input t_r, t_f = 20 ns, C_L = 50 pF, R_L = 200 kΩ

Symbol	Parameter	Conditions	Min	Typ	Max	Units
t _{PLH} , t _{PHL}	Propagation Delay Time	V _{DD} = 5V V _{DD} = 10V V _{DD} = 15V		240 100 70	350 175 140	ns
t _{THL} , t _{TLH}	Transition Time	V _{DD} = 5V V _{DD} = 10V V _{DD} = 15V		100 50 40	200 100 80	ns
f _{CL}	Maximum Clock Input Frequency	V _{DD} = 5V V _{DD} = 10V V _{DD} = 15V	2.5 5 8	3.5 10 16		MHz
t _W	Minimum Clock Pulse Width	V _{DD} = 5V V _{DD} = 10V V _{DD} = 15V		100 50 40	200 100 80	ns
t _{rCL} , t _{fCL}	Clock Rise and Fall Time (Note 6)	V _{DD} = 5V V _{DD} = 10V V _{DD} = 15V			15 15 15	μs
t _s	Minimum Set-Up Time					
	Serial Input t _H ≥ 200 ns (Ref. to CL)	V _{DD} = 5V V _{DD} = 10V V _{DD} = 15V		60 40 30	120 80 60	ns
	Parallel Inputs t _H ≥ 200 ns (Ref. to P/S)	V _{DD} = 5V V _{DD} = 10V V _{DD} = 15V		25 15 10	50 30 20	ns
t _H	Minimum Hold Time	V _{DD} = 5V			0	
	Serial In, Parallel In, t _s ≥ 400 ns	V _{DD} = 10V			10	ns
	Parallel/Serial Control	V _{DD} = 15V			15	
t _{WH}	Minimum P/S Pulse Width	V _{DD} = 5V		150	250	
		V _{DD} = 10V		75	125	ns
		V _{DD} = 15V		50	100	
t _{REM}	Minimum P/S Removal Time (Ref. to CL)	V _{DD} = 5V		100	200	
		V _{DD} = 10V		50	100	ns
		V _{DD} = 15V		40	80	
C _I	Average Input Capacitance	Any Input		5	7.5	pF
C _{PD}	Power Dissipation Capacitance (Note 8)			100		pF

Note 6: AC Parameters are guaranteed by DC correlated testing.**Note 7:** If more than one unit is cascaded t_{rCL} should be made less than or equal to the fixed propagation delay of the output of the driving stage for the estimated capacitive load.**Note 8:** C_{PD} determines the no load AC power consumption of any CMOS device. For complete explanation, see 74C family characteristics application note AN-90.

Typical Performance Characteristics

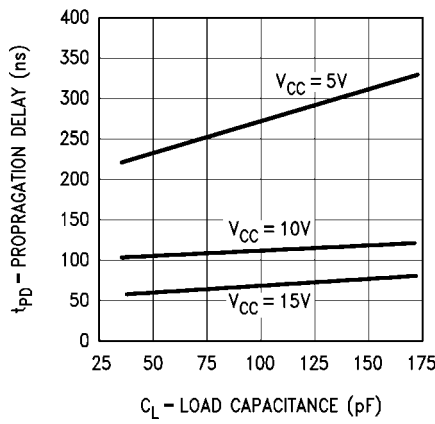
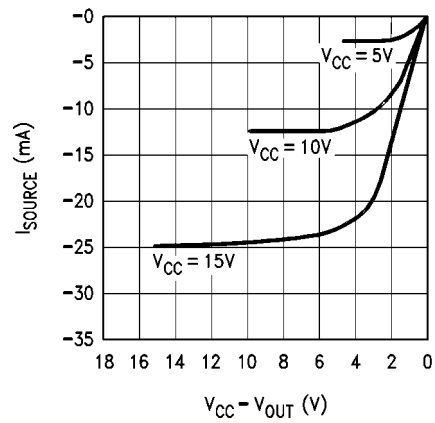
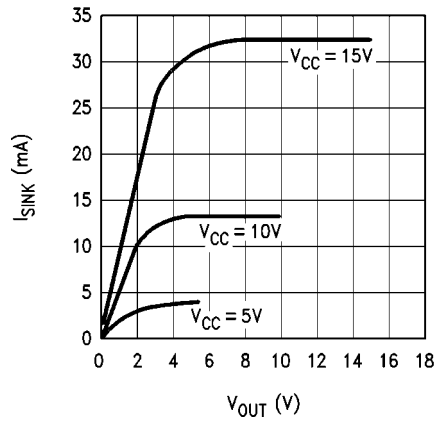

Physical Dimensions inches (millimeters) unless otherwise noted

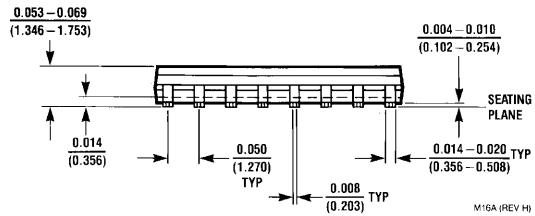
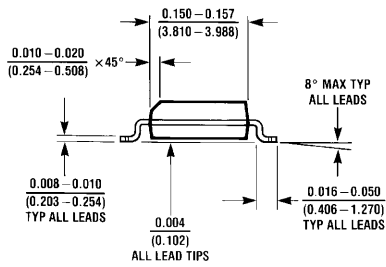
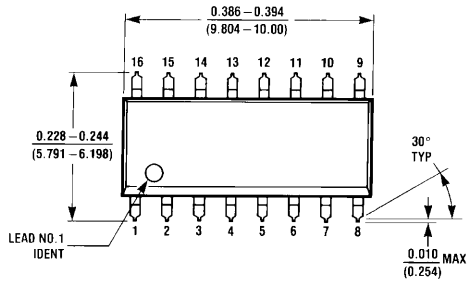

**16-Lead Small Outline Integrated Circuit (SOIC), JEDEC MS-012, 0.150" Narrow
Package Number M16A**

M16A (REV H)

