

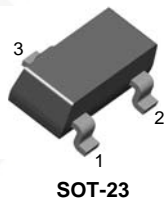

November 2014

MMBD4148 / MMBD4148SE / MMBD4148CC / MMBD4148CA Small Signal Diode



Connection Diagram

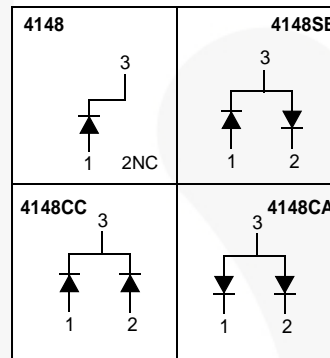

Ordering Information

| Part Number | Top Mark | Package | Packing Method |
|---------------|----------|-----------|----------------|
| MMBD4148 | 5H | SOT-23 3L | Tape and Reel |
| MMBD4148_D87Z | 5H | SOT-23 3L | Tape and Reel |
| MMBD4148SE | D4 | SOT-23 3L | Tape and Reel |
| MMBD4148CC | D5 | SOT-23 3L | Tape and Reel |
| MMBD4148CA | D6 | SOT-23 3L | Tape and Reel |

Absolute Maximum Ratings

Stresses exceeding the absolute maximum ratings may damage the device. The device may not function or be operable above the recommended operating conditions and stressing the parts to these levels is not recommended. In addition, extended exposure to stresses above the recommended operating conditions may affect device reliability. The absolute maximum ratings are stress ratings only. Values are at $T_A = 25^\circ\text{C}$ unless otherwise noted.

| Symbol | Parameter | | Value | Unit |
|-------------|---|-------------------------------|-------------|------------------|
| V_{RRM} | Maximum Repetitive Reverse Voltage | | 100 | V |
| $I_{F(AV)}$ | Average Rectified Forward Current | | 200 | mA |
| I_{FSM} | Non-Repetitive Peak Forward Surge Current | Pulse Width = 1.0 second | 1.0 | A |
| | | Pulse Width = 1.0 microsecond | 2.0 | |
| T_{STG} | Storage Temperature Range | | -55 to +150 | $^\circ\text{C}$ |
| T_J | Operating Junction Temperature | | 150 | $^\circ\text{C}$ |

MMBD4148 / MMBD4148SE / MMBD4148CC / MMBD4148CA — Small Signal Diode

Thermal Characteristics

Values are at $T_A = 25^\circ\text{C}$ unless otherwise noted.

| Symbol | Parameter | Value | Unit |
|-----------------|---|-------|---------------------------|
| P_D | Power Dissipation | 350 | mW |
| $R_{\theta JA}$ | Thermal Resistance, Junction-to-Ambient | 357 | $^\circ\text{C}/\text{W}$ |

Electrical Characteristics

Values are at $T_A = 25^\circ\text{C}$ unless otherwise noted.

| Symbol | Parameter | Conditions | Min. | Max. | Unit |
|----------|-------------------------|---|------|------|---------------|
| V_R | Breakdown Voltage | $I_R = 5.0 \mu\text{A}$ | 75 | | V |
| | | $I_R = 100 \mu\text{A}$ | 100 | | |
| V_F | Forward Voltage | $I_F = 10 \text{ mA}$ | | 1.0 | V |
| I_R | Reverse Leakage Current | $V_R = 20 \text{ V}$ | | 25 | nA |
| | | $V_R = 20 \text{ V}, T_A = 150^\circ\text{C}$ | | 50 | μA |
| | | $V_R = 75 \text{ V}$ | | 5.0 | μA |
| C_T | Total Capacitance | $V_R = 0 \text{ V}, f = 1.0 \text{ MHz}$ | | 4.0 | pF |
| t_{rr} | Reverse Recovery Time | $I_F = 10 \text{ mA}, V_R = 6.0 \text{ V}, I_{RR} = 1.0 \text{ mA}, R_L = 100 \Omega$ | | 4.0 | ns |

Typical Performance Characteristics

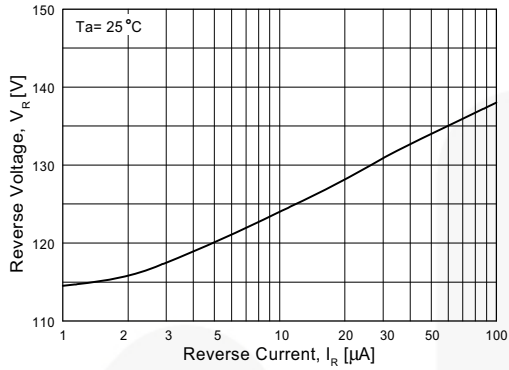

Figure 1. Reverse Voltage vs. Reverse Current
BV - 1.0 to 100 μ A

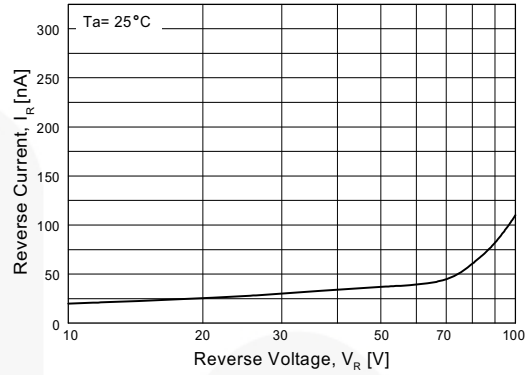

Figure 2. Reverse Current vs. Reverse Voltage
IR - 10 to 100 V

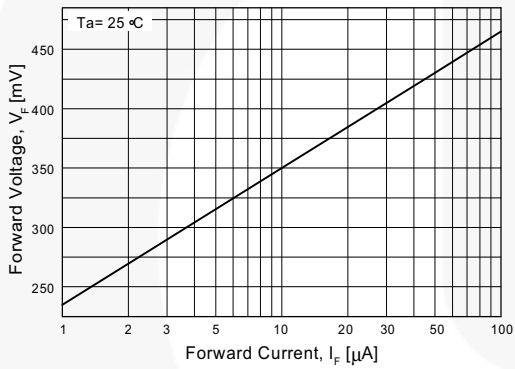

Figure 3. Forward Voltage vs. Forward Current
VF - 1.0 to 100 μ A

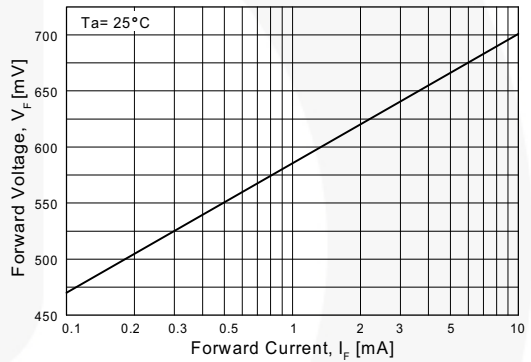

Figure 4. Forward Voltage vs. Forward Current
VF - 0.1 to 10 mA

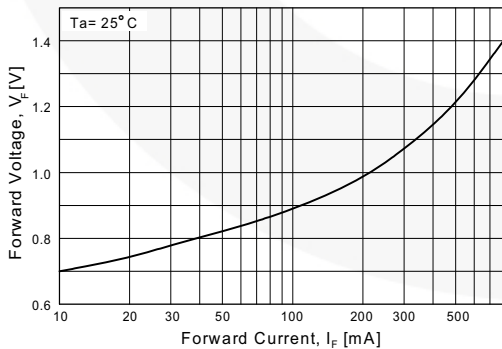

Figure 5. Forward Voltage vs. Forward Current
VF - 10 to 800 mA

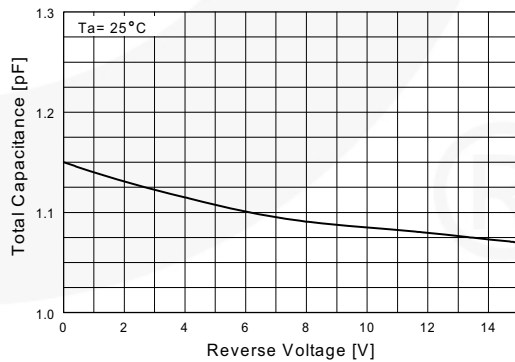

Figure 6. Total Capacitance vs. Reverse Voltage

Typical Performance Characteristics (Continued)

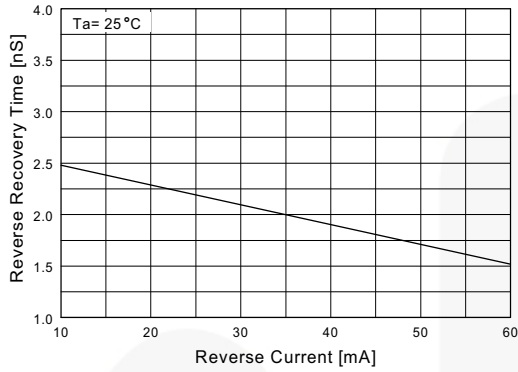

Figure 7. Reverse Recovery Time vs. Reverse Current
TRR - IR 10 mA to 60 mA

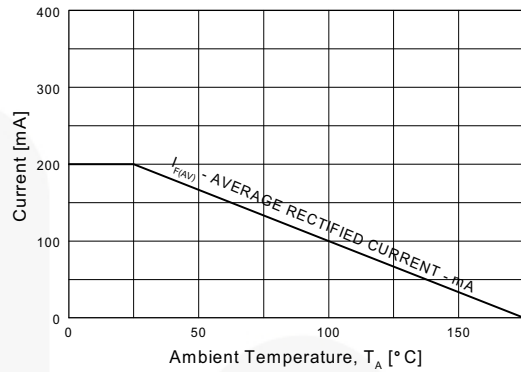

Figure 8. Average Rectified Current ($I_{F(AV)}$)
vs. Ambient Temperature (T_A)

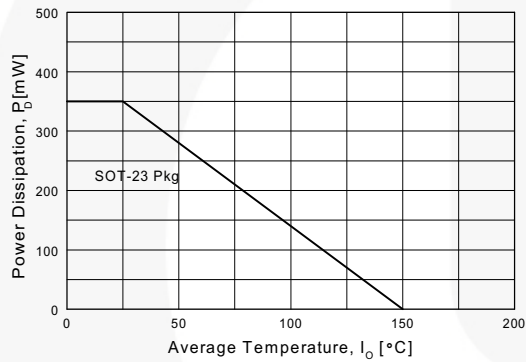
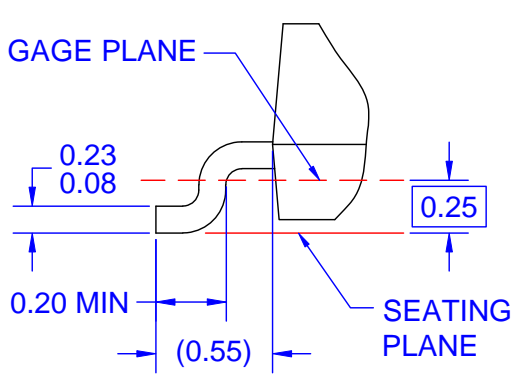
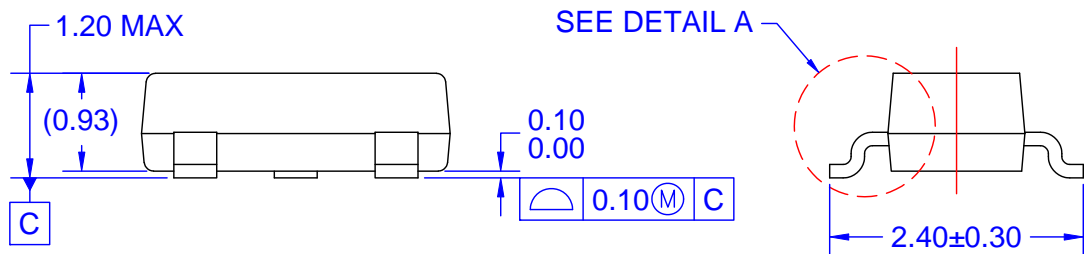
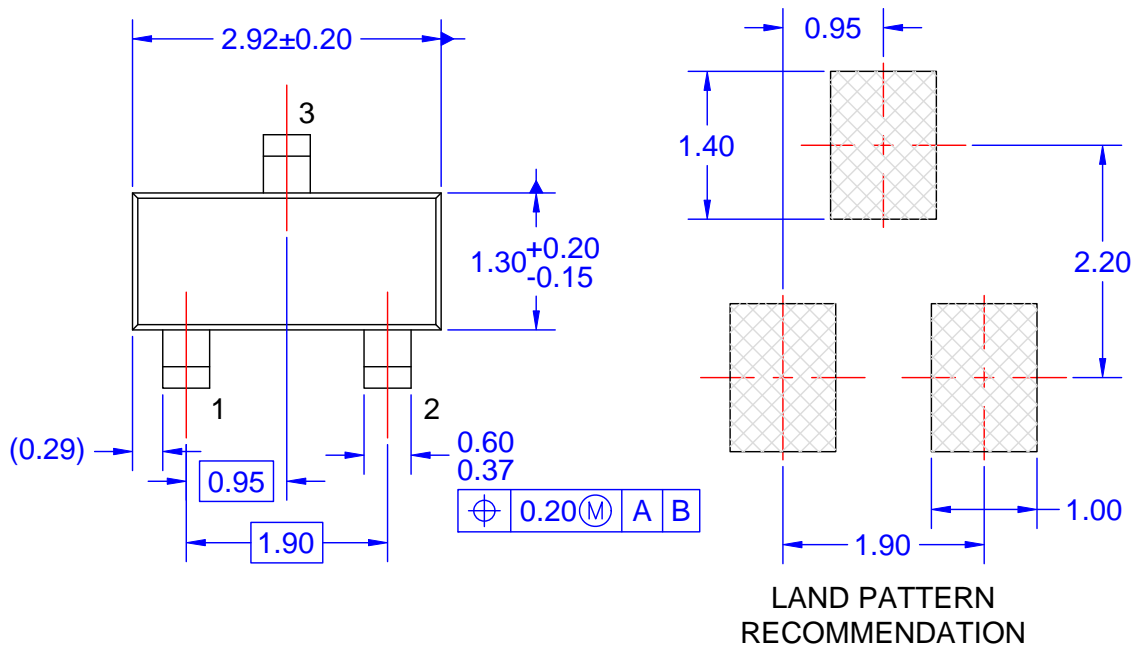

Figure 9. Power Derating Curve



DETAIL A
SCALE: 2X





NOTES: UNLESS OTHERWISE SPECIFIED

- A) REFERENCE JEDEC REGISTRATION TO-236, VARIATION AB, ISSUE H.
- B) ALL DIMENSIONS ARE IN MILLIMETERS.
- C) DIMENSIONS ARE INCLUSIVE OF BURRS, MOLD FLASH AND TIE BAR EXTRUSIONS.
- D) DIMENSIONING AND TOLERANCING PER ASME Y14.5M - 1994.
- E) DRAWING FILE NAME: MA03DREV10



TRADEMARKS

The following includes registered and unregistered trademarks and service marks, owned by Fairchild Semiconductor and/or its global subsidiaries, and is not intended to be an exhaustive list of all such trademarks.

- | | | | |
|---|--|---|---|
| AccuPower™ | F-PFS™ | OPTOPLANAR® |  |
| AttitudeEngine™ | FRFET® |  | TinyBoost® |
| Awinda® | Global Power Resource SM | Power Supply WebDesigner™ | TinyBuck® |
| AX-CAP®* | GreenBridge™ | PowerTrench® | TinyCalc™ |
| BitSiC™ | Green FPS™ | PowerXS™ | TinyLogic® |
| Build it Now™ | Green FPS™ e-Series™ | Programmable Active Droop™ | TINYOPTO™ |
| CorePLUS™ | Gmax™ | QFET® | TinyPower™ |
| CorePOWER™ | GTO™ | QS™ | TinyPWM™ |
| CROSSVOL™ | IntelliMAX™ | Quiet Series™ | TinyWire™ |
| CTL™ | ISOPLANAR™ | RapidConfigure™ | TranSiC™ |
| Current Transfer Logic™ | Making Small Speakers Sound Louder and Better™ |  | TriFault Detect™ |
| DEUXPEED® | MegaBuck™ | Saving our world, 1mW/W/kW at a time™ | TRUECURRENT®* |
| Dual Cool™ | MICROCOUPLER™ | SignalWise™ | μSerDes™ |
| EcoSPARK® | MicroFET™ | SmartMax™ |  |
| EfficientMax™ | MicroPak™ | SMART START™ | UHC® |
| ESBC™ | MicroPak2™ | Solutions for Your Success™ | Ultra FRFET™ |
|  | MillerDrive™ | SPM® | UniFET™ |
| Fairchild® | MotionMax™ | STEALTH™ | VCX™ |
| Fairchild Semiconductor® | MotionGrid® | SuperFET® | VisualMax™ |
| FACT Quiet Series™ | MTI® | SuperSOT™-3 | VoltagePlus™ |
| FACT® | MTX® | SuperSOT™-6 | XS™ |
| FAST® | MVN® | SuperSOT™-8 | Xsens™ |
| FastvCore™ | mWSaver® | SupreMOS® | 仙童™ |
| FETBench™ | OptoHiT™ | SyncFET™ | |
| FPS™ | OPTOLOGIC® | Sync-Lock™ | |

* Trademarks of System General Corporation, used under license by Fairchild Semiconductor.

DISCLAIMER

FAIRCHILD SEMICONDUCTOR RESERVES THE RIGHT TO MAKE CHANGES WITHOUT FURTHER NOTICE TO ANY PRODUCTS HEREIN TO IMPROVE RELIABILITY, FUNCTION, OR DESIGN. TO OBTAIN THE LATEST, MOST UP-TO-DATE DATASHEET AND PRODUCT INFORMATION, VISIT OUR WEBSITE AT [HTTP://WWW.FAIRCHILDSEMI.COM](http://www.fairchildsemi.com). FAIRCHILD DOES NOT ASSUME ANY LIABILITY ARISING OUT OF THE APPLICATION OR USE OF ANY PRODUCT OR CIRCUIT DESCRIBED HEREIN; NEITHER DOES IT CONVEY ANY LICENSE UNDER ITS PATENT RIGHTS, NOR THE RIGHTS OF OTHERS. THESE SPECIFICATIONS DO NOT EXPAND THE TERMS OF FAIRCHILD'S WORLDWIDE TERMS AND CONDITIONS, SPECIFICALLY THE WARRANTY THEREIN, WHICH COVERS THESE PRODUCTS.

LIFE SUPPORT POLICY

FAIRCHILD'S PRODUCTS ARE NOT AUTHORIZED FOR USE AS CRITICAL COMPONENTS IN LIFE SUPPORT DEVICES OR SYSTEMS WITHOUT THE EXPRESS WRITTEN APPROVAL OF FAIRCHILD SEMICONDUCTOR CORPORATION.

As used herein:

1. Life support devices or systems are devices or systems which, (a) are intended for surgical implant into the body or (b) support or sustain life, and (c) whose failure to perform when properly used in accordance with instructions for use provided in the labeling, can be reasonably expected to result in a significant injury of the user.
2. A critical component in any component of a life support, device, or system whose failure to perform can be reasonably expected to cause the failure of the life support device or system, or to affect its safety or effectiveness.

ANTI-COUNTERFEITING POLICY

Fairchild Semiconductor Corporation's Anti-Counterfeiting Policy. Fairchild's Anti-Counterfeiting Policy is also stated on our external website, www.fairchildsemi.com, under Sales Support.

Counterfeiting of semiconductor parts is a growing problem in the industry. All manufacturers of semiconductor products are experiencing counterfeiting of their parts. Customers who inadvertently purchase counterfeit parts experience many problems such as loss of brand reputation, substandard performance, failed applications, and increased cost of production and manufacturing delays. Fairchild is taking strong measures to protect ourselves and our customers from the proliferation of counterfeit parts. Fairchild strongly encourages customers to purchase Fairchild parts either directly from Fairchild or from Authorized Fairchild Distributors who are listed by country on our web page cited above. Products customers buy either from Fairchild directly or from Authorized Fairchild Distributors are genuine parts, have full traceability, meet Fairchild's quality standards for handling and storage and provide access to Fairchild's full range of up-to-date technical and product information. Fairchild and our Authorized Distributors will stand behind all warranties and will appropriately address any warranty issues that may arise. Fairchild will not provide any warranty coverage or other assistance for parts bought from Unauthorized Sources. Fairchild is committed to combat this global problem and encourage our customers to do their part in stopping this practice by buying direct or from authorized distributors.

PRODUCT STATUS DEFINITIONS

Definition of Terms

| Datasheet Identification | Product Status | Definition |
|--------------------------|-----------------------|---|
| Advance Information | Formative / In Design | Datasheet contains the design specifications for product development. Specifications may change in any manner without notice. |
| Preliminary | First Production | Datasheet contains preliminary data; supplementary data will be published at a later date. Fairchild Semiconductor reserves the right to make changes at any time without notice to improve design. |
| No Identification Needed | Full Production | Datasheet contains final specifications. Fairchild Semiconductor reserves the right to make changes at any time without notice to improve the design. |
| Obsolete | Not In Production | Datasheet contains specifications on a product that is discontinued by Fairchild Semiconductor. The datasheet is for reference information only. |