

**BNC Connectors, 75 Ohm (Continued)**

**Press Fit Vertical Metalized Jacks PC Board Mount**  
(Continued)

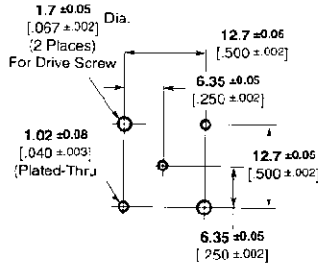
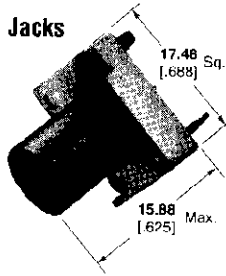

PC Board Thickness (Min.)	Part No.
2.36	221336-3
.093	
3.17	221336-4
.125	

**Recommended PC Board Layout**

**Press Fit, Bulkhead Vertical Metalized Jack includes hardware**

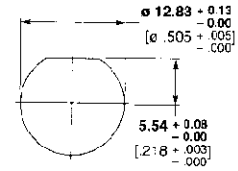
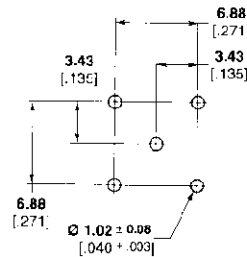
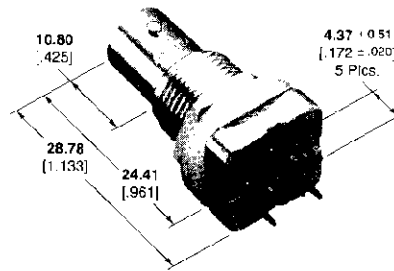

Holes Plated Through 5 Plcs.

**Part No. 1274124-2**

**Recommended PC Board Layout**

**Right Angle Metalized Jacks PC Board Mount**

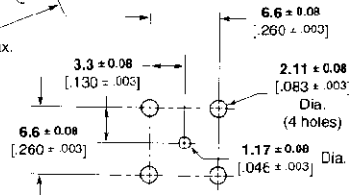
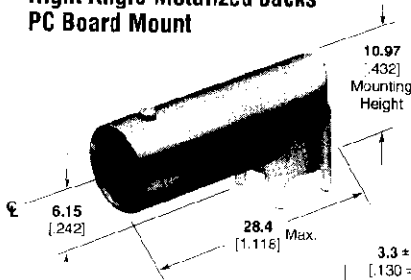

Maximum PC Board Thickness 2.54 [100]

**Recommended PC Board Layout**

Body Plating	Dielectric	Contact Plating	Center Contact Dimension	Length	Part No.
Nickel	TPX	Gold2	.171 [007]	4.34 [171]	413558-1
Tin-Lead	TEFLON	Gold2	.171 [007]	4.34 [171]	413558-2
Nickel	TPX	Gold2	.131 [005]	4.34 [171]	413558-3
Tin-Lead	TPX	Gold1	.171 [007]	4.34 [171]	413558-4
Nickel	TPX	Gold1	.171 [007]	4.34 [171]	413558-5

Gold1 — 0.00076 [000030] thick  
Gold2 — 0.00127 [000050] thick

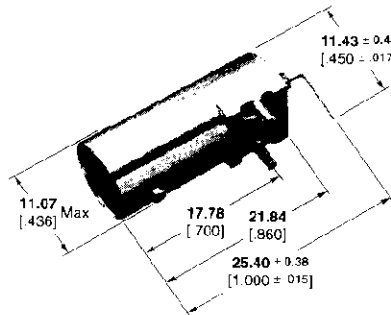

**Part No. 1274127-1**

